

# I MIEI<sup>®</sup> GIOIELLI

ESPOSITORI & DISPLAY

## 2019

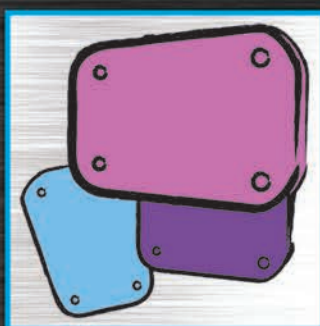
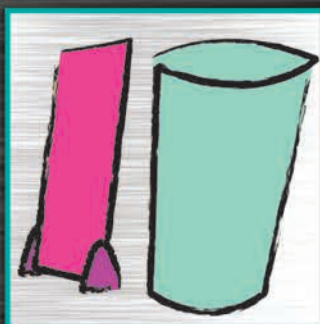
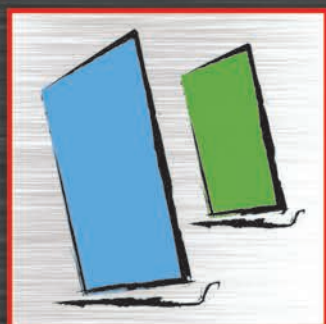

## UNIVERS SYSTEM pag. 5-44

- Basi in Pvc
- Pali Ellisce
- Message A4-A3-B2-B1
- Style Klik-Klak
- Accadisplay
- Swing Antivento
- Expo
- Global
- Standing
- Base
- Base Regolabile
- Elle
- Universal Brochure
- Plex Box
- Flag Brochure
- Nano
- Elite
- Single
- Book
- Segnaletica +Arianna
- Theatre
- Point & Minipoint
- Info
- Note
- Barrier
- Barrier Regolabile
- Newall
- Desk

## ROLL-UP pag. 45-62

- New Roller One 1.0 e 2.0
- New Economy Roller
- New Roller Mono
- Budget Roller Fun
- Elite Roller Fun
- New Roller Fun Plus
- New Supreme Intercambiabile
- Roller Gothic
- Mammuth
- New Roll-up Xxl
- Tech Roller
- Roll-up The Win
- Roller Triangle
- Roller Angle
- Roller Essential
- Roll-up Magnetic
- Roller Bifacciale
- Roller Double
- Plastic Outdoor
- New Outdoor
- Standelle
- X Banner
- Intercambiabile Mini
- Supporti per display, roll-up, pop-up
- Supporti speciali
- Kernow-Jet

## TOTEM pag. 63-76

- Totem Arianna Style
- New Big Totem da esterno
- New Big Totem
- Sistema Alice
- Expo Alice
- Totem Luminoso
- Totem Piuma
- New Onda Totem
- Onda Info
- Totem Quadro & Ellisce
- Totem Alluminio
- Totem Prisma
- Totem Prisma Quadro
- Totem Tris
- Totem Kartoon

## CORNICI pag. 77-108

- Opti Klik-Klak
- Eco Klik-Klak
- Klik-Klak
- Cornice Slide
- Windows Frame
- Klik-Klak Glass
- Cornici Alustyle
- Cornici
- Cornici Aluframe
- Poster Snap
- Poster Clamp
- Strech Frame
- Expoframe
- Lavagna Perspex
- Magnetic Lightbox
- Bachecca
- Bachecca Plus
- Banner Box 60/125
- Cornici Textile
- Eco Ledbox
- Lite Ledbox
- Lite Ledbox Outdoor
- Slim Ledbox
- Magneto Ledbox
- Moonlight Ledbox
- Moonlight Magneto Led
- Bachecca Notes/Led

## CAVALLETTI pag. 109-120

- Espositori Cavalletto
- A&B Display HD
- Eco Expo klik-klak
- Cavalletto Compact
- Cavalletto Slide
- Avenue
- Square
- Cavalletto Art
- Café Barrier
- New Bistrò
- Risto in alluminio
- Cavalletti Lavagna
- New Eliminacode
- Bordocampo Metal
- Bordocampo Plast

## ESPOSITORI pag. 121-148

- Infoexpo & Infoexpo Style
- Infotasca
- Segnaposti
- Expoplex Economy
- Expoplex da banco/parete
- Tasca Vision
- Wall Unit
- Plex Box
- Metal Depliant
- Steel Depliant
- US Plex Box
- Zick-Zack
- Velaplex
- Clear Frame
- Serie Podio
- Cesto Globe
- Dual Plate
- Tourist Signal
- Automotive
- Flexible
- Flexible Led
- Zeta Perspex
- Elle Perspex
- Slim Depliant & Slim Info

## SEGNALETICA pag. 149-178

- Economy Sistema Arianna
- Arianna Light
- Targhe Industry
- Targhe Alluminio
- Sistema Delta
- Tuttotarghe Style
- Tuttotarghe
- Distanziali
- Staffe targhe parete/bandiera
- Portatarga Led
- US Standing
- Sistemi di fissaggio a sospensione
- Sistemi di fissaggio tiranti
- Sistemi di fissaggio Acciaio/Elite
- Velaplex
- Sistemi di fissaggio rigido
- Sistemi di fissaggio quadri
- Magnetic Lightbox

## BANDIERE pag. 179-196

- Flying Banner kit
- Flying Base
- Accessori Flying Banner Kit
- Spinner Flag
- Wind Flag
- New Flag
- Banner Flag
- Metal Flag
- Tripole
- Gigaflag
- Border, Corner, Angle Flag
- Banner Stand & Maxi
- Kingflag

## PORTAPANNELLI pag. 197-204

- Invisibile Classic, Quadro e XXQuadro
- Piedistallo Tondo
- Piedistallo Ellisce
- Maxi Piede
- Portapannelli Wing
- Europiede
- Portapannelli Freccia
- Portapannelli Perspex
- Flap
- Base Plast

## DESK-BANCHETTI pag. 205-212

- New Promostand
- Promoluna
- New Aluxbanco
- Aluxbanco Plus
- Ecodesk
- Promodesk
- Pop Desk
- Pop Arco
- Ondatable
- Ondatable Tondo
- US Desk

## LASTRE-PROFILI ACCESSORI - LED pag. 213-242

- Lastre Piuma
- Fogli
- Pvc-Pp-Pet-Pst
- Lastre Pvc Espanso
- Lastre Polionda
- Lastre Metacrilato
- Lastre Kartoon
- Lastre Eurobond
- Supporti da Parati Digitali
- Carta transfer per stampanti laser
- Supporti laser pre-fustellati
- Biadesivi
- Appendini
- Gancio e Uncino
- Profili Alu e Plast
- Profili Techno
- Quadrotratto
- Cassonetti Led
- Punte per frese CNC
- Lettere a specchio
- Pannelli rasterizzati
- Lettere in Pvc Espanso
- Lettere per retroilluminazione

## FONDALI-PARETI pag. 243-255

- Crown
- Pop-up Textile
- Pop-up Polionda
- Fisarmonica Classic e Separè
- The Wall
- Pop-up Quick Fix
- Ricambi e accessori Pop-up
- Supporti Pop-up

# INDICE

A e B display HD	pag. 111	Lastre Karton	pag. 220	Slim Ledbox	pag. 106
Accessori flying banner kit	pag. 184	Lastre Metacrilato	pag. 219	Spinner Flag	pag. 184
Aluxbanco Plus	pag. 208	Lastre Polionda	pag. 218	Square	pag. 114
Angle Flag	pag. 190	Lastre pvc Espanso	pag. 217	Staffa per targhe a parete e bandiera	pag. 169
Appendini	pag. 227	Lavagna perspex	pag. 92	Standelle	pag. 59
Automotive	pag. 136	Lettere a specchio	pag. 239	Steel Depliant	pag. 131
Avenue	pag. 114	Lettere in pvc espanso	pag. 241	Strech Frame	pag. 91
Bacheca Notes	pag. 96	Lettere per retroilluminazione	pag. 242	Supporti da Parati Digitali	pag. 222
Bacheca Notes Led	pag. 96	Lite Ledbox Outdoor	pag. 105	Supporti Laser pre-fustellati	pag. 225
Bacheca	pag. 97	Lite Ledbox	pag. 104	Supporti per display/roll-up/pop-up	pag. 61/255
Bacheca Plus	pag. 97	Magnetic Light Box	pag. 93/178	Supporti speciali Kernow-Jet	pag. 62
Banner Box 60	pag. 98	Magneto Ledbox	pag. 107	Supreme Intercambiabile	pag. 51
Banner Box 125	pag. 100	Mammuth	pag. 52	Targhe Alluminio	pag. 154
Banner Flag	pag. 187	Maxi Piede	pag. 200	Targhe Industry	pag. 152
Banner Stand & Maxi	pag. 192	Metal Depliant	pag. 131	Tasca Vision	pag. 128
Biadesivi	pag. 226	Metal Flag	pag. 187	Tech Roller	pag. 54
Border Flag	pag. 190	Moonlight Ledbox	pag. 108	The Wall	pag. 250
Bordocampo Metal	pag. 120	Moonlight Magneto Led	pag. 108	Totem Alluminio	pag. 73
Bordocampo Plast	pag. 120	New Aluxbanco	pag. 207	Totem Arianna style	pag. 64
Budget Roller Fun	pag. 49	New Big Totem	pag. 67	Totem Karton	pag. 76
Café Barrier	pag. 115	New Big Totem per esterno	pag. 66	Totem Luminoso	pag. 70
Carta transfer per stampanti laser	pag. 224	New Bistrò in legno	pag. 116	Totem Piuma	pag. 71
Cassonetti Luminosi Monofacciali	pag. 234	New EliminaCode	pag. 118	Totem Prisma Quadro	pag. 74
Cassonetti Luminosi Bifacciali	pag. 236	New Flag	pag. 186	Totem Prisma	pag. 74
Cavalletti lavagna	pag. 117	New Onda Totem	pag. 72	Totem Quadro e Ellisse	pag. 73
Cavalletto Art	pag. 115	New Outdoor	pag. 58	Totem Tris	pag. 75
Cavalletto Compact	pag. 113	New Promostand	pag. 206	Tourist Signal	pag. 136
Cavalletto Slide	pag. 113	Ondatable	pag. 211	Tripole	pag. 188
Cesto Globe	pag. 134	Ondatable Tondo	pag. 211	Tuttotarghe	pag. 162
Clear Frame	pag. 133	Onda Info	pag. 72	Tuttotarghe Style	pag. 159
Corner Flag	pag. 190	Opti klik klak	pag. 78	Velaplex	pag. 133/175
Cornice slide	pag. 83	Pannelli rasterizzati	pag. 240	Wall Unit	pag. 130
Cornici Alustyle mod. A	pag. 86	Piedistallo Ellisse	pag. 199	Wind Flag	pag. 185
Cornici Alustyle mod. B	pag. 87	Piedistallo Tondo	pag. 199	Windows Frame	pag. 84
Cornici a scomparsa	pag. 88	Plastic Outdoor	pag. 58	X Banner	pag. 60
Cornici Aluframe	pag. 90	Plex Box	pag. 130	Zeta Perspex	pag. 138
Cornici Textile	pag. 102	Pop Arco	pag. 210	Zick Zack	pag. 132
Crown	pag. 244	Pop Desk	pag. 210		
Distanziali	pag. 164	Pop up Polionda	pag. 248		
Dual Plate	pag. 135	Pop up Quick Fix	pag. 251		
Eco Expo klik klak	pag. 112	Pop up Textile	pag. 247		
Eco klik klak anti-effrazione	pag. 82	Portapannelli Freccia	pag. 203		
Eco klik klak nero-cromo-acciaio	pag. 81	Portapannelli Perspex	pag. 203		
Eco klik klak wateproof	pag. 82	Portapannelli Wing	pag. 201		
Eco klik klak	pag. 80	Portatarga Led	pag. 169		
Eco Ledbox	pag. 103	Poster Clamp	pag. 91		
Economy Roller	pag. 47	Poster Snap	pag. 91		
Economy Sistema Arianna Light	pag. 151	Profili Alu e Plast	pag. 229		
Economy Sistema Arianna	pag. 150	Profili Techno	pag. 230		
Elle Perspex	pag. 141	Promodesk	pag. 209		
Ecodesk	pag. 209	Promoluna	pag. 207		
Elite Roller Fun	pag. 49	Punte per frese C.N.C.	pag. 238		
Espositori Cavalletto	pag. 110	Quadrotratto	pag. 233		
Europiede	pag. 202	Ricambi e Accessori Pop up	pag. 255		
Expo Alice	pag. 69	Risto in alluminio	pag. 116		
Expoframe	pag. 92	Roll up Magnetic	pag. 56		
Expoplex Economy da banco/parete	pag. 124	Roll up The Win	pag. 54		
Expoplex da banco	pag. 126	Roller Angle	pag. 55		
Expoplex da parete	pag. 129	Roller Bifacciale	pag. 57		
Fisarmonica Classic & Separè	pag. 249	Roller Double	pag. 57		
Flag Base	pag. 199	Roller Essential	pag. 56		
Flap	pag. 204	Roller Fun Plus	pag. 50		
Flexible	pag. 137	Roller Gothic	pag. 52		
Flexible Led	pag. 137	Roller Mono	pag. 48		
Flying Banner kit	pag. 180	Roller One 1.0 e 2.0	pag. 46		
Flying Base	pag. 181	Roller Triangle	pag. 55		
Fogli pvc-pp-pet-pst	pag. 216	Roll up Xxl	pag. 53		
Gancio e Uncino	pag. 228	Segnaposti	pag. 123		
Gigaflag	pag. 189	Serie Podio	pag. 134		
Infoexpo e Infoexpo Style	pag. 122	Sistema Alice	pag. 68		
Infotasca	pag. 123	Sistema Arianna	pag. 152		
Intercambiabile Mini	pag. 60	Sistema Arianna Light	pag. 153		
Invisibile Classic, Quadro & XXQuadro	pag. 198	Sistema Delta	pag. 156		
Kingflag	pag. 193	Sistemi di fissaggio a sospensione	pag. 172		
Klik klak Glass	pag. 84	Sistemi di fissaggio Acciaio e Elite	pag. 174		
Klik klak su misura	pag. 85	Sistemi di fissaggio con tiranti	pag. 173		
Klik klak	pag. 83	Sistemi di fissaggio quadri	pag. 177		
Lastre Piuma	pag. 214	Sistemi di fissaggio rigido	pag. 176		
Lastre Eurobond	pag. 221	Slim Depliant & Slim Info	pag. 146		

## Univers System

• Accadisplay	pag. 23
• Barrier	pag. 38
• Barrier regolabile	pag. 39
• Base	pag. 28
• Base Regolabile	pag. 29
• Basi e Zavorre in pvc-hd	pag. 8
• Book	pag. 34
• Desk	pag. 42/212
• Elite	pag. 33
• Elle	pag. 29
• Expo	pag. 24
• Flag Brochure	pag. 32
• Global	pag. 25
• Info	pag. 37
• Message A4-A3-B2-B1	pag. 10
• Nano	pag. 33
• Newall	pag. 40
• Note	pag. 37
• Note Led	pag. 44
• Pali Ellisse	pag. 9
• Plex Box	pag. 32/132
• Point & Minipoint	pag. 36
• Point & Minipoint Led	pag. 44
• Segnaletica + Arianna	pag. 35
• Single	pag. 34
• Standing	pag. 26/170
• Style klik klak	pag. 22
• Style Led	pag. 43
• Swing Antivento	pag. 23
• Theatre	pag. 35
• Universal Brochure	pag. 30

# LE NOSTRE TECNOLOGIE...



# ...AL VOSTRO SERVIZIO

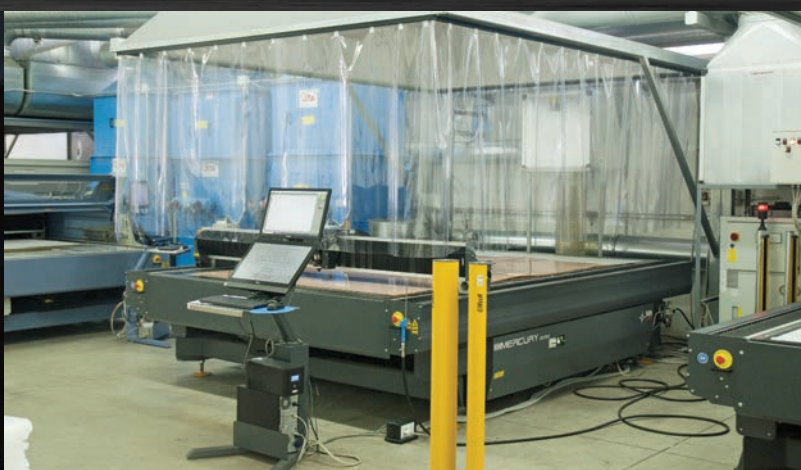
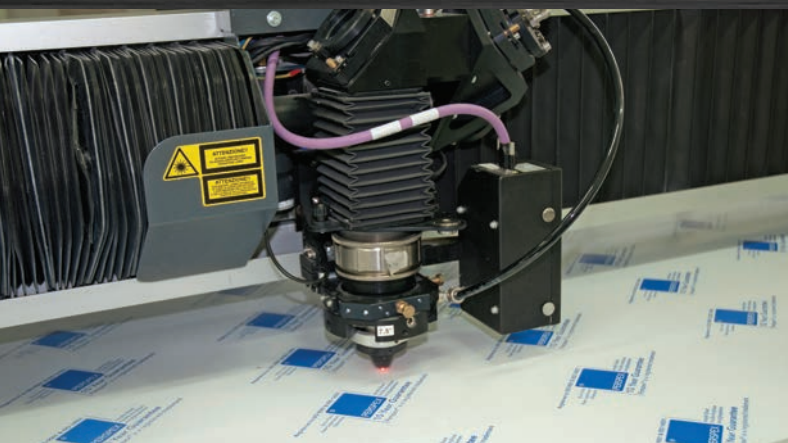
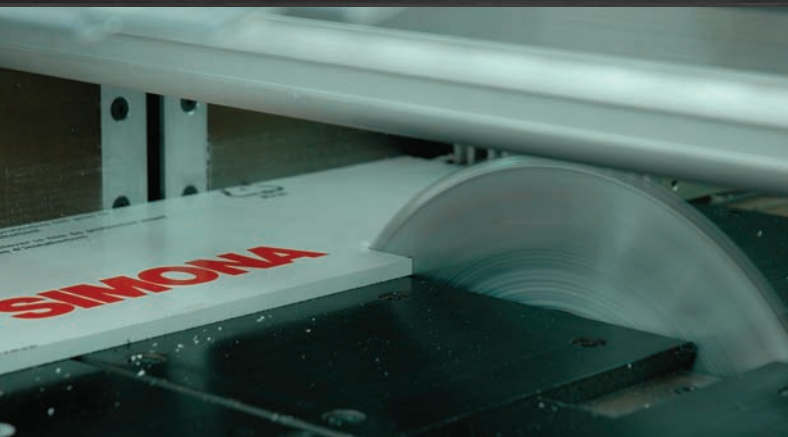



[www.imieigioielli.com](http://www.imieigioielli.com)

[www.eurmoma.it](http://www.eurmoma.it)

**QUALITÀ, PER NOI UNO STILE DI VITA.  
QUALITY, FOR US A LIFESTYLE.**

Da sempre svolgiamo la nostra attività spendendo una gran parte delle energie per riuscire a fornire prodotti e servizi con uno standard qualitativo sempre ai massimi livelli: un tratto distintivo che ci qualifica da sempre, e che ha contribuito nel tempo ad individuarci come azienda di grande affidabilità.

*Always we conduct our business by spending a great deal of energy to be able to provide products and services with quality standards at the highest levels: a trait that defines us forever, and that has contributed over time to recognize us as a company of great reliability.*

**TROVARE SOLUZIONI, UN OBIETTIVO.  
FIND SOLUTIONS, THE TARGET.**

Risolvere problemi fa parte del nostro quotidiano: una sfida che si ripete, mai uguale a se stessa, e che ci permette di migliorare in continuazione attraverso un confronto continuo ed una consulenza mirata. Per ogni esigenza, abbiamo sempre la soluzione migliore.

*Solving problems is part of our daily life: a challenge that is repeated, never equal to itself, and that allows us to improve constantly through continuous dialogue and targeted advice. For every need, we have always the best solution.*

**RICERCA, SVILUPPO E...  
RESEARCH, DEVELOPMENT AND...**

L'innovazione è un fenomeno al contempo semplice e complesso: a volte risiede nei particolari, altre volte coinvolge un intero prodotto; a volte si concentra sui materiali, altre sul design. Ma la vera genialità è nel saper combinare queste variabili, concretizzando l'idea di partenza nel migliore equilibrio tra esigenze di mercato e spinta innovativa. Soltanto in questo modo si crea qualcosa di bello, che sia anche utile.

*Innovation is a phenomenon both simple and complex: sometimes resides in the details, and sometimes involves an entire product; sometimes it focuses on materials, on the other design. But the real genius lies in being able to combine these variables, realizing the original idea in the best balance between market needs and innovative drive. Only in this way you create something beautiful, it is also useful.*

**LE IDEE PRENDONO VITA.  
IDEAS COME ALIVE.**

Un conto è pensarlo, un altro disegnarlo, ma alla fine devi realizzarlo: dal brain storming dove spuntano le idee più originali ed inedite, alla fase finale in cui le stesse prendono vita, passo dopo passo. Un processo mai regolare, reso possibile grazie ad un connubio di alte competenze artigianali e macchinari tecnologicamente avanzati in grado di stare al passo della mente più vulcanica ed imprevedibile: la tradizione manifatturiera italiana si fonde con il progresso più avanzato, per un risultato unico ed irripetibile che sfiora la perfezione.

*It is one thing to think, another draw, but in the end you have to make it happen: from brainstorming ideas sprouting most original and unpublished, the final phase in which they come to life, step by step. A process never regular, made possible thanks to a combination of craft skills and high tech machinery able to stay ahead of the mind more volcanic and unpredictable: the Italian manufacturing tradition blends with the most advanced progress, for a result unique and unrepeatable that close to perfection.*

**SULL'ALTARE DEL GUSTO E DELL'ESTETICA.  
ON THE ALTAR OF TASTE AND AESTHETICS.**

La conditio sine qua non è unica ed inequivocabile: in ogni singolo prodotto deve essere rispecchiata l'intera tradizione artistica italiana, il gusto del bello, l'eleganza e l'attenzione per i minimi particolari che hanno reso fino ad oggi famosi ed ineguagliati i nostri canoni stilistici. Tutto ciò per una mission semplice e diretta, che si riassume nel voler fornire non un semplice prodotto, ma un'opera d'arte.

*The prerequisite is unique and unequivocal: in each product must be mirrored the entire Italian artistic tradition, the taste for beauty, elegance and attention to the detail that has made famous to this day and the unmatched our stylistic canons. All this for a simple and direct mission, which is summed up in wanting to shop provide not just a product, but a work of art.*

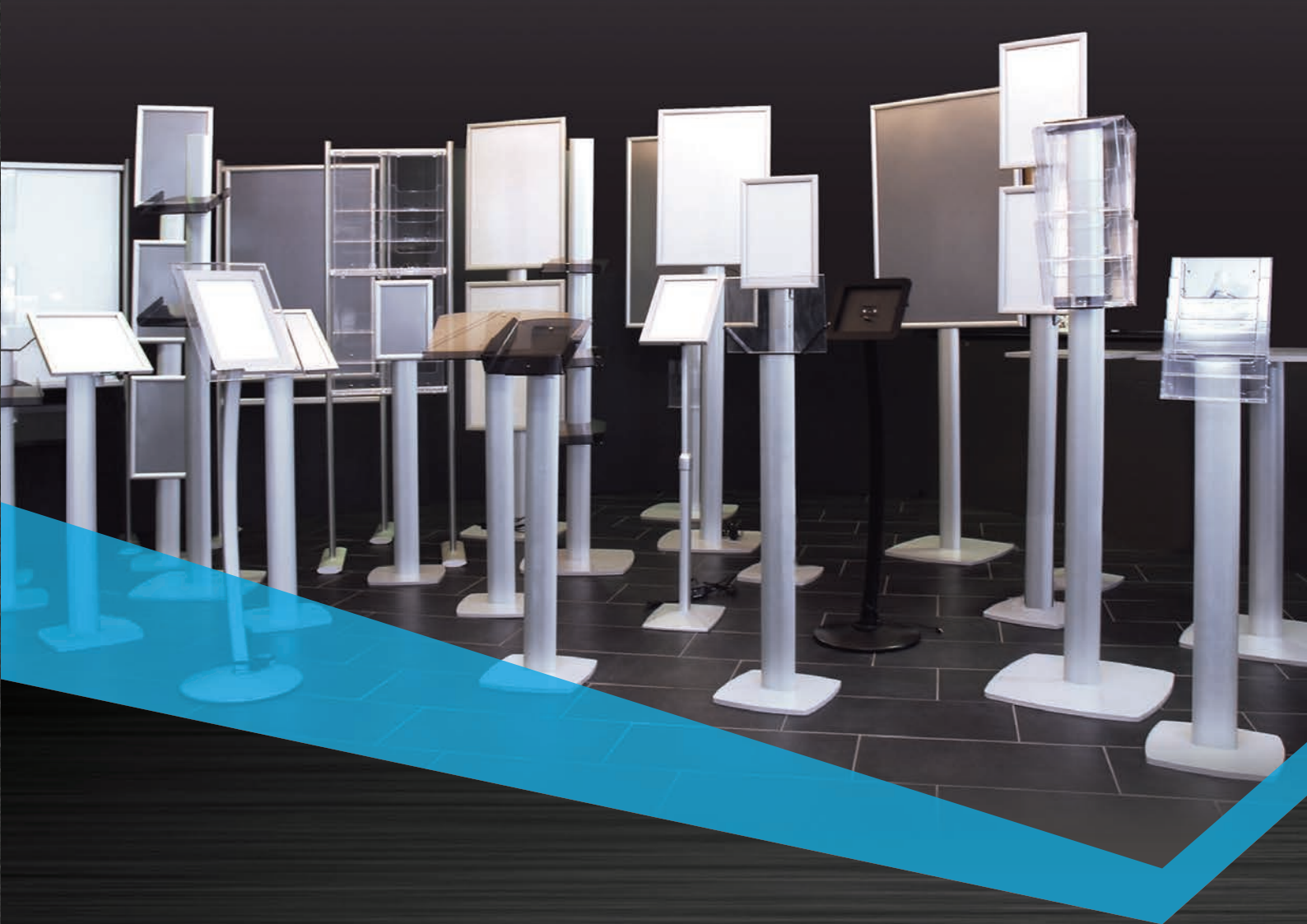

# UNIVERS SYSTEM

**Una semplice idea, un grande progetto.**

L'estetica ed i materiali della linea Univers System sono capaci di conquistare, in un gioco emozionale di sensi, fin dal primo sguardo: rimarrete colpiti da un'esperienza di prodotto unica.

La nuova linea Univers System infatti è caratterizzata da un aspetto hi-tech minimale e curato nei minimi dettagli, sottile e affusolato, leggero e resistente; ogni singolo accessorio è in un rapporto profondamente armonico con gli altri, andando così a formare un'esperienza d'insieme quanto mai perfetta e gradevole.

Una tipologia di prodotto veramente nuova dunque, concepita e sviluppata per rompere gli schemi e cambiare radicalmente l'aspetto di qualsiasi ambiente in cui viene collocata, trasformandosi in una componente d'arredo in grado di arricchire i vostri spazi, sotto tutti i punti di vista.



# REALIZZA IL TUO DISPLAY



**Scegli le basi**



**Scegli la  
lunghezza  
dei profili**





**Aggiungi gli accessori**

**Cornici LED**

**Led Technology**



**Cornici Klik Klak**



**Tasche portabrochure**

# BASI IN PVC

## PVC HD

Particolarmente resistente a detersivi industriali, saponi e sgrassatori.  
**PRATICAMENTE INATTACCABILE!**

Base realizzata in materiale antiacido resistente a tutti i tipi di saponi e solventi industriali.

Base realized with antacid material resistant to all types of soaps and industrial solvent.

### BASI IN PVC HD

### ZAVORRE IN PVC HD

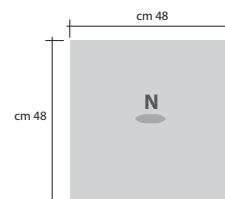
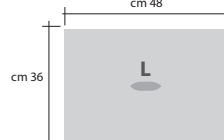
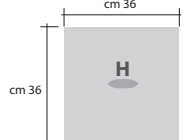
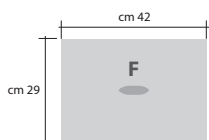
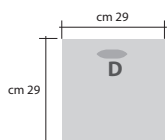
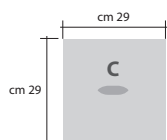
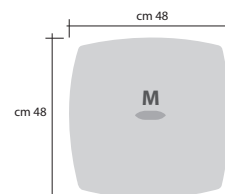
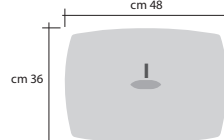
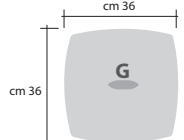
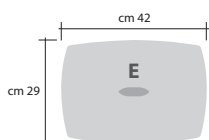
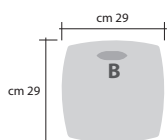
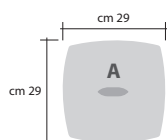
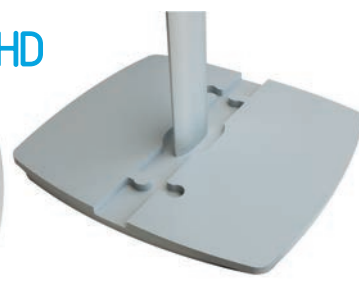
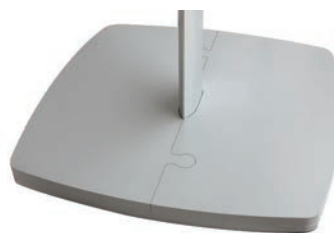
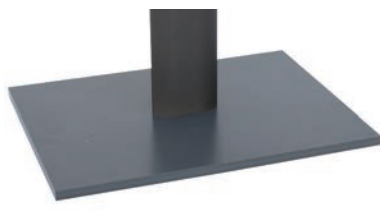
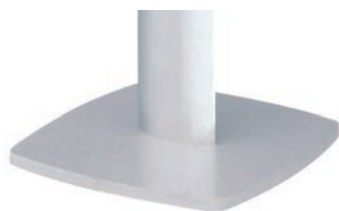

### ZAVORRE IN PVC HD

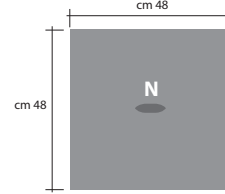
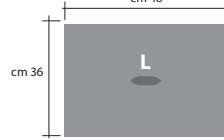
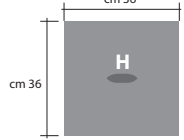
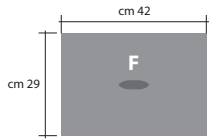
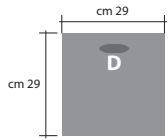
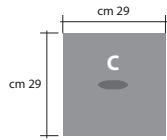
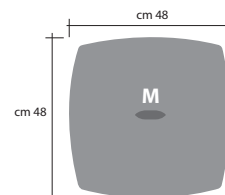
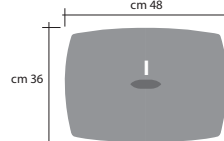
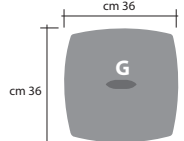
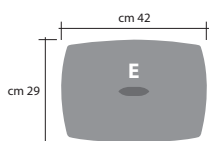
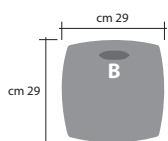
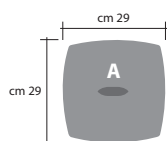
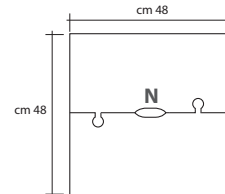
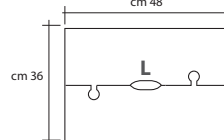
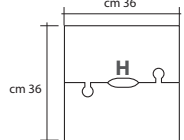
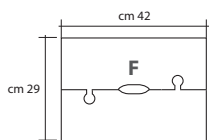
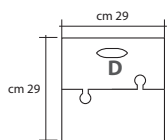
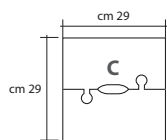
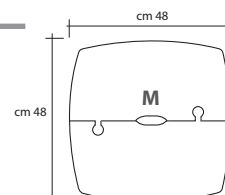
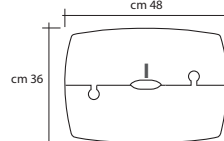
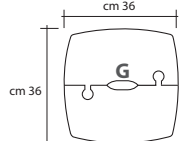
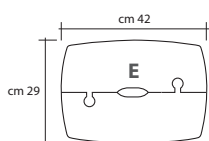
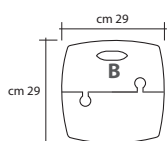
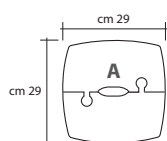

#### SCHEDA TECNICA BASI PVC HD

Codice art.	Codice art.	Descrizione	L.P.
<b>Grigio Chiaro</b>	<b>Grigio Scuro</b>		
EUUSBASEGRA	EUUSBASEANA	Base "A" cm. 29x29	58
EUUSBASEGRB	EUUSBASEANB	Base "B" cm. 29x29	58
EUUSBASEGRC	EUUSBASEANC	Base "C" cm. 29x29	58
EUUSBASEGRD	EUUSBASEAND	Base "D" cm. 29x29	58
EUUSBASEGRE	EUUSBASEANE	Base "E" cm. 29x42	75
EUUSBASEGRF	EUUSBASEANF	Base "F" cm. 29x42	75
EUUSBASEGRG	EUUSBASEANG	Base "G" cm. 36x36	65
EUUSBASEGRH	EUUSBASEANH	Base "H" cm. 36x36	65
EUUSBASEGRI	EUUSBASEANI	Base "I" cm. 36x48	105
EUUSBASEGRM	EUUSBASEANM	Base "M" cm. 48x48	131
EUUSBASEGRN	EUUSBASEANN	Base "N" cm. 48x48	131

#### SCHEDA TECNICA ZAVORRE PVC HD

Codice art.	Codice art.	Descrizione	L.P.
<b>Grigio Chiaro</b>	<b>Grigio Scuro</b>		
EUUSZAVAGRA	EUUSZAVAANA	Zavorra "A" cm. 29x29	58
EUUSZAVAGRB	EUUSZAVAANB	Zavorra "B" cm. 29x29	58
EUUSZAVAGRC	EUUSZAVAANC	Zavorra "C" cm. 29x29	58
EUUSZAVAGRD	EUUSZAVAAND	Zavorra "D" cm. 29x29	58
EUUSZAVAGRE	EUUSZAVAANE	Zavorra "E" cm. 29x42	75
EUUSZAVAGR F	EUUSZAVAANF	Zavorra "F" cm. 29x42	75
EUUSZAVAGRG	EUUSZAVAANG	Zavorra "G" cm. 36x36	65
EUUSZAVAGR H	EUUSZAVAANH	Zavorra "H" cm. 36x36	65
EUUSZAVAGRI	EUUSZAVAANI	Zavorra "I" cm. 36x48	105
EUUSZAVAGR M	EUUSZAVAANM	Zavorra "M" cm. 48x48	131
EUUSZAVAGR N	EUUSZAVAANN	Zavorra "N" cm. 48x48	131

# PALI ELLISSE

Pali in alluminio anodizzato silver o antracite, sezione ellittica, disponibili in diverse misure.  
Anodized aluminum silver or anthracite pole, elliptical section, available in different sizes.

## PALI ELLISSE IN ALL-OXY SILVER

### SCHEDA TECNICA PALO ELLISSE SILVER

Codice art.	Descrizione	L.P.
LTPROEL100	Palo ellisse cm. 100	28
LTPROEL110	Palo ellisse cm. 110	28
LTPROEL120	Palo ellisse cm. 120	32
LTPROEL130	Palo ellisse cm. 130	32
LTPROEL140	Palo ellisse cm. 140	42
LTPROEL150	Palo ellisse cm. 150	42
LTPROEL160	Palo ellisse cm. 160	56
LTPROEL170	Palo ellisse cm. 170	56
LTPROEL180	Palo ellisse cm. 180	56
LTPROEL200	Palo ellisse cm. 200	56
LTPROEL250	Palo ellisse cm. 250	70
LTPROEL300	Palo ellisse cm. 300	84

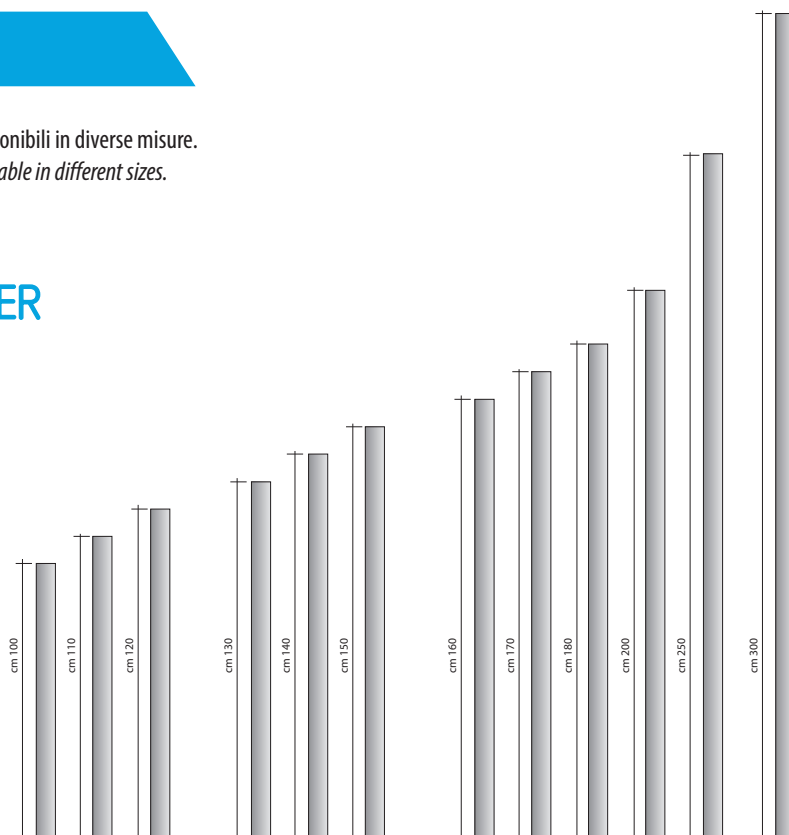

## PALI ELLISSE IN ALL-ANTRACITE

### SCHEDA TECNICA PALO ELLISSE ANTRACITE

Codice art.	Descrizione	L.P.
LTPROELA100	Palo ellisse cm. 100	28
LTPROELA110	Palo ellisse cm. 110	28
LTPROELA120	Palo ellisse cm. 120	32
LTPROELA130	Palo ellisse cm. 130	32
LTPROELA140	Palo ellisse cm. 140	42
LTPROELA150	Palo ellisse cm. 150	42
LTPROELA160	Palo ellisse cm. 160	56
LTPROELA170	Palo ellisse cm. 170	56
LTPROELA180	Palo ellisse cm. 180	56
LTPROELA200	Palo ellisse cm. 200	56
LTPROELA250	Palo ellisse cm. 250	70
LTPROELA300	Palo ellisse cm. 300	84

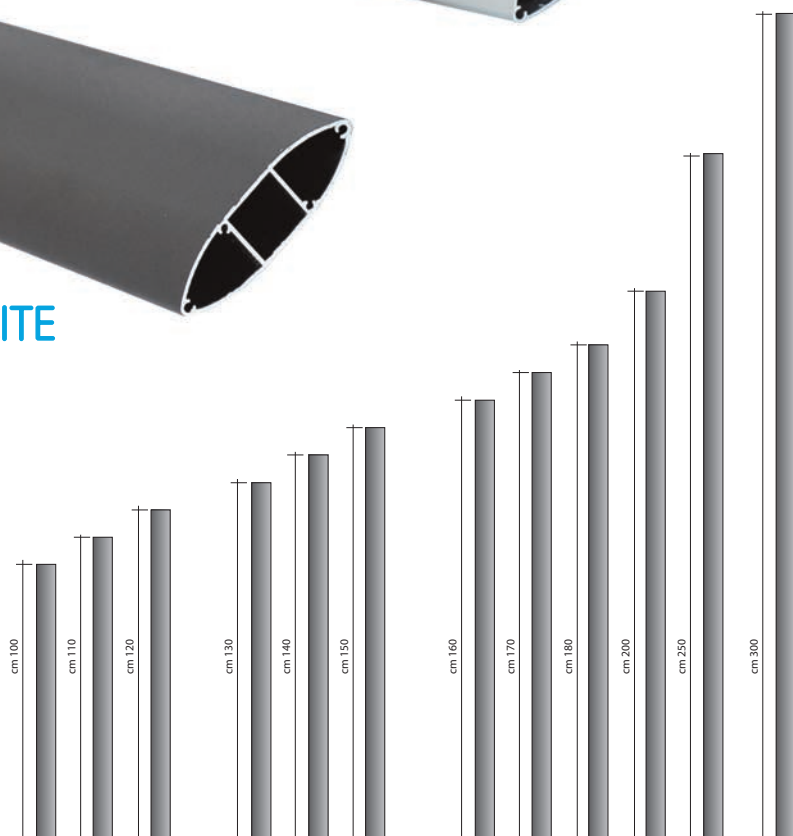

# US MESSAGE A4 - A3 - B2 - B1 CON VERSIONI BROCHURE

Struttura autoportante monofacciale o bifacciale, realizzata in alluminio silver o antracite, e base in PVC-HD, con serie di cornici klik-klak formato A4. Disponibile anche con cornice nera.

*Monofacial or bifacial free-standing structure, realized in silver or anthracite grey aluminium, and PVC-HD base, with series of klik-klak frames A4 size. Also available with black frame.*



## MONOFACCIALI A4 KLIK-KLAK



### SCHEDA TECNICA MESSAGE A4 VERTICALE MONOFACCIALE

Codice art.	Descrizione	L.P.
EUUSM1	2 kilk klak A4 verticale silver	170
EUUSM2	3 klik klak A4 verticale silver	180
EUUSM3	4 klik klak A4 verticale silver	188
EUUSM1AS	2 kilk klak A4 verticale antracite/silver	170
EUUSM2AS	3 kilk klak A4 verticale antracite/silver	180
EUUSM3AS	4 kilk klak A4 verticale antracite/silver	188
EUUSM1A	2 kilk klak A4 verticale antracite	170
EUUSM2A	3 kilk klak A4 verticale antracite	180
EUUSM3A	4 kilk klak A4 verticale antracite	188



### SCHEDA TECNICA MESSAGE A4 ORIZZONTALE MONOFACCIALE

Codice art.	Descrizione	L.P.
EUUSM4	2 kilk klak A4 orizzontale silver	170
EUUSM5	3 klik klak A4 orizzontale silver	180
EUUSM6	4 klik klak A4 orizzontale silver	188
EUUSM4AS	2 kilk klak A4 orizzontale antracite/silver	170
EUUSM5AS	3 kilk klak A4 orizzontale antracite/silver	180
EUUSM6AS	4 kilk klak A4 orizzontale antracite/silver	188
EUUSM4A	2 kilk klak A4 orizzontale antracite	170
EUUSM5A	3 kilk klak A4 orizzontale antracite	180
EUUSM6A	4 kilk klak A4 orizzontale antracite	188

## BIFACCIALI A4 KLIK-KLAK



### SCHEDA TECNICA MESSAGE A4 VERTICALE BIFACCIALE

Codice art.	Descrizione	L.P.
EUUSM7	2+2 kilk klak A4 verticale silver	188
EUUSM8	3+3 klik klak A4 verticale silver	206
EUUSM9	4+4 klik klak A4 verticale silver	226
EUUSM7AS	2+2 kilk klak A4 verticale antracite/silver	188
EUUSM8AS	3+3 kilk klak A4 verticale antracite/silver	206
EUUSM9AS	4+4 kilk klak A4 verticale antracite/silver	226
EUUSM7A	2+2 kilk klak A4 verticale antracite	188
EUUSM8A	3+3 kilk klak A4 verticale antracite	206
EUUSM9A	4+4 kilk klak A4 verticale antracite	226



### SCHEDA TECNICA MESSAGE A4 ORIZZONTALE BIFACCIALE

Codice art.	Descrizione	L.P.
EUUSM10	2+2 kilk klak A4 orizzontale silver	188
EUUSM11	3+3 klik klak A4 orizzontale silver	206
EUUSM12	4+4 klik klak A4 orizzontale silver	226
EUUSM10AS	2+2 kilk klak A4 orizzontale antracite/silver	188
EUUSM11AS	3+3 kilk klak A4 orizzontale antracite/silver	206
EUUSM12AS	4+4 kilk klak A4 orizzontale antracite/silver	226
EUUSM10A	2+2 kilk klak A4 orizzontale antracite	188
EUUSM11A	3+3 kilk klak A4 orizzontale antracite	206
EUUSM12A	4+4 kilk klak A4 orizzontale antracite	226

## MONOFACCIALI A4 KLIK-KLAK



## SCHEDA TECNICA MESSAGE A4 VERTICALE MONOFACCIALE

Codice art.	Descrizione	L.P.
EUUSMB13	2 klik klak A4 +1 brochure 1/3 A4 silver	176
EUUSMB14	2 klik klak A4 +1 brochure A5 silver	180
EUUSMB15	2 klik klak A4 +1 brochure A4 silver	185
EUUSMB13AS	2 klik klak A4 +1 brochure 1/3 A4 antracite/silver	176
EUUSMB14AS	2 klik klak A4 +1 brochure A5 antracite/silver	180
EUUSMB15AS	2 klik klak A4 +1 brochure A4 antracite/silver	185
EUUSMB13A	2 klik klak A4 +1 brochure 1/3 A4 antracite	176
EUUSMB14A	2 klik klak A4 +1 brochure A5 antracite	180
EUUSMB15A	2 klik klak A4 +1 brochure A4 antracite	185



## SCHEDA TECNICA MESSAGE A4 VERTICALE MONOFACCIALE

Codice art.	Descrizione	L.P.
EUUSMB16	2 klik klak A4 +2 brochure 1/3 A4 silver	184
EUUSMB17	2 klik klak A4 +2 brochure A5 silver	195
EUUSMB18	2 klik klak A4 + 2 brochure A4 silver	200
EUUSMB16AS	2 klik klak A4 +2 brochure 1/3 A4 antracite/silver	184
EUUSMB17AS	2 klik klak A4 +2 brochure A5 antracite/ silver	195
EUUSMB18AS	2 klik klak A4 +2 brochure A4 antracite/silver	200
EUUSMB16A	2 klik klak A4 +2 brochure 1/3 A4 antracite	184
EUUSMB17A	2 klik klak A4 +2 brochure A5 antracite	195
EUUSMB18A	2 klik klak A4 +2 brochure A4 antracite	200

## MONOFACCIALI A4 KLIK-KLAK



## SCHEDA TECNICA MESSAGE A4 VERTICALE MONOFACCIALE

Codice art.	Descrizione	L.P.
EUUSMB19	3 klik klak A4 +1 brochure 1/3 A4 silver	186
EUUSMB20	3 klik klak A4 +1 brochure A5 silver	190
EUUSMB21	3 klik klak A4 + 1 brochure A4 silver	194
EUUSMB19AS	3 klik klak A4 +1 brochure 1/3 A4 antracite/silver	186
EUUSMB20AS	3 klik klak A4 +1 brochure A5 antracite/ silver	190
EUUSMB21AS	3 klik klak A4 +1 brochure A4 antracite/silver	194
EUUSMB19A	3 klik klak A4 +1 brochure 1/3 A4 antracite	186
EUUSMB20A	3 klik klak A4 +1 brochure A5 antracite	190
EUUSMB21A	3 klik klak A4 +1 brochure A4 antracite	194



## SCHEDA TECNICA MESSAGE A4 ORIZZONTALE MONOFACCIALE

Codice art.	Descrizione	L.P.
EUUSMB22	2 klik klak A4 +2 brochure 1/3 A4 silver	184
EUUSMB23	2 klik klak A4 +2 brochure A5 silver	192
EUUSMB24	2 klik klak A4 +2 brochure A4 silver	200
EUUSMB22AS	2 klik klak A4 +2 brochure 1/3 A4 antracite/silver	184
EUUSMB23AS	2 klik klak A4 +2 brochure A5 antracite/ silver	192
EUUSMB24AS	2 klik klak A4 +2 brochure A4 antracite/silver	200
EUUSMB22A	2 klik klak A4 +2 brochure 1/3 A4 antracite	184
EUUSMB23A	2 klik klak A4 +2 brochure A5 antracite	192
EUUSMB24A	2 klik klak A4 +2 brochure A4 antracite	200

## MONOFACCIALI A4 KLIK-KLAK



### SCHEDA TECNICA MESSAGE A4 ORIZZONTALE MONOFACCIALE

Codice art.	Descrizione	L.P.
EUUSMB25	3 klik klak A4 +1 brochure 1/3 A4 silver	186
EUUSMB26	3 klik klak A4 +1 brochure A5 silver	190
EUUSMB27	3 klik klak A4 +1 brochure A4 silver	194
EUUSMB25AS	3 klik klak A4 +1 brochure 1/3 A4 antracite/silver	186
EUUSMB26AS	3 klik klak A4 +1 brochure A5 antracite/silver	190
EUUSMB27AS	3 klik klak A4 +1 brochure A4 antracite/silver	194
EUUSMB25A	3 klik klak A4 +1 brochure 1/3 A4 antracite	186
EUUSMB26A	3 klik klak A4 +1 brochure A5 antracite	190
EUUSMB27A	3 klik klak A4 +1 brochure A4 antracite	194



### SCHEDA TECNICA MESSAGE A4 ORIZZONTALE MONOFACCIALE

Codice art.	Descrizione	L.P.
EUUSMB28	3 klik klak A4 +2 brochure 1/3 A4 silver	192
EUUSMB29	3 klik klak A4 +2 brochure A5 silver	200
EUUSMB30	3 klik klak A4 +2 brochure A4 silver	210
EUUSMB28AS	3 klik klak A4 +2 brochure 1/3 A4 antracite/silver	192
EUUSMB29AS	3 klik klak A4 +2 brochure A5 antracite/silver	200
EUUSMB30AS	3 klik klak A4 +2 brochure A4 antracite/silver	210
EUUSMB28A	3 klik klak A4 +2 brochure 1/3 A4 antracite	192
EUUSMB29A	3 klik klak A4 +2 brochure A5 antracite	200
EUUSMB30A	3 klik klak A4 +2 brochure A4 antracite	210

## MONOFACCIALI A4 KLIK-KLAK



### SCHEDA TECNICA MESSAGE A4 ORIZZONTALE MONOFACCIALE

Codice art.	Descrizione	L.P.
EUUSMB31	4 klik klak A4 +1 brochure 1/3 A4 silver	196
EUUSMB32	4 klik klak A4 +1 brochure A5 silver	200
EUUSMB33	4 klik klak A4 +1 brochure A4 silver	204
EUUSMB31AS	4 klik klak A4 +1 brochure 1/3 A4 antracite/silver	196
EUUSMB32AS	4 klik klak A4 +1 brochure A5 antracite/ silver	200
EUUSMB33AS	4 klik klak A4 +1 brochure A4 antracite/silver	204
EUUSMB31A	4 klik klak A4 +1 brochure 1/3 A4 antracite	196
EUUSMB32A	4 klik klak A4 +1 brochure A5 antracite	200
EUUSMB33A	4 klik klak A4 +1 brochure A4 antracite	204

## BIFACCIALI A4 KLIK-KLAK



### SCHEDA TECNICA MESSAGE A4 VERTICALE BIFACCIALE

Codice art.	Descrizione	L.P.
EUUSMB34	2+2 klik klak A4 +4 brochure 1/3 A4 silver	216
EUUSMB35	2+2 klik klak A4 +4 brochure A5 silver	232
EUUSMB36	2+2 klik klak A4 +4 brochure A4 silver	252
EUUSMB34AS	2+2 klik klak A4 +4 brochure 1/3 A4 antracite/silver	216
EUUSMB35AS	2+2 klik klak A4 +4 brochure A5 antracite/silver	232
EUUSMB36AS	2+2 klik klak A4 +4 brochure A4 antracite/silver	252
EUUSMB34A	2+2 klik klak A4 +4 brochure 1/3 A4 antracite	216
EUUSMB35A	2+2 klik klak A4 +4 brochure A5 antracite	232
EUUSMB36A	2+2 klik klak A4 +4 brochure A4 antracite	252

## BIFACCIALI A4 KLIK-KLAK



## SCHEDA TECNICA MESSAGE A4 VERTICALE BIFACCIALE

Codice art.	Descrizione	L.P.
EUUSMB37	3+3 klik klak A4 +2 brochure 1/3 A4 silver	220
EUUSMB38	3+3 klik klak A4 +2 brochure A5 silver	228
EUUSMB39	3+3 klik klak A4 +2 brochure A4 silver	238
EUUSMB37AS	3+3 klik klak A4 +2 brochure 1/3 A4 antracite/silver	220
EUUSMB38AS	3+3 klik klak A4 +2 brochure A5 antracite/silver	228
EUUSMB39AS	3+3 klik klak A4 +2 brochure A4 antracite/silver	238
EUUSMB37A	3+3 klik klak A4 +2 brochure 1/3 A4 antracite	220
EUUSMB38A	3+3 klik klak A4 +2 brochure A5 antracite	228
EUUSMB39A	3+3 klik klak A4 +2 brochure A4 antracite	238



## SCHEDA TECNICA MESSAGE A4 ORIZZONTALE BIFACCIALE

Codice art.	Descrizione	L.P.
EUUSMB40	2+2 klik klak A4 +4 brochure 1/3 A4 silver	216
EUUSMB41	2+2 klik klak A4 +4 brochure A5 silver	232
EUUSMB42	2+2 klik klak A4 +4 brochure A4 silver	252
EUUSMB40AS	2+2 klik klak A4 +4 brochure 1/3 A4 antracite/silver	216
EUUSMB41AS	2+2 klik klak A4 +4 brochure A5 antracite/silver	232
EUUSMB42AS	2+2 klik klak A4 +4 brochure A4 antracite/silver	252
EUUSMB40A	2+2 klik klak A4 +4 brochure 1/3 A4 antracite	216
EUUSMB41A	2+2 klik klak A4 +4 brochure A5 antracite	232
EUUSMB42A	2+2 klik klak A4 +4 brochure A4 antracite	252

## BIFACCIALI A4 KLIK-KLAK



## SCHEDA TECNICA MESSAGE A4 ORIZZONTALE BIFACCIALE

Codice art.	Descrizione	L.P.
EUUSMB43	3+3 klik klak A4 +2 brochure 1/3 A4 silver	220
EUUSMB44	3+3 klik klak A4 +2 brochure A5 silver	228
EUUSMB45	3+3 klik klak A4 +2 brochure A4 silver	238
EUUSMB43AS	3+3 klik klak A4 +2 brochure 1/3 A4 antracite/silver	220
EUUSMB44AS	3+3 klik klak A4 +2 brochure A5 antracite/ silver	228
EUUSMB45AS	3+3 klik klak A4 +2 brochure A4 antracite/silver	238
EUUSMB43A	3+3 klik klak A4 +2 brochure 1/3 A4 antracite	220
EUUSMB44A	3+3 klik klak A4 +2 brochure A5 antracite	228
EUUSMB45A	3+3 klik klak A4 +2 brochure A4 antracite	238



## SCHEDA TECNICA MESSAGE A4 ORIZZONTALE BIFACCIALE

Codice art.	Descrizione	L.P.
EUUSMB46	4+4 klik klak A4 +2 brochure 1/3 A4 silver	240
EUUSMB47	4+4 klik klak A4 +2 brochure A5 silver	248
EUUSMB48	4+4 klik klak A4 +2 brochure A4 silver	258
EUUSMB43AS	4+4 klik klak A4 +2 brochure 1/3 A4 antracite/silver	240
EUUSMB44AS	4+4 klik klak A4 +2 brochure A5 antracite/silver	248
EUUSMB45AS	4+4 klik klak A4 +2 brochure A4 antracite/silver	258
EUUSMB46A	4+4 klik klak A4 +2 brochure 1/3 A4 antracite	240
EUUSMB47A	4+4 klik klak A4 +2 brochure A5 antracite	248
EUUSMB48A	4+4 klik klak A4 +2 brochure A4 antracite	258



## MONOFACCIALI A3 KLIK-KLAK

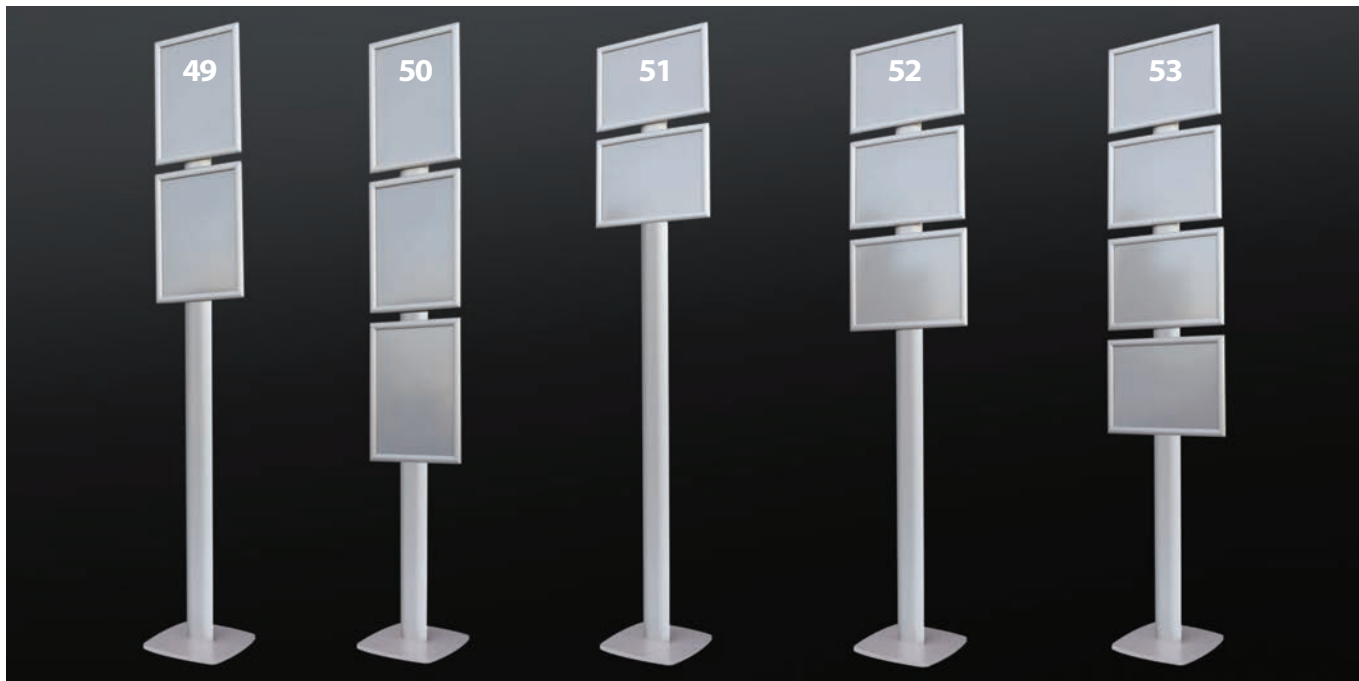

### SCHEMA TECNICA MESSAGE A3 MONOFACCIALE VERTICALE

Codice art.	Descrizione	L.P.
EUUSM49	2 klik klak A3 silver	178
EUUSM50	3 klik klak A3 silver	192
EUUSM49AS	2 klik klak A3 antracite/silver	178
EUUSM50AS	3 klik klak A3 antracite/silver	192
EUUSM49A	2 klik klak A3 antracite	178
EUUSM50A	3 klik klak A3 antracite	192

### SCHEMA TECNICA MESSAGE A3 MONOFACCIALE ORIZZONTALE

Codice art.	Descrizione	L.P.
EUUSM51	2 klik klak A3 silver	178
EUUSM52	3 klik klak A3 silver	192
EUUSM53	4 klik klak A3 silver	205
EUUSM51AS	2 klik klak A3 antracite/silver	178
EUUSM52AS	3 klik klak A3 antracite/silver	192
EUUSM53AS	4 klik klak A3 antracite/silver	205
EUUSM51A	2 klik klak A3 antracite	178
EUUSM52A	3 klik klak A3 antracite	192
EUUSM53A	4 klik klak A3 antracite	205

## BIFACCIALI A3 KLIK-KLAK



### SCHEMA TECNICA MESSAGE A3 BIFACCIALE VERTICALE

Codice art.	Descrizione	L.P.
EUUSM54	2+2 klik klak A3	205
EUUSM55	3+3 klik klak A3	232
EUUSM54AS	2+2 klik klak A3 antracite/silver	205
EUUSM55AS	3+3 klik klak A3 antracite/silver	232
EUUSM54A	2+2 klik klak A3 antracite	205
EUUSM55A	3+3 klik klak A3 antracite	232

### SCHEMA TECNICA MESSAGE A3 BIFACCIALE ORIZZONTALE

Codice art.	Descrizione	L.P.
EUUSM56	2+2 klik klak A3	205
EUUSM57	3+3 klik klak A3	232
EUUSM58	4+4 klik klak A3	260
EUUSM56AS	2+2 klik klak A3 antracite/silver	205
EUUSM57AS	3+3 klik klak A3 antracite/silver	232
EUUSM58AS	4+4 klik klak A3 antracite/silver	260
EUUSM56A	2+2 klik klak A3 antracite	205
EUUSM57A	3+3 klik klak A3 antracite	232
EUUSM58A	4+4 klik klak A3 antracite	260

## MONOFACCIALI A3 KLIK-KLAK



## SCHEDA TECNICA MESSAGE A3 MONOFACCIALE VERTICALE

Codice art.	Descrizione	L.P.
EUUSMB59	2 klik klak A3 +1 brochure 1/3 A4 silver	184
EUUSMB60	2 klik klak A3 +1 brochure A5 silver	188
EUUSMB61	2 klik klak A3 +1 brochure A4 silver	194
EUUSMB59AS	2 klik klak A3 +1 brochure 1/3 A4 antracite/silver	184
EUUSMB60AS	2 klik klak A3 +1 brochure A5 antracite/silver	188
EUUSMB61AS	2 klik klak A3 +1 brochure A4 antracite/silver	194
EUUSMB59A	2 klik klak A3 +1 brochure 1/3 A4 antracite	184
EUUSMB60A	2 klik klak A3 +1 brochure A5 antracite	188
EUUSMB61A	2 klik klak A3 +1 brochure A4 antracite	194



## SCHEDA TECNICA MESSAGE A3 MONOFACCIALE ORIZZONTALE

Codice art.	Descrizione	L.P.
EUUSMB62	2 klik klak A3 +1 brochure 1/3 A4 silver	184
EUUSMB63	2 klik klak A3 +1 brochure A5 silver	188
EUUSMB64	2 klik klak A3 +1 brochure A4 silver	194
EUUSMB62AS	2 klik klak A3 +1 brochure 1/3 A4 antracite/silver	184
EUUSMB63AS	2 klik klak A3 +1 brochure A5 antracite/silver	188
EUUSMB64AS	2 klik klak A3 +1 brochure A4 antracite/silver	194
EUUSMB62A	2 klik klak A3 +1 brochure 1/3 A4 antracite	184
EUUSMB63A	2 klik klak A3 +1 brochure A5 antracite	188
EUUSMB64A	2 klik klak A3 +1 brochure A4 antracite	194

## MONOFACCIALI A3 KLIK-KLAK



## SCHEDA TECNICA MESSAGE A3 MONOFACCIALE ORIZZONTALE

Codice art.	Descrizione	L.P.
EUUSMB65	2 klik klak A3 +2 brochure 1/3 A4 silver	192
EUUSMB66	2 klik klak A3 +2 brochure A5 silver	200
EUUSMB67	2 klik klak A3 +2 brochure A4 silver	210
EUUSMB65AS	2 klik klak A3 +2 brochure 1/3 A4 antracite/silver	192
EUUSMB66AS	2 klik klak A3 +2 brochure A5 antracite silver	200
EUUSMB67AS	2 klik klak A3 +2 brochure A4 antracite/silver	210
EUUSMB65A	2 klik klak A3 +2 brochure 1/3 A4 antracite	192
EUUSMB66A	2 klik klak A3 +2 brochure A5 antracite	200
EUUSMB67A	2 klik klak A3 +2 brochure A4 antracite	210



## SCHEDA TECNICA MESSAGE A3 MONOFACCIALE ORIZZONTALE

Codice art.	Descrizione	L.P.
EUUSMB68	3 klik klak A3 +1 brochure 1/3 A4 silver	198
EUUSMB69	3 klik klak A3 +1 brochure A5 silver	202
EUUSMB70	3 klik klak A3 +1 brochure A4 silver	224
EUUSMB68AS	3 klik klak A3 +1 brochure 1/3 A4 antracite/silver	198
EUUSMB69AS	3 klik klak A3 +1 brochure A5 antracite/silver	202
EUUSMB70AS	3 klik klak A3 +1 brochure A4 antracite/silver	224
EUUSMB68A	3 klik klak A3 +1 brochure 1/3 A4 antracite	198
EUUSMB69A	3 klik klak A3 +1 brochure A5 antracite	202
EUUSMB70A	3 klik klak A3 +1 brochure A4 antracite	224

## BIFACCIALI A3 KLIK-KLAK



### SCHEDA TECNICA MESSAGE A3 BIFACCIALE VERTICALE

Codice art.	Descrizione	L.P.
EUUSMB71	2+2 klik klak A3 + 2 brochure 1/3 A4 silver	220
EUUSMB72	2+2 klik klak A3 + 2 brochure A5 silver	228
EUUSMB73	2+2 klik klak A3 + 2 brochure A4 silver	238
EUUSMB71AS	2+2 klik klak A3 + 2 brochure 1/3 A4 antracite/silver	220
EUUSMB72AS	2+2 klik klak A3 + 2 brochure A5 antracite/silver	228
EUUSMB73AS	2+2 klik klak A3 + 2 brochure A4 antracite/silver	238
EUUSMB71A	2+2 klik klak A3 + 2 brochure 1/3 A4 antracite	220
EUUSMB72A	2+2 klik klak A3 + 2 brochure A5 antracite	228
EUUSMB73A	2+2 klik klak A3 + 2 brochure A4 antracite	238



### SCHEDA TECNICA MESSAGE A3 BIFACCIALE ORIZZONTALE

Codice art.	Descrizione	L.P.
EUUSMB74	2+2 klik klak A3 + 2 brochure 1/3 A4 silver	220
EUUSMB75	2+2 klik klak A3 + 2 brochure A5 silver	228
EUUSMB76	2+2 klik klak A3 + 2 brochure A4 silver	238
EUUSMB74AS	2+2 klik klak A3 + 2 brochure 1/3 A4 antracite/silver	220
EUUSMB75AS	2+2 klik klak A3 + 2 brochure A5 antracite/silver	228
EUUSMB76AS	2+2 klik klak A3 + 2 brochure A4 antracite/silver	238
EUUSMB74A	2+2 klik klak A3 + 2 brochure 1/3 A4 antracite	220
EUUSMB75A	2+2 klik klak A3 + 2 brochure A5 antracite	228
EUUSMB76A	2+2 klik klak A3 + 2 brochure A4 antracite	238

## BIFACCIALI A3 KLIK-KLAK



### SCHEDA TECNICA MESSAGE A3 BIFACCIALE ORIZZONTALE

Codice art.	Descrizione	L.P.
EUUSMB77	2+2 klik klak A3 + 4 brochure 1/3 A4 silver	234
EUUSMB78	2+2 klik klak A3 + 4 brochure A5 silver	250
EUUSMB79	2+2 klik klak A3 + 4 brochure A4 silver	270
EUUSMB77AS	2+2 klik klak A3 + 4 brochure 1/3 A4 antracite/silver	234
EUUSMB78AS	2+2 klik klak A3 + 4 brochure A5 antracite/silver	250
EUUSMB79AS	2+2 klik klak A3 + 4 brochure A4 antracite/silver	270
EUUSMB77A	2+2 klik klak A3 + 4 brochure 1/3 A4 antracite	234
EUUSMB78A	2+2 klik klak A3 + 4 brochure A5 antracite	250
EUUSMB79A	2+2 klik klak A3 + 4 brochure A4 antracite	270



### SCHEDA TECNICA MESSAGE A3 BIFACCIALE ORIZZONTALE

Codice art.	Descrizione	L.P.
EUUSMB80	3+3 klik klak A3 + 2 brochure 1/3 A4 silver	246
EUUSMB81	3+3 klik klak A3 + 2 brochure A5 silver	254
EUUSMB82	3+3 klik klak A3 + 2 brochure A4 silver	264
EUUSMB80AS	3+3 klik klak A3 + 2 brochure 1/3 A4 antracite/silver	246
EUUSMB81AS	3+3 klik klak A3 + 2 brochure A5 antracite/silver	254
EUUSMB82AS	3+3 klik klak A3 + 2 brochure A4 antracite/silver	264
EUUSMB80A	3+3 klik klak A3 + 2 brochure 1/3 A4 antracite	246
EUUSMB81A	3+3 klik klak A3 + 2 brochure A5 antracite	254
EUUSMB82A	3+3 klik klak A3 + 2 brochure A4 antracite	264

## MONOFACCIALI B2 KLIK-KLAK



## SCHEMA TECNICA MESSAGE B2 CM. 50x70 MONOFACCIALE

Codice art.	Descrizione	L.P.
<b>EUUSM83</b>	1 klik klak B2 cm 50x70 verticale silver	200
<b>EUUSM84</b>	1 klik klak B2 cm 50x70 orizzontale silver	200
<b>EUUSM83AS</b>	1 klik klak B2 cm 50x70 verticale antracite/silver	200
<b>EUUSM84AS</b>	1 klik klak B2 cm 50x70 orizzontale antracite/silver	200
<b>EUUSM83A</b>	1 klik klak B2 cm 50x70 verticale antracite	200
<b>EUUSM84A</b>	1 klik klak B2 cm 50x70 orizzontale antracite	200

## SCHEMA TECNICA MESSAGE B2 CM. 50x70 MONOFACCIALE

Codice art.	Descrizione	L.P.
<b>EUUSM85</b>	2 klik klak B2 cm 70x50 verticale silver	235
<b>EUUSM86</b>	2 klik klak B2 cm 70x50 orizzontale silver	235
<b>EUUSM85AS</b>	2 klik klak B2 cm 70x50 verticale antracite/silver	235
<b>EUUSM86AS</b>	2 klik klak B2 cm 70x50 orizzontale antracite/silver	235
<b>EUUSM85A</b>	2 klik klak B2 cm 70x50 verticale antracite	235
<b>EUUSM86A</b>	2 klik klak B2 cm 70x50 orizzontale antracite	235

## BIFACCIALI B2 KLIK-KLAK



## SCHEMA TECNICA MESSAGE B2 CM. 50x70 BIFACCIALE

Codice art.	Descrizione	L.P.
<b>EUUSM87</b>	1+1 klik klak B2 cm 50x70 verticale silver	235
<b>EUUSM88</b>	1+1 klik klak B2 cm 50x70 orizzontale silver	235
<b>EUUSM87AS</b>	1+1 klik klak B2 cm 50x70 verticale antracite/silver	235
<b>EUUSM88AS</b>	1+1 klik klak B2 cm 50x70 orizzontale antracite/silver	235
<b>EUUSM87A</b>	1+1 klik klak B2 cm 50x70 verticale antracite	235
<b>EUUSM88A</b>	1+1 klik klak B2 cm 50x70 orizzontale antracite	235

## SCHEMA TECNICA MESSAGE B2 CM. 50x70 BIFACCIALE

Codice art.	Descrizione	L.P.
<b>EUUSM89</b>	2+2 klik klak B2 cm 70x50 verticale silver	306
<b>EUUSM90</b>	2+2 klik klak B2 cm 70x50 orizzontale silver	306
<b>EUUSM89AS</b>	2+2 klik klak B2 cm 70x50 verticale antracite/silver	306
<b>EUUSM90AS</b>	2+2 klik klak B2 cm 70x50 orizzontale antracite/silver	306
<b>EUUSM89A</b>	2+2 klik klak B2 cm 70x50 verticale antracite	306
<b>EUUSM90A</b>	2+2 klik klak B2 cm 70x50 orizzontale antracite	306

## MONOFACCIALI B2 KLIK-KLAK



### SCHEMA TECNICA MESSAGE B2 cm 50x70 MONOFACCIALE VERTICALE

Codice art.	Descrizione	L.P.
EUUSMB91	1 klik klak B2 cm 50x70 +1 broch. 1/3 A4 silver	208
EUUSMB92	1 klik klak B2 cm 50x70 +1 broch. A5 silver	212
EUUSMB93	1 klik klak B2 cm 50x70 +1 broch. A4 silver	216
EUUSMB91AS	1 klik klak B2 cm 50x70 +1 broch. 1/3 A4 antracite/silver	208
EUUSMB92AS	1 klik klak B2 cm 50x70 +1 broch. A5 antracite/silver	212
EUUSMB93AS	1 klik klak B2 cm 50x70 +1 broch. A4 antracite/silver	216
EUUSMB91A	1 klik klak B2 cm 50x70 +1 broch. 1/3 A4 antracite	208
EUUSMB92A	1 klik klak B2 cm 50x70 +1 broch. A5 antracite	212
EUUSMB93A	1 klik klak B2 cm 50x70 +1 broch. A4 antracite	216



### SCHEMA TECNICA MESSAGE B2 cm 70x50 MONOFACCIALE ORIZZONTALE

Codice art.	Descrizione	L.P.
EUUSMB94	1 klik klak B2 cm 70x50 +1 broch. 1/3 A4 silver	208
EUUSMB95	1 klik klak B2 cm 70x50 +1 broch. A5 silver	212
EUUSMB96	1 klik klak B2 cm 70x50 +1 broch. A4 silver	216
EUUSMB94AS	1 klik klak B2 cm 70x50 +1 broch. 1/3 A4 antracite/silver	208
EUUSMB95AS	1 klik klak B2 cm 70x50 +1 broch. A5 antracite/silver	212
EUUSMB96AS	1 klik klak B2 cm 70x50 +1 broch. A4 antracite/silver	216
EUUSMB94A	1 klik klak B2 cm 70x50 +1 broch. 1/3 A4 antracite	208
EUUSMB95A	1 klik klak B2 cm 70x50 +1 broch. A5 antracite	212
EUUSMB96A	1 klik klak B2 cm 70x50 +1 broch. A4 antracite	216

## MONOFACCIALI B2 KLIK-KLAK



### SCHEMA TECNICA MESSAGE B2 cm 50x70 MONOFACCIALE VERTICALE

Codice art.	Descrizione	L.P.
EUUSMB97	1 klik klak B2 cm 50x70 +2 broch. 1/3 A4 silver	214
EUUSMB98	1 klik klak B2 cm 50x70 +2 broch. A5 silver	222
EUUSMB99	1 klik klak B2 cm 50x70 +2 broch. A4 silver	232
EUUSMB97AS	1 klik klak B2 cm 50x70 +2 broch. 1/3 A4 antracite/silver	214
EUUSMB98AS	1 klik klak B2 cm 50x70 +2 broch. A5 antracite/silver	222
EUUSMB99AS	1 klik klak B2 cm 50x70 +2 broch. A4 antracite/silver	232
EUUSMB97A	1 klik klak B2 cm 50x70 +2 broch. 1/3 A4 antracite	214
EUUSMB98A	1 klik klak B2 cm 50x70 +2 broch. A5 antracite	222
EUUSMB99A	1 klik klak B2 cm 50x70 +2 broch. A4 antracite	232



### SCHEMA TECNICA MESSAGE B2 cm 70x50 MONOFACCIALE ORIZZONTALE

Codice art.	Descrizione	L.P.
EUUSMB100	1 klik klak B2 cm 70x50 2 broch. 1/3 A4 silver	214
EUUSMB101	1 klik klak B2 cm 70x50 +2 broch. A5 silver	222
EUUSMB102	1 klik klak B2 cm 70x50 +2 broch. A4 silver	232
EUUSMB100AS	1 klik klak B2 cm 70x50 +2 broch. 1/3 A4 antracite/silver	214
EUUSMB101AS	1 klik klak B2 cm 70x50 +2 broch. A5 antracite/silver	222
EUUSMB102AS	1 klik klak B2 cm 70x50 +2 broch. A4 antracite/silver	232
EUUSMB100A	1 klik klak B2 cm 70x50 +2 broch. 1/3 A4 antracite	214
EUUSMB101A	1 klik klak B2 cm 70x50 +2 broch. A5 antracite	222
EUUSMB102A	1 klik klak B2 cm 70x50 +2 broch. A4 antracite	232

## BIFACCIALI B2 KLIK-KLAK



## SCHEMA TECNICA MESSAGE B2 cm 50x70 BIFACCIALE VERTICALE

Codice art.	Descrizione	L.P.
EUUSMB103	1+1 klik klak B2 cm 50x70 +2 broch. 1/3 A4 silver	250
EUUSMB104	1+1 klik klak B2 cm 50x70 +2 broch. A5 silver	258
EUUSMB105	1+1 klik klak B2 cm 50x70 +2 broch. A4 silver	268
EUUSMB103AS	1+1 klik klak B2 cm 50x70 +2 broch. 1/3 A4 antracite/silver	250
EUUSMB104AS	1+1 klik klak B2 cm 50x70 +2 broch. A5 antracite/silver	258
EUUSMB105AS	1+1 klik klak B2 cm 50x70 +2 broch. A4 antracite/silver	268
EUUSMB103A	1+1 klik klak B2 cm 50x70 +2 broch. 1/3 A4 antracite	250
EUUSMB104A	1+1 klik klak B2 cm 50x70 +2 broch. A5 antracite	258
EUUSMB105A	1+1 klik klak B2 cm 50x70 +2 broch. A4 antracite	268



## SCHEMA TECNICA MESSAGE B2 cm 70x50 BIFACCIALE ORIZZONTALE

Codice art.	Descrizione	L.P.
EUUSMB106	1+1 klik klak B2 cm 70x50 +2 broch. 1/3 A4 silver	250
EUUSMB107	1+1 klik klak B2 cm 70x50 +2 broch. A5 silver	258
EUUSMB108	1+1 klik klak B2 cm 70x50 +2 broch. A4 silver	268
EUUSMB106AS	1+1 klik klak B2 cm 70x50 +2 broch. 1/3 A4 antracite/silver	250
EUUSMB107AS	1+1 klik klak B2 cm 70x50 +2 broch. A5 antracite/silver	258
EUUSMB108AS	1+1 klik klak B2 cm 70x50 +2 broch. A4 antracite/silver	268
EUUSMB106A	1+1 klik klak B2 cm 70x50 +2 broch. 1/3 A4 antracite	250
EUUSMB107A	1+1 klik klak B2 cm 70x50 +2 broch. A5 antracite	258
EUUSMB108A	1+1 klik klak B2 cm 70x50 +2 broch. A4 antracite	268

## BIFACCIALI B2 KLIK-KLAK



## SCHEMA TECNICA MESSAGE B2 cm 50x70 BIFACCIALE VERTICALE

Codice art.	Descrizione	L.P.
EUUSMB109	1+1 klik klak B2 cm 50x70 +4 broch. 1/3 A4 silver	264
EUUSMB110	1+1 klik klak B2 cm 50x70 +4 broch. A5 silver	280
EUUSMB111	1+1 klik klak B2 cm 50x70 +4 broch. A4 silver	300
EUUSMB109AS	1+1 klik klak B2 cm 50x70 +4 broch. 1/3 A4 antracite/silver	264
EUUSMB110AS	1+1 klik klak B2 cm 50x70 +4 broch. A5 antracite/silver	280
EUUSMB111AS	1+1 klik klak B2 cm 50x70 +4 broch. A4 antracite/silver	300
EUUSMB109A	1+1 klik klak B2 cm 50x70 +4 broch. 1/3 A4 antracite	264
EUUSMB110A	1+1 klik klak B2 cm 50x70 +4 broch. A5 antracite	280
EUUSMB111A	1+1 klik klak B2 cm 50x70 +4 broch. A4 antracite	300



## SCHEMA TECNICA MESSAGE B2 cm 70x50 BIFACCIALE ORIZZONTALE

Codice art.	Descrizione	L.P.
EUUSMB112	1+1 klik klak B2 cm 70x50 +4 broch. 1/3 A4 silver	264
EUUSMB113	1+1 klik klak B2 cm 70x50 +4 broch. A5 silver	280
EUUSMB114	1+1 klik klak B2 cm 70x50 +4 broch. A4 silver	300
EUUSMB112AS	1+1 klik klak B2 cm 70x50 +4 broch. 1/3 A4 antracite/silver	264
EUUSMB113AS	1+1 klik klak B2 cm 70x50 +4 broch. A5 antracite/silver	280
EUUSMB114AS	1+1 klik klak B2 cm 70x50 +4 broch. A4 antracite/silver	300
EUUSMB112A	1+1 klik klak B2 cm 70x50 +4 broch. 1/3 A4 antracite	264
EUUSMB113A	1+1 klik klak B2 cm 70x50 +4 broch. A5 antracite	280
EUUSMB114A	1+1 klik klak B2 cm 70x50 +4 broch. A4 antracite	300

## MONOFACCIALE B1 KLIK-KLAK



### SCHEDA TECNICA MESSAGE B1 CM. 70x100 MONOFACCIALE VERTICALE

Codice art.	Descrizione	L.P.
<b>EUUSM115</b>	1 klik klak B1 cm 70x100 verticale silver	220
<b>EUUSM115AS</b>	1 klik klak B1 cm 70x100 verticale antracite/silver	220
<b>EUUSM115A</b>	1 klik klak B1 cm 70x100 verticale antracite	220

### SCHEDA TECNICA MESSAGE B1 CM. 70x100 MONOFACCIALE VERTICALE

Codice art.	Descrizione	L.P.
<b>EUUSMB116</b>	1 klik klak B1 cm 70x100 +1 broch. 1/3 A4 silver	228
<b>EUUSMB117</b>	1 klik klak B1 cm 70x100 +1 broch. A5 silver	232
<b>EUUSMB118</b>	1 klik klak B1 cm 70x100 +1 broch. A4 silver	252
<b>EUUSMB116AS</b>	1 klik klak B1 cm 70x100 +1 broch. 1/3 A4 antracite/silver	228
<b>EUUSMB117AS</b>	1 klik klak B1 cm 70x100 +1 broch. A5 antracite/silver	232
<b>EUUSMB118AS</b>	1 klik klak B1 cm 70x100 +1 broch. A4 antracite/silver	252
<b>EUUSMB116A</b>	1 klik klak B1 cm 70x100 +1 broch. 1/3 A4 antracite	228
<b>EUUSMB117A</b>	1 klik klak B1 cm 70x100 +1 broch. A5 antracite	232
<b>EUUSMB118A</b>	1 klik klak B1 cm 70x100 +1 broch. A4 antracite	252

## BIFACCIALI B1 KLIK-KLAK



### SCHEDA TECNICA MESSAGE B1 CM. 70x100 BIFACCIALE VERTICALE

Codice art.	Descrizione	L.P.
<b>EUUSM119</b>	1+1 klik klak B1 cm 70x100 verticale silver	276
<b>EUUSM119AS</b>	1+1 klik klak B1 cm 70x100 verticale antracite/silver	276
<b>EUUSM119A</b>	1+1 klik klak B1 cm 70x100 verticale antracite	276

### SCHEDA TECNICA MESSAGE B1 CM. 70x100 BIFACCIALE VERTICALE

Codice art.	Descrizione	L.P.
<b>EUUSMB120</b>	1+1 klik klak B1 cm 70x100 +2 broch. 1/3 A4 silver	290
<b>EUUSMB121</b>	1+1 klik klak B1 cm 70x100 +2 broch. A5 silver	298
<b>EUUSMB122</b>	1+1 klik klak B1 cm 70x100 +2 broch. A4 silver	308
<b>EUUSMB120AS</b>	1+1 klik klak B1 cm 70x100 +2 broch. 1/3 A4 antracite/silver	290
<b>EUUSMB121AS</b>	1+1 klik klak B1 cm 70x100 +2 broch. A5 antracite/silver	298
<b>EUUSMB122AS</b>	1+1 klik klak B1 cm 70x100 +2 broch. A4 antracite/silver	308
<b>EUUSMB120A</b>	1+1 klik klak B1 cm 70x100 +2 broch. 1/3 A4 antracite	290
<b>EUUSMB121A</b>	1+1 klik klak B1 cm 70x100 +2 broch. A5 antracite	298
<b>EUUSMB122A</b>	1+1 klik klak B1 cm 70x100 +2 broch. A4 antracite	308

# US STYLE KLIK-KLAK

Struttura autoportante monofacciale o bifacciale in alluminio silver, oppure in antracite, per l'esposizione di poster con cornici klik-klak nei formati cm. 50x70, cm. 70x100 e cm. 100x140. Optional le mensole porta-brochure in Perspex fumè.

Monofacial or bifacial free-standing structure in silver or anthracite grey aluminum for poster exhibition, with klik-klak frames in size of 50x70 cm., 70x100 cm. and 100x140 cm. Optional the pocket brochure shelves in smoky grey Perspex

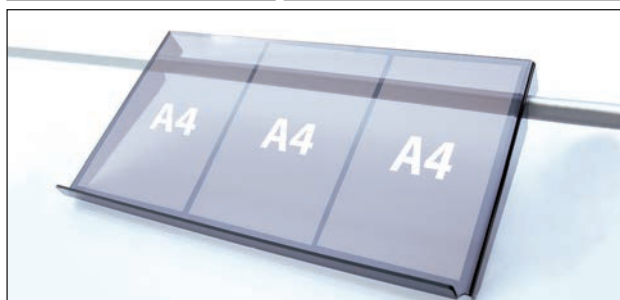
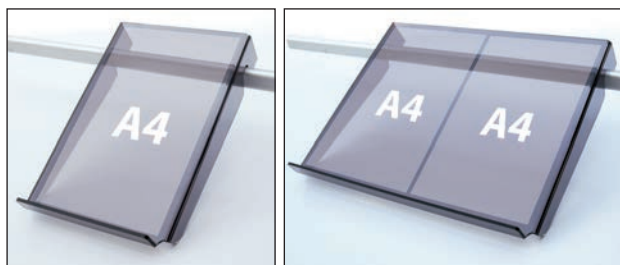

## SCHEDA TECNICA

Codice art.	Descrizione	L.P.
EUUSSTK57MO	Style silver monofacciale cm. 50x70	362
EUUSSTK57BI	Style silver bifacciale cm. 50x70	396
EUUSSTK710MO	Style silver monofacciale cm. 70x100	396
EUUSSTK710BI	Style silver bifacciale cm. 70x100	451
EUUSSTK1014MO	Style silver monofacciale cm. 100x140	454
EUUSSTK1014BI	Style silver bifacciale cm. 100x140	546
EUUSSTK57MOA	Style antracite monofacciale cm. 50x70	362
EUUSSTK57BIA	Style antracite bifacciale cm. 50x70	396
EUUSSTK710MOA	Style antracite monofacciale cm. 70x100	396
EUUSSTK710BIA	Style antracite bifacciale cm. 70x100	451
EUUSSTK1014MOA	Style antracite monofacciale cm. 100x140	454
EUUSSTK1014BIA	Style antracite bifacciale cm. 100x140	546
EUUSRIP1A4	Mensola Perspex fumè per 1 f.to A4	50
EUUSRIP2A4	Mensola Perspex fumè per 2 f.to A4	65
EUUSRIP3A4	Mensola Perspex fumè per 3 f.to A4	82



# US ACCADISPLAY

Struttura autoportante in alluminio silver per l'esposizione di poster bifacciali in cornici klik-klak nei formati cm. 50x70, cm. 70x100 .

*Free-standing structure, realized in silver or anthracite grey aluminum for bifacial poster exhibition in klik-klak frames size 50x70 cm., cm. 70x100.*



## SCHEMA TECNICA

Codice art.	Descrizione	Grafica cm.	L.P.
EUUSHD57	Accadisplay bifacciale cm.50x70	50x70	334
EUUSHD710	Accadisplay bifacciale cm.70x100	70x100	374



# US SWING ANTIVENTO

Struttura autoportante antivento in alluminio silver, per l'esposizione di poster bifacciali in cornici klik-klak nei formati cm. 50x70, cm. 70x100, cm. 100x140; utilizzato in vari contesti esterni (parcheggi, stazioni di servizio, aree di sosta, ecc.).

*Monofacial or bifacial free-standing windproof structure in silver aluminum for bifacial poster exhibition, with klik-klak frames in size of 50x70 cm., 70x100 cm. and 100x140 cm. to be utilized in various external context (parking, service stations, parking areas etc.)*

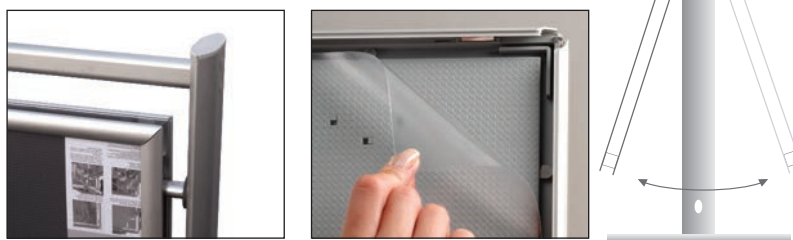

## SCHEMA TECNICA

Codice art.	Descrizione	Grafica cm.	L.P.
EUUSSW57	Univers Swing bifacciale cm 50x70	50X70	280
EUUSSW710	Univers Swing bifacciale cm 70x100	70X100	404
EUUSSW1014	Univers Swing bifacciale cm 100x140	100X140	616



Pratica struttura autoportante in alluminio estruso anodizzato adatta ad esporre un grande numero di messaggi pubblicitari tramite tasche trasparenti nei formati A4 sia orizzontali che verticali o pannelli grafici, fissati a tubolari orizzontali di sezione ovale.

Practical free-standing structure in extruded anodized aluminum to exhibit a great number of advertisement communications through transparent pockets in A4 sizes both horizontal and vertical or graphic panel fixed by means of horizontal tubulars of oval section.

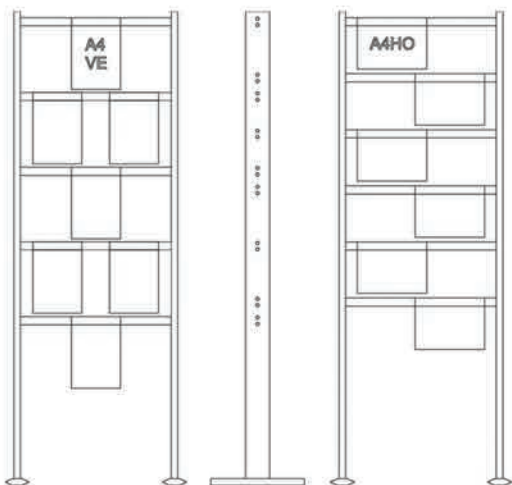

## COMPOSIZIONE STRUTTURE

### A4 verticale

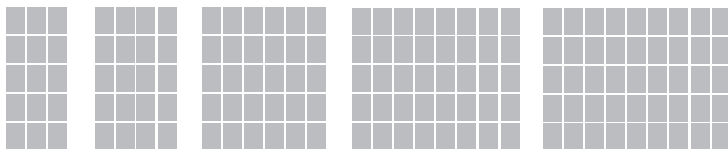

USEX15A4VE

USEX20A4VE

USEX30A4VE

USEX40A4VE

USEX45A4VE

### A4 orizzontale



USEX12A4HO

USEX18A4HO

USEX24A4HO

USEX30A4HO

USEX36A4HO



## SCHEMA TECNICA

Codice art.	Num. tasche	F.to tasche	Dim. struttura cm.	L.P.
EUUSEX15A4VE	15	A4 verticale	72x200	526
EUUSEX20A4VE	20	A4 verticale	102x200	612
EUUSEX30A4VE	30	A4 verticale	136x200	736
EUUSEX40A4VE	40	A4 verticale	182x200	922
EUUSEX45A4VE	45	A4 verticale	206x200	921
EUUSEX12A4HO	12	A4 orizzontale	72x200	500
EUUSEX18A4HO	18	A4 orizzontale	102x200	602
EUUSEX24A4HO	24	A4 orizzontale	136x200	716
EUUSEX30A4HO	30	A4 orizzontale	182x200	830
EUUSEX36A4HO	36	A4 orizzontale	206x200	902

# US GLOBAL

Struttura autoportante per l'esposizione di brochure e cataloghi in formato A4, realizzata in alluminio silver; è disponibile con un minimo di 6 fino ad un massimo di 48 contenitori A4. Altezza cm. 170, larghezze variabili da cm. 50, 75, 100, 125, 150, 175, 200.

Free-standing structure to brochure and catalogues exhibition in A4 sizes, realized in silver aluminum; it is available with a minimum of six until a maximum of 48 A4 containers. Heights cm. 170; variable width from cm. 50, 75, 100, 125, 150, 175, 200.



## SCHEMA TECNICA

Codice art.	Descrizione	Dimensioni cm.	L.P.
EUUSGL12A4	12 tasche porta-brochure A4	50x170	350
EUUSGL18A4	18 tasche porta-brochure A4	75x170	450
EUUSGL24A4	24 tasche porta-brochure A4	100x170	550
EUUSGL30A4	30 tasche porta-brochure A4	125x170	650
EUUSGL36A4	36 tasche porta-brochure A4	150x170	750
EUUSGL42A4	42 tasche porta-brochure A4	175x170	850
EUUSGL48A4	48 tasche porta-brochure A4	200x170	950

## COMPOSIZIONE STRUTTURE

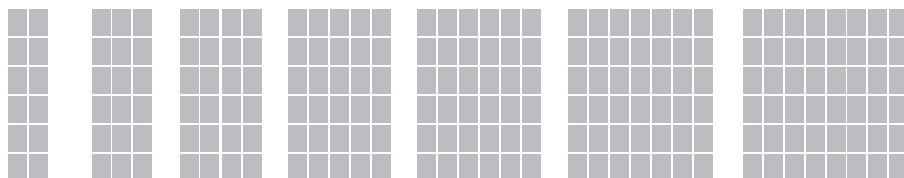

USGL12A4

USGL18A4

USGL24A4

USGL30A4

USGL36A4

USGL42A4

USGL48A4

# US STANDING

Struttura autoportante realizzata in alluminio anodizzato silver. Questo espositore consente di esporre più messaggi grazie a delle tasche realizzate in Perspex trasparente, sorrette da un sistema di cavi in acciaio tensionati. Le tasche, in formato A4, possono essere doppie o triple e la composizione, all'interno della struttura, potrà essere a piacimento. Di seguito riportiamo alcune dimensioni standard, a richiesta, è possibile realizzare altre dimensioni e composizioni.

*Self-standing structure realized with silver anodized aluminum. This exhibitor allows to show several messages thanks to the clear Perspex pockets, hold through a system of steel stretched wires. Pockets, size A4, can be double or triple and the composition inside the structure can be to pleasure. In the following pictures there are some standard sizes and, upon request, it is possible to realize other sizes and compositions.*



## COMPOSIZIONE STRUTTURE

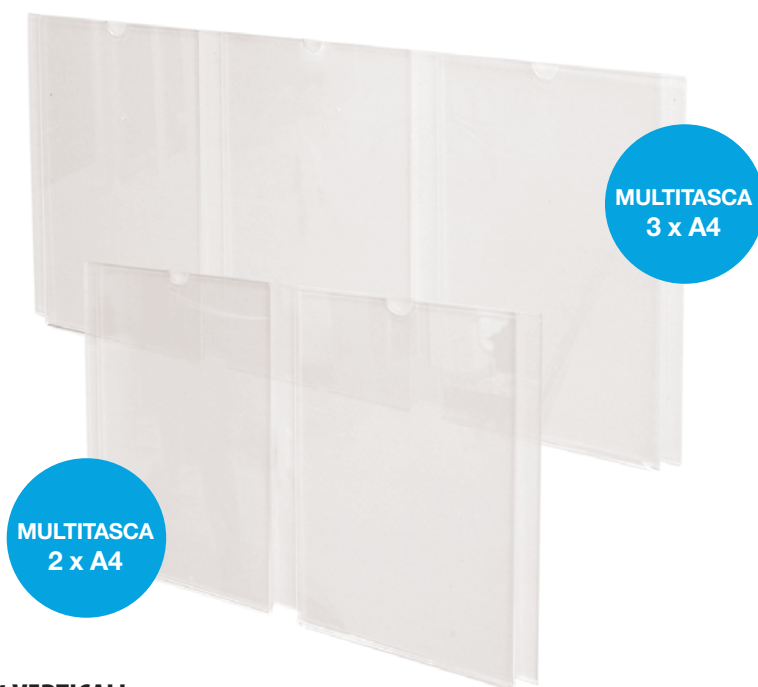
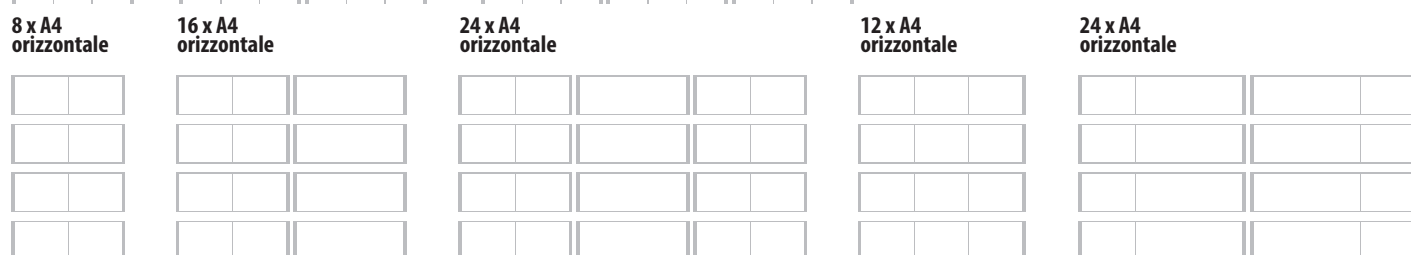
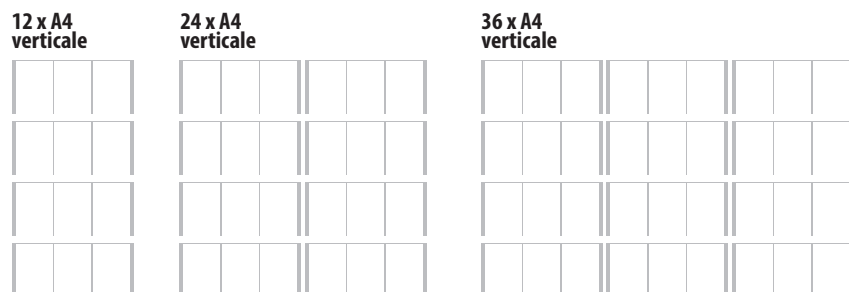
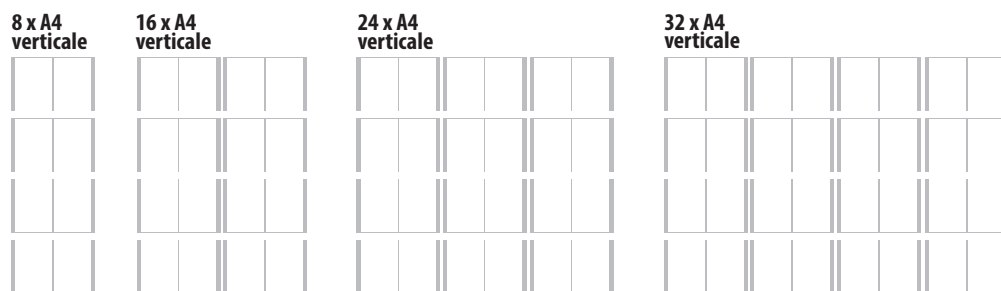

### SCHEMA TECNICO A4 VERTICALI

Codice art.	Dim. struttura cm.	F.to tasche	N. pannelli	Tip. Tasche	N. tasche A4	L.P.
EUUSSTA42A4V	60x200	A4 verticale	4	2 x A4	8	336
EUUSSTA82A4V	113x200	A4 verticale	8	2 x A4	16	550
EUUSSTA122A4V	166x200	A4 verticale	12	2 x A4	24	744
EUUSSTA162A4V	219x200	A4 verticale	16	2 x A4	32	862
EUUSSTA43A4V	83x200	A4 verticale	4	3 x A4	12	424
EUUSSTA83A4V	159x200	A4 verticale	8	3 x A4	24	686
EUUSSTA123A4V	235x200	A4 verticale	12	3 x A4	36	948

### SCHEMA TECNICO A4 ORIZZONTALI

Codice art.	Dim. struttura cm.	F.to tasche	N. pannelli	Tip. Tasche	N. tasche A4	L.P.
EUUSSTA42A4O	78x200	A4 orizzontale	4	2 x A4	8	350
EUUSSTA82A4O	149x200	A4 orizzontale	8	2 x A4	16	520
EUUSSTA122A4O	220x200	A4 orizzontale	12	2 x A4	24	678
EUUSSTA43A4O	110x200	A4 orizzontale	4	3 x A4	12	406
EUUSSTA83A4O	213x200	A4 orizzontale	8	3 x A4	24	620

### KIT ARGENTO SATINATO



# US BASE

Struttura composta da base in PVC-HD e palo ellittico in alluminio silver con biadesivo per il fissaggio di pannelli, sagome, ecc. . Disponibile in diversi formati su richiesta.

Structure consisting of a base in PVC - HD and pole elliptical aluminum silver with double-sided tape for attaching of panels , templates , etc. . Available in different formats on request.

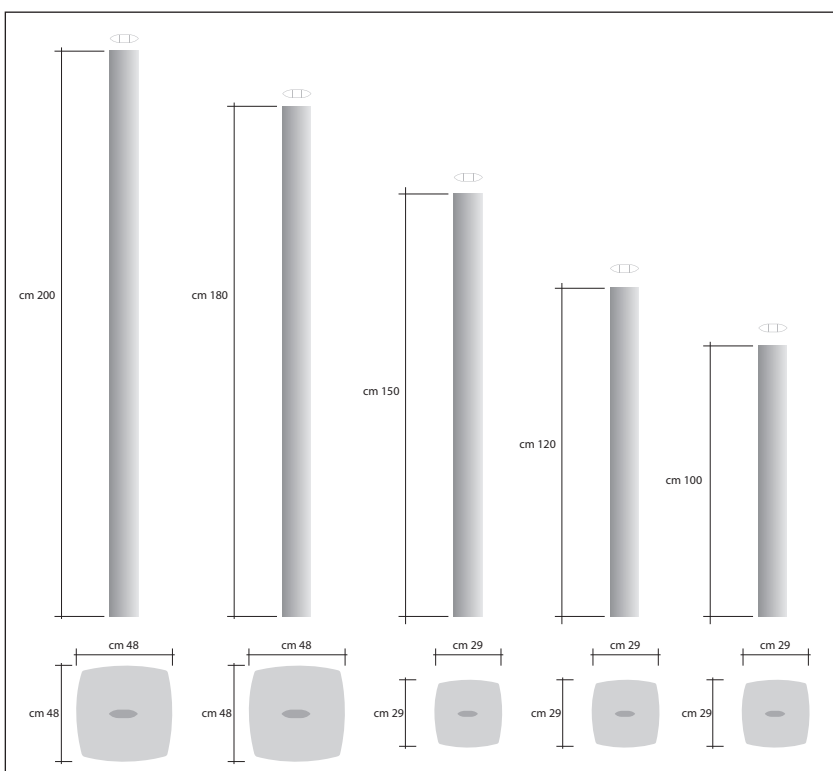
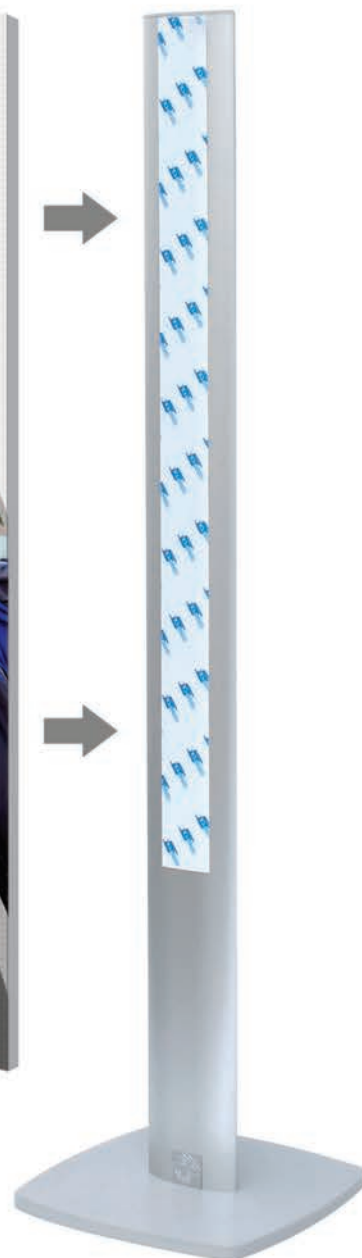

## SCHEMA TECNICA

Codice art.	Altezza cm.	Base cm.	L.P.
EUUSBASE100	100	29x29	95
EUUSBASE120	120	29x29	102
EUUSBASE150	150	29x29	125
EUUSBASE180	180	48x48	190
EUUSBASE200	200	48x48	195

# US BASE REGOLABILE

Struttura autoportante monofacciale in alluminio silver e base in PVC-HD grigio; i supporti sono regolabili su qualsiasi altezza, e possono alloggiare pannelli leggeri sandwich di dimensioni consigliate max cm. 100 x 200, fino ad uno spessore massimo di mm. 15.

*Self-supporting single sided aluminum base silver and gray PVC-HD; the struts are adjustable to any height, and can lodge light sandwich panels recommended size max cm. 100 x 200, up to mm. 15 of maximum thickness.*



## SCHEDA TECNICA

Codice art.	Pannello cm.	Base cm.	L.P.
EUUSBASEREG	80/100x200	29x29	180



# US ELLE

Struttura autoportante monofacciale in alluminio silver e base in PVC-HD grigio; l'asta inferiore è facilmente regolabile su qualsiasi misura, fino ad ospitare un banner di altezza massima mt. 2 e larghezza mt. 1.

*Self-supporting single-sided aluminum base silver and grey PVC - HD ; the lower rod is easily adjustable to any size , up to host a banner of maximum height mt. 2 and 1 mt. wide.*

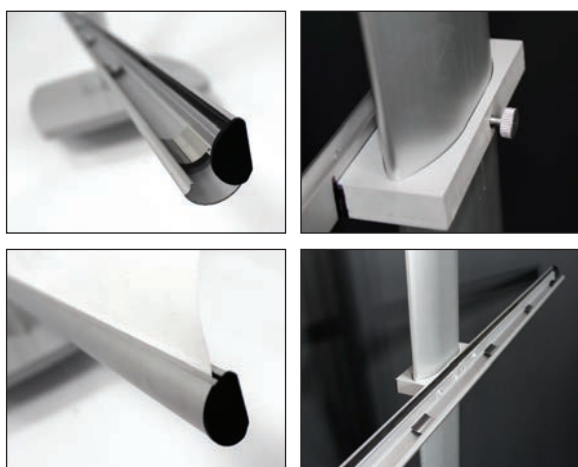

## SCHEDA TECNICA

Codice art.	Banner cm.	Base cm.	L.P.
EUUSELLE502	50x200	29x29	172
EUUSELLE602	60x200	29x29	176
EUUSELLE702	70x200	29x29	178
EUUSELLE852	85x200	29x29	180
EUUSELLE102	100x200	29x29	184



# US UNIVERSAL BROCHURE

Struttura autoportante in alluminio anodizzato silver o antracite e base in PVC-HD, disponibile sia monofacciale che bifacciale; altezza cm. 170, con serie di tasche porta-brochure formato A5 e A4.

*Self-supporting anodized aluminum silver or anthracite structure and PVC base - HD, available in both single-sided and double-sided; height cm. 170, with several pockets - brochure A5 and A4.*



PORTABROCHURE FTO A5

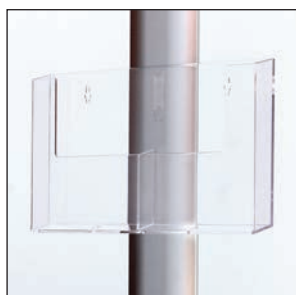

PORTABROCHURE FTO A5X2

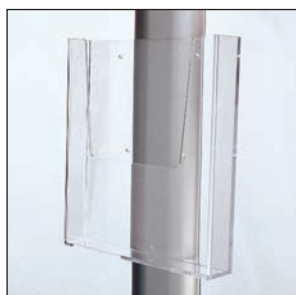

PORTABROCHURE FTO A4

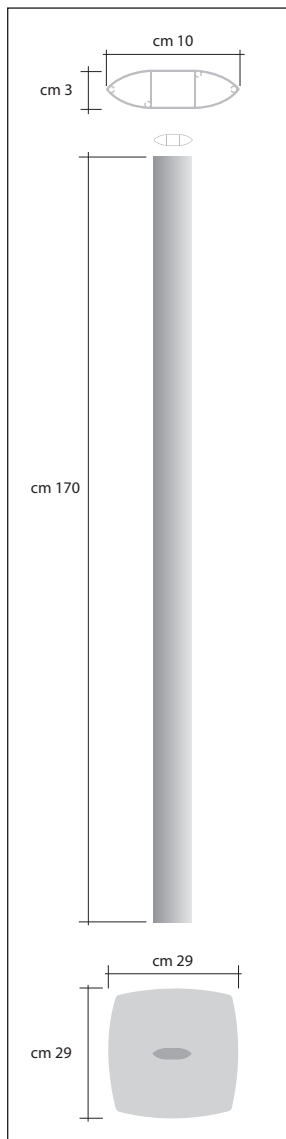



## MONOFACCIALI

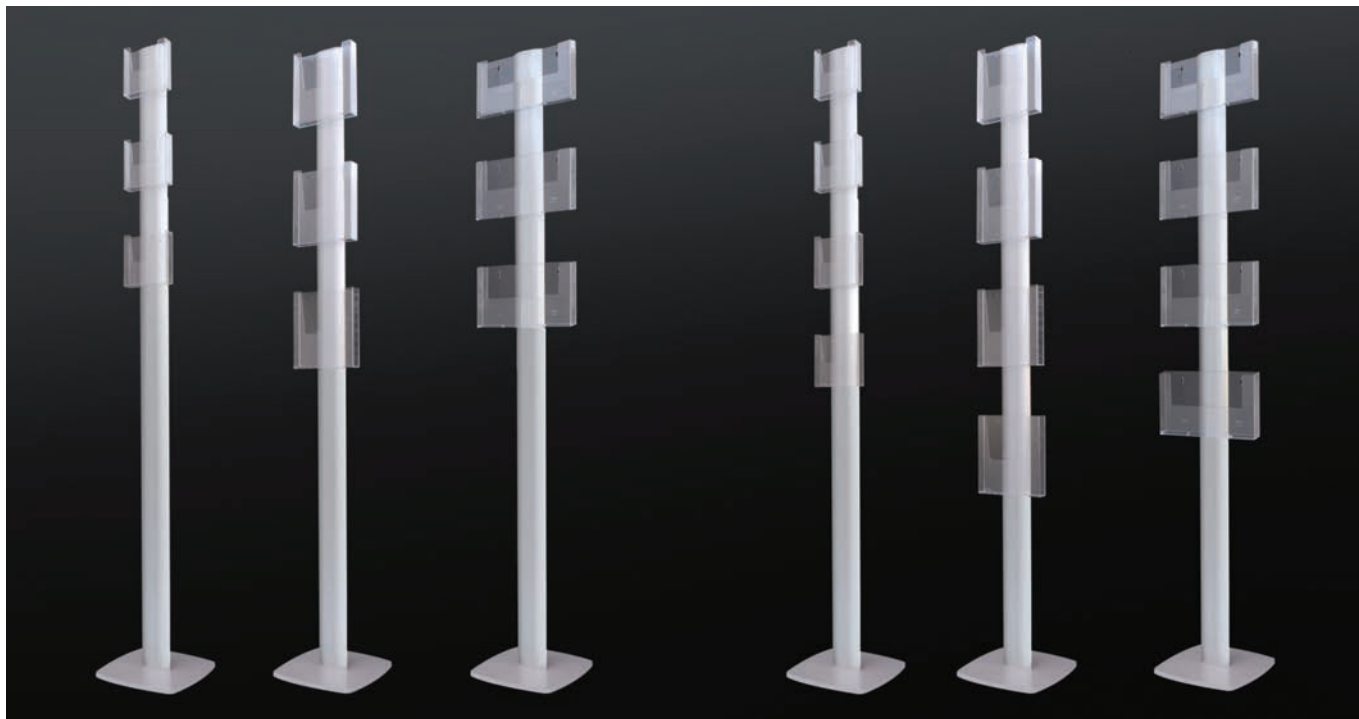

### SCHEDA TECNICA UNIVERSAL BROCHURE 3 TASCHE MONOFACCIALE

Codice art.	Descrizione	L.P.
EUUSBR123	3 tasche f.to A5 silver	184
EUUSBR124	3 tasche f.to A4 silver	198
EUUSBR125	3 tasche f.to 2xA5 silver	204
EUUSBR123A	3 tasche f.to A5 antracite	184
EUUSBR124A	3 tasche f.to A4 antracite	198
EUUSBR125A	3 tasche f.to 2xA5 antracite	204

### SCHEDA TECNICA UNIVERSAL BROCHURE 4 TASCHE MONOFACCIALE

Codice art.	Descrizione	L.P.
EUUSBR126	4 tasche f.to A5 silver	194
EUUSBR127	4 tasche f.to A4 silver	214
EUUSBR128	4 tasche f.to 2xA5 silver	222
EUUSBR126A	4 tasche f.to A5 antracite	194
EUUSBR127A	4 tasche f.to A4 antracite	214
EUUSBR128A	4 tasche f.to 2xA5 antracite	222

## BIFACCIALI

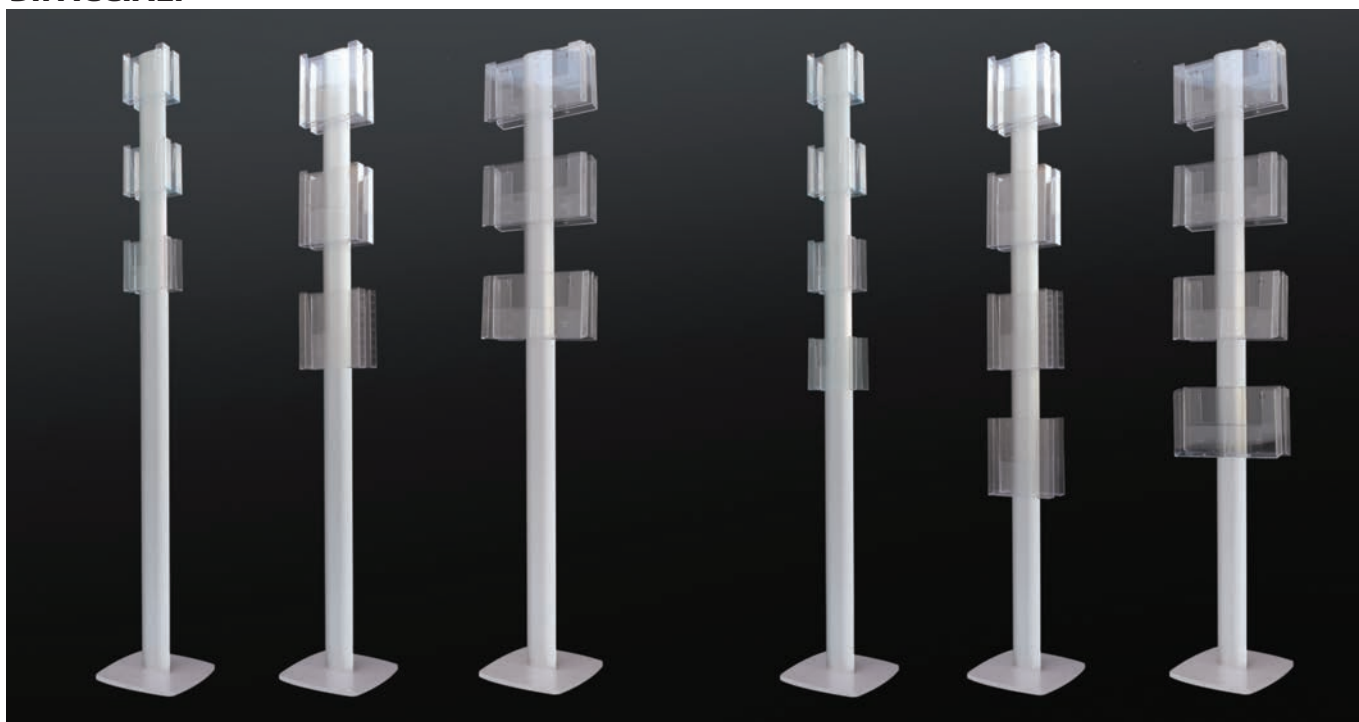

### SCHEDA TECNICA UNIVERSAL BROCHURE 6 TASCHE BIFACCIALE

Codice art.	Descrizione	L.P.
EUUSBR129	3+3 tasche f.to A5 silver	216
EUUSBR130	3+3 tasche f.to A4 silver	248
EUUSBR131	3+3 tasche f.to 2xA5 silver	258
EUUSBR129A	3+3 tasche f.to A5 antracite	216
EUUSBR130A	3+3 tasche f.to A4 antracite	248
EUUSBR131A	3+3 tasche f.to 2xA5 antracite	258

### SCHEDA TECNICA UNIVERSAL BROCHURE 8 TASCHE BIFACCIALE

Codice art.	Descrizione	L.P.
EUUSBR132	4+4 tasche f.to A5 silver	238
EUUSBR133	4+4 tasche f.to A4 silver	268
EUUSBR134	4+4 tasche f.to 2xA5 silver	294
EUUSBR132A	4+4 tasche f.to A5 antracite	238
EUUSBR133A	4+4 tasche f.to A4 antracite	268
EUUSBR134A	4+4 tasche f.to 2xA5 antracite	294

# US PLEX BOX

new  
PRODUCT

Struttura autoportante in alluminio silver con base in PVC-HD cm. 36x36 e tasche porta-brochure in Perspex trasparente ad ALTA CAPIENZA CON UNA PROFONDITÀ DI CM 7; disponibili in due varianti: Frontale e a Bandiera.

*Self-supporting aluminum silver structure with PVC-HD base cm 36x36 and transparent Perspex brochure holder with HIGH CAPACITY CM 7 DEPTH; pockets are available in two variants: front and lateral.*

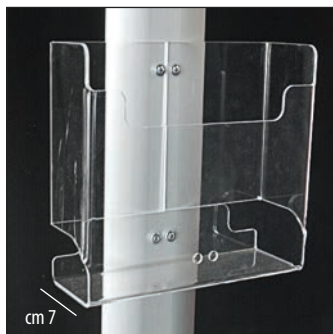

Tasca Frontale

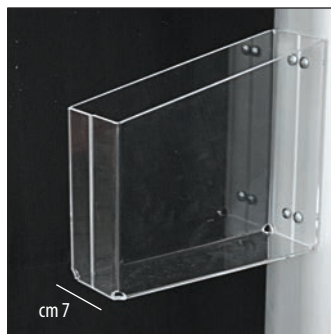

Tasca a Bandiera



cm 170

UNIVERS SYSTEM

32

## SCHEDA TECNICA PLEX BOX ALTA CAPACITÀ

Codice art.	Descrizione	Altezza cm.	F.to tasche	Base cm	L.P.
<b>EUUSPLEBOF</b>	Tasche frontali	170	A4	36x36	264
<b>EUUSPLEBOB</b>	Tasche a bandiera	170	A4	36x36	414

# US FLAG BROCHURE

Struttura autoportante in alluminio silver, altezza cm. 200, base ellittica in PVC-HD cm. 90x30, 3 vaschette porta-brochure in Perspex fumè formato A4, supporto per banner dimensioni cm. 60x200.

*Self-supporting structure in silver aluminum, height cm. 200, elliptical base in PVC - HD cm. 90x30, 3 smoky Perspex pans door - brochure in A4 format, support for banner size cm. 60x200.*



## SCHEDA TECNICA

Codice art.	Altezza cm.	Banner cm.	Base cm.	L.P.
<b>EUUSFLABR</b>	200	60x200	90x30	318

# US NANO

Struttura autoportante in alluminio silver o antracite, altezza cm. 95, base in PVC-HD grigio cm. 29x29, contenitore multi-tasca in Perspex trasparente nel formato A4 sia verticale che orizzontale.

*Self-supporting aluminum silver or anthracite structure, height cm. 95, PVC base - HD grey cm. 29x29, container multi-pocket in transparent Perspex A4 vertical and horizontal.*

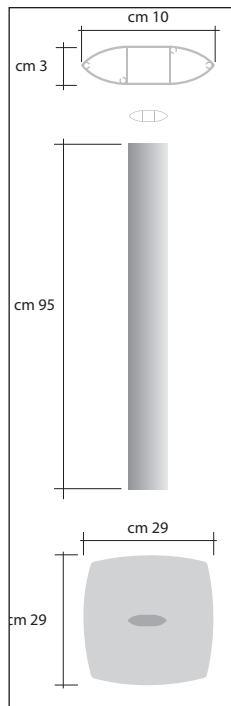

## SCHEMA TECNICA

Codice art.	Descrizione	L.P.
EUUSNANO4A40	4 tasche silver formato A4 orizzontale	170
EUUSNANO4A4	4 tasche silver formato A4 verticale	150
EUUSNANO4A40A	4 tasche antracite formato A4 orizzontale	170
EUUSNANO4A4A	4 tasche antracite formato A4 verticale	150

# US ELITE

Struttura autoportante in alluminio silver o antracite, altezza cm. 160, base in PVC-HD grigio cm. 48x48, contenitore multitasca in Perspex trasparente formato A4.

*Self-supporting aluminum silver or anthracite, height cm. 160, PVC base - HD grey cm. 48x48, container multi-pocket in transparent Perspex A4.*

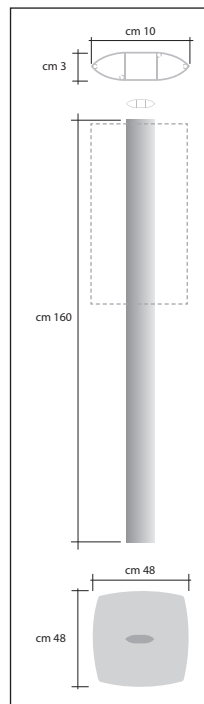

## SCHEMA TECNICA

Codice art.	Descrizione	L.P.
EUUSELI3A4	3 tasche formato A4 monofacciale silver	170
EUUSELI6A4	6 tasche formato A4 bifacciale silver	220
EUUSELI3A4A	3 tasche formato A4 monofacciale antracite	170
EUUSELI6A4A	6 tasche formato A4 bifacciale antracite	220

# US SINGLE

Struttura autoportante in alluminio silver o antracite, altezza cm. 95 e base in PVC-HD grigio cm. 29x29, con staffa e contenitore in Perspex fumè nei formati standard A5, A4 e A3.

*Self-supporting aluminum silver or anthracite, height cm. 95 and PVC base - HD grey cm.29x29, with bracket and container in smoky Perspex in standard sizes A5, A4 and A3.*

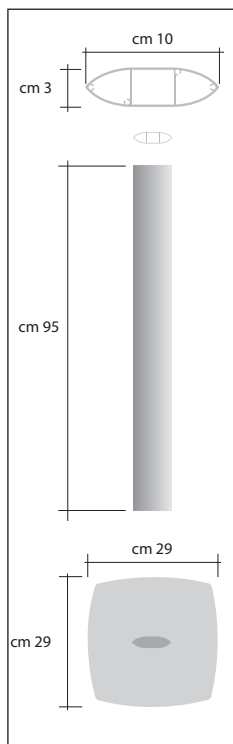

## SCHEMA TECNICA

Codice art.	Descrizione	L.P.
<b>EUUSSINA5</b>	Portabrochure formato A5 silver	130
<b>EUUSSINA4</b>	Portabrochure formato A4 silver	140
<b>EUUSSINA3</b>	Portabrochure formato A3 silver	150
<b>EUUSSINA5A</b>	Portabrochure formato A5 antracite	130
<b>EUUSSINA4A</b>	Portabrochure formato A4 antracite	140
<b>EUUSSINA3A</b>	Portabrochure formato A3 antracite	150

# US BOOK

Struttura autoportante in alluminio silver o antracite, altezza cm. 95 e base in PVC-HD grigio cm. 29x29, con ripiano in Perspex fumè dimensioni cm 50x36.

*Self-supporting aluminum silver or anthracite, height cm. 95 and PVC base - HD grey cm.29x29, with shelf in smoky Perspex size cm 50x36.*

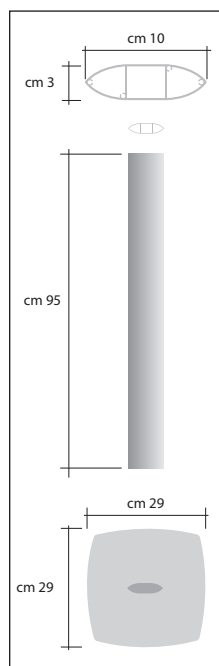

## SCHEMA TECNICA

Codice art.	Descrizione	L.P.
<b>EUUSBOOK</b>	Book Leggio silver cm 50x36	190
<b>EUUSBOOKA</b>	Book Leggio antracite cm 50x36	190

# US SEGNALETICA + ARIANNA

Struttura autoportante in alluminio silver, con serie di cornici Arianna applicabili in diverse configurazioni, e base in PVC-HD cm. 29x29.

Altezza palo cm. 200, cornici larghezza cm. 50, cm. 60 e cm. 70 ed altezza cm. 15.

Silver anodized self-standing structure with Arianna System frames, which is possible to fix in different configurations, PVC HD base size cm. 29x29 and height cm. 200. Frames are available with a width of cm. 50, 60 or 70 and a height of cm. 15.

## SCHEDA TECNICA

Codice art. Silver	Codice art. Antracite	Descrizione	Codice aggiuntivo per configurazione a bandiera	L.P.
USSAB150	USSAB150A	Segnaletica + 1 targa arianna cm.15x50	+ (B)	187
USSAB250	USSAB250A	Segnaletica + 2 targa arianna cm.15x50	+ (B)	222
USSAB350	USSAB350A	Segnaletica + 3 targa arianna cm.15x50	+ (B)	258
USSAB450	USSAB450A	Segnaletica + 4 targa arianna cm.15x50	+ (B)	294
USSAB550	USSAB550A	Segnaletica + 5 targa arianna cm.15x50	+ (B)	330
USSAB650	USSAB650A	Segnaletica + 6 targa arianna cm.15x50	+ (B)	365
USSAB750	USSAB750A	Segnaletica + 7 targa arianna cm.15x50	+ (B)	400
USSAB160	USSAB160A	Segnaletica + 1 targa arianna cm.15x60	+ (B)	190
USSAB260	USSAB260A	Segnaletica + 2 targa arianna cm.15x60	+ (B)	230
USSAB360	USSAB360A	Segnaletica + 3 targa arianna cm.15x60	+ (B)	270
USSAB460	USSAB460A	Segnaletica + 4 targa arianna cm.15x60	+ (B)	309
USSAB560	USSAB560A	Segnaletica + 5 targa arianna cm.15x60	+ (B)	348
USSAB660	USSAB660A	Segnaletica + 6 targa arianna cm.15x60	+ (B)	388
USSAB770	USSAB770A	Segnaletica + 7 targa arianna cm.15x60	+ (B)	428
USSAB170	USSAB170A	Segnaletica + 1 targa arianna cm.15x70	+ (B)	195
USSAB270	USSAB270A	Segnaletica + 2 targa arianna cm.15x70	+ (B)	238
USSAB370	USSAB370A	Segnaletica + 3 targa arianna cm.15x70	+ (B)	282
USSAB470	USSAB470A	Segnaletica + 4 targa arianna cm.15x70	+ (B)	325
USSAB570	USSAB570A	Segnaletica + 5 targa arianna cm.15x70	+ (B)	368
USSAB670	USSAB670A	Segnaletica + 6 targa arianna cm.15x70	+ (B)	412
USSAB770	USSAB770A	Segnaletica + 7 targa arianna cm.15x70	+ (B)	455



# US THEATRE

Struttura autoportante in alluminio silver, adatta ad alloggiare un TV LCD da 42" in versione 16/9. È composta da pali verticali di sezione ellittica con altezze cm. 200, 250 e 300, e traverse orizzontali a sezione ovale.

Monitor non incluso.

Standing structure in silver aluminum, designed to fit a TV LCD 42" in version 16/9. It is composed of vertical poles of elliptical section with heights cm. 200, 250 and 300, and horizontal cross-section oval. Monitor not included



## SCHEDA TECNICA

Codice art.	Descrizione	Alt. cm.	Larg. cm.	L.P.
EUUSTH20080	Struttura per TV LCD 42"	200	80	320
EUUSTH200110	Struttura per TV LCD 50"	200	110	340
EUUSTH200120	Struttura per TV LCD 42"	200	120	340
EUUSTH25080	Struttura per TV LCD 50"	250	80	360
EUUSTH250110	Struttura per TV LCD 42"	250	110	360
EUUSTH250120	Struttura per TV LCD 50"	250	120	360
EUUSTH30080	Struttura per TV LCD 42"	300	80	380
EUUSTH300110	Struttura per TV LCD 50"	300	110	380
EUUSTH300120	Struttura per TV LCD 42"	300	120	380

# US POINT & MINIPPOINT

Struttura autoportante in alluminio silver o antracite, e base in PVC-HD grigio cm. 29x29, con cornice klik-klak nei formati A4 e A3 orizzontale e verticale. Disponibile anche con cornice nera.

*Self-supporting aluminum silver or anthracite structure, and grey PVC-HD base cm. 29x29, with Klik-Klak frame in A4 and A3 size horizontal and vertical. Also available with a black frame.*

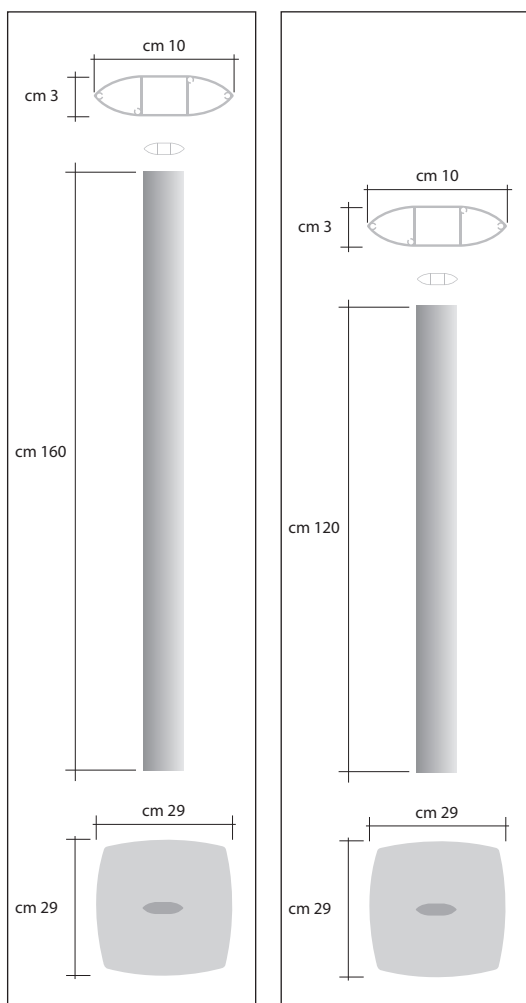

POINT

MINI POINT



## SCHEMA TECNICA

Codice art.	Descrizione	Altezza cm.	L.P.
EUUSPOA4	Point f.to A4 verticale silver	160	150
EUUSPOA3	Point f.to A3 verticale silver	160	160
EUUSMIPOA4	Mini Point f.to A4 verticale silver	120	140
EUUSMIPOA3	Mini Point f.to A3 verticale silver	120	150
EUUSPOA4A	Point f.to A4 verticale antracite	160	150
EUUSPOA3A	Point f.to A3 verticale antracite	160	160
EUUSMIPOA4A	Mini Point f.to A4 verticale antracite	120	140
EUUSMIPOA3A	Mini Point f.to A3 verticale antracite	120	150
EUUSPOA4HO	Point f.to A4 orizzontale silver	160	150
EUUSPOA3HO	Point f.to A3 orizzontale silver	160	160
EUUSMIPOA4HO	Mini Point f.to A4 orizzontale silver	120	140
EUUSMIPOA3HO	Mini Point f.to A3 orizzontale silver	120 <td 150	
EUUSPOA4AHO	Point f.to A4 orizzontale antracite	160	150
EUUSPOA3AHO	Point f.to A3 orizzontale antracite	160	160
EUUSMIPOA4AHO	Mini Point f.to A4 orizzontale antracite	120	140
EUUSMIPOA3AHO	Mini Point f.to A3 orizzontale antracite	120	150



# US INFO

Struttura autoportante in alluminio silver o antracite, altezza cm. 95, base in PVC-HD grigio cm. 29x29, staffa in Perspex fumè e tasca porta-messaggi trasparente disponibile nei formati A4 e A3 sia verticali che orizzontali.

*Self-supporting aluminum silver or anthracite structure, height cm. 95, PVC-HD grey base cm. 29x29, bracket in smoky Perspex and transparent pocket - messages available in A4 and A3 both vertical and horizontal.*

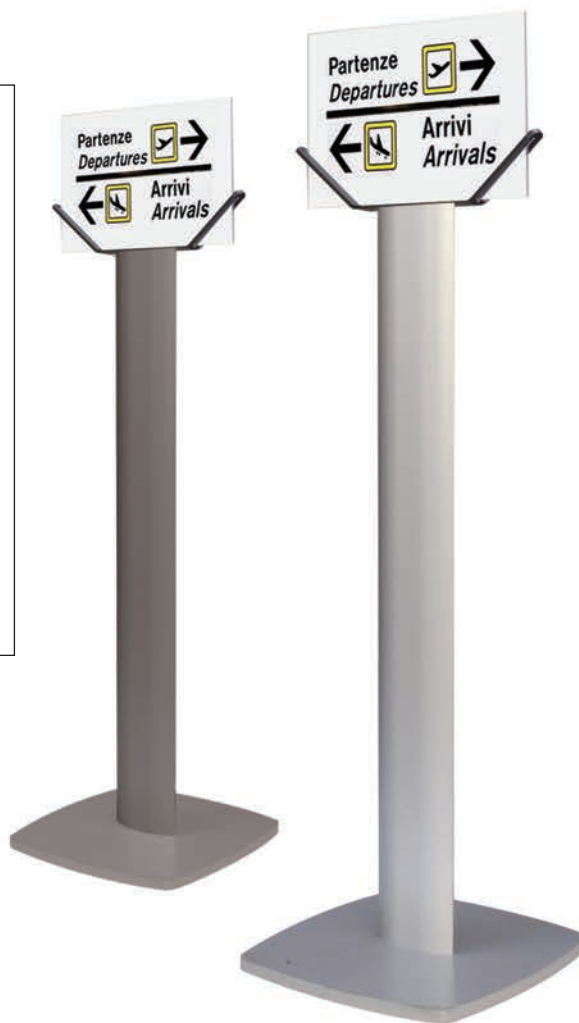
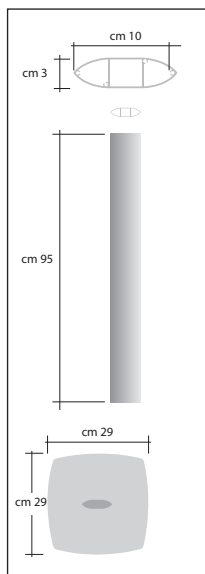
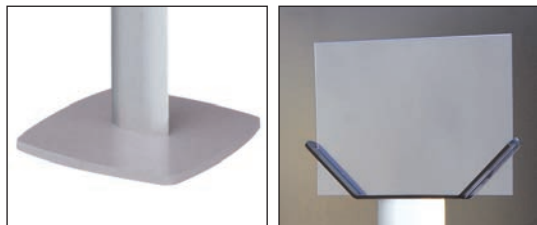

## SCHEMA TECNICA

Codice art.	Descrizione	L.P.
EUUSINA4V	Portamessaggio A4 verticale silver	125
EUUSINA4O	Portamessaggio A4 orizzontale silver	125
EUUSINA3V	Portamessaggio A3 verticale silver	140
EUUSINA3O	Portamessaggio A3 orizzontale silver	140
EUUSINA4VA	Portamessaggio A4 verticale antracite	125
EUUSINA4OA	Portamessaggio A4 orizzontale antracite	125
EUUSINA3VA	Portamessaggio A3 verticale antracite	140
EUUSINA3OA	Portamessaggio A3 orizzontale antracite	140

# US NOTE

Struttura autoportante in alluminio silver o antracite, altezza cm. 95, base in PVC-HD grigio cm. 29x29 e staffa in Perspex fumè che sostiene una cornice klik-klak nei formati A4 e A3. Disponibile anche con cornice nera.

*Self-supporting aluminum silver or anthracite, height cm. 95, PVC-HD base, grey cm. 29x29 and smoky Perspex bracket that supports a frame klik-klak in A4 and A3 sizes. Also available with a black frame.*

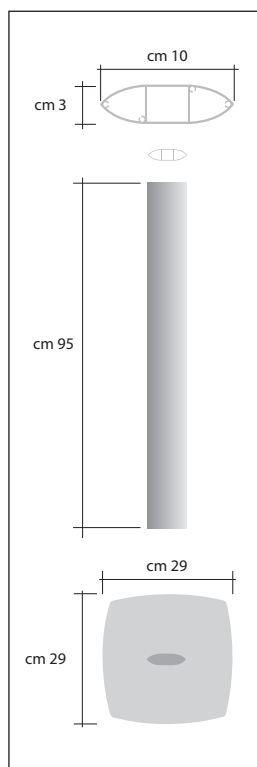

## SCHEMA TECNICA

Codice art.	Descrizione	L.P.
EUUSNOA4V	Klik klak formato A4 silver	140
EUUSNOA3V	Klik klak formato A3 verticale silver	150
EUUSNOA3O	Klik klak formato A3 orizzontale silver	150
EUUSNOA4VA	Klik klak formato A4 antracite	140
EUUSNOA3VA	Klik klak formato A3 verticale antracite	150
EUUSNOA3OA	Klik klak formato A3 orizzontale antracite	150

# US BARRIER

Struttura autoportante per l'esposizione di banner, in alluminio silver o antracite, e base in PVC-HD grigio. Disponibile in diverse configurazioni standard e su richiesta personalizzabile in qualsiasi dimensione.

*Self-supporting for display banners, aluminum silver or anthracite, and PVC-HD grey base. Available in different standard configurations and on request customizable in whatever size.*



## SCHEDA TECNICA SILVER

Codice art.	Colore	Altezza/Largh. cm.	Base cm.	L.P.
EUUSBA1510	Silver	150x100	36x36	260
EUUSBA1515	Silver	150x150	36x36	274
EUUSBA1520	Silver	150x200	36x36	324
EUUSBA1525	Silver	150x250	36x36	343
EUUSBA1530	Silver	150x300	36x36	362
EUUSBA1540	Silver	150x400	36x36	400
EUUSBA205	Silver	200x50	29x29	262
EUUSBA207	Silver	200x75	36x36	272
EUUSBA2010	Silver	200x100	36x36	282
EUUSBA2015	Silver	200x150	36x36	302
EUUSBA2020	Silver	200x200	48x48	474
EUUSBA2025	Silver	200x250	48x48	493
EUUSBA2030	Silver	200x300	48x48	512
EUUSBA2040	Silver	200x400	48x48	550
EUUSBA2510	Silver	250x100	48x48	482
EUUSBA2515	Silver	250x150	48x48	502
EUUSBA2520	Silver	250x200	48x48	502
EUUSBA2525	Silver	250x250	48x48	521
EUUSBA2530	Silver	250x300	48x48	540
EUUSBA2540	Silver	250x400	48x48	580
EUUSBA3010	Silver	300x100	48x48	510
EUUSBA3015	Silver	300x150	48x48	530
EUUSBA3020	Silver	300x200	48x48	530
EUUSBA3025	Silver	300x250	48x48	550
EUUSBA3030	Silver	300x300	48x48	578
EUUSBA3040	Silver	300x400	48x48	610

## SCHEDA TECNICA ANTRACITE

Codice art.	Colore	Altezza/Largh. cm.	Base cm.	L.P.
EUUSBA1510A	Antracite	150x100	36x36	260
EUUSBA1515A	Antracite	150x150	36x36	274
EUUSBA1520A	Antracite	150x200	36x36	324
EUUSBA1525A	Antracite	150x250	36x36	343
EUUSBA1530A	Antracite	150x300	36x36	362
EUUSBA1540A	Antracite	150x400	36x36	400
EUUSBA205A	Antracite	200x50	29x29	262
EUUSBA207A	Antracite	200x75	36x36	272
EUUSBA2010A	Antracite	200x100	36x36	282
EUUSBA2015A	Antracite	200x150	36x36	302
EUUSBA2020A	Antracite	200x200	48x48	474
EUUSBA2025A	Antracite	200x250	48x48	493
EUUSBA2030A	Antracite	200x300	48x48	512
EUUSBA2040A	Antracite	200x400	48x48	550
EUUSBA2510A	Antracite	250x100	48x48	482
EUUSBA2515A	Antracite	250x150	48x48	502
EUUSBA2520A	Antracite	250x200	48x48	502
EUUSBA2525A	Antracite	250x250	48x48	521
EUUSBA2530A	Antracite	250x300	48x48	540
EUUSBA2540A	Antracite	250x400	48x48	580
EUUSBA3010A	Antracite	300x100	48x48	510
EUUSBA3015A	Antracite	300x150	48x48	530
EUUSBA3020A	Antracite	300x200	48x48	530
EUUSBA3025A	Antracite	300x250	48x48	550
EUUSBA3030A	Antracite	300x300	48x48	578
EUUSBA3040A	Antracite	300x400	48x48	610

ALTRE MISURE SU RICHIESTA



# US BARRIER REGOLABILE

**new  
PRODUCT**

Struttura autoportante per l'esposizione di banner, disponibile in alluminio silver o antracite, con base in PVC-HD grigia. Disponibile in diverse configurazioni standard e su richiesta realizzabile in qualsiasi dimensione. Dispone di barra inferiore regolabile manualmente in altezza in modo semplice e veloce per adattarsi a qualsiasi formato grafica.

*Self supporting structure for display banners, aluminum silver or anthracite color, with grey PVC-HD base. Available in different standard configurations and upon request it is doable in whatever size. It provides of bottom rod with easy manually customizable height, to adapt the structure for whatever graphic size.*

## SCHEMA TECNICA

Codice art.	Colore	Altezza/Largh. cm.	Base cm.	L.P.
EUUSBARE205	Silver	200x50	29x29	370
EUUSBARE207	Silver	200x75	36x36	380
EUUSBARE2010	Silver	200x100	36x36	392
EUUSBARE2015	Silver	200x150	36x36	420
EUUSBARE2020	Silver	200x200	48x48	594
EUUSBARE2025	Silver	200x250	48x48	620
EUUSBARE2030	Silver	200x300	48x48	642
EUUSBARE2040	Silver	200x400	48x48	690
EUUSBARE2510	Silver	250x100	48x48	592
EUUSBARE2515	Silver	250x150	48x48	620
EUUSBARE2520	Silver	250x200	48x48	622
EUUSBARE2525	Silver	250x250	48x48	646
EUUSBARE2530	Silver	250x300	48x48	670
EUUSBARE2540	Silver	250x400	48x48	720
EUUSBARE3010	Silver	300x100	48x48	620
EUUSBARE3015	Silver	300x150	48x48	640
EUUSBARE3020	Silver	300x200	48x48	650
EUUSBARE3025	Silver	300x250	48x48	675
EUUSBARE3030	Silver	300x300	48x48	708
EUUSBARE3040	Silver	300x400	48x48	750

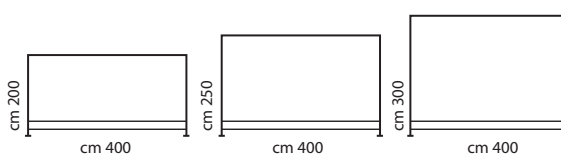
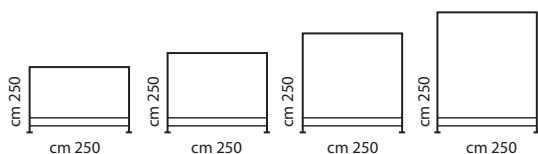
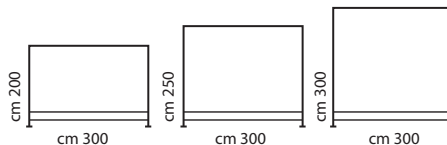
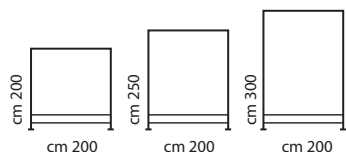
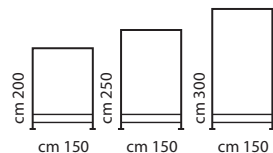
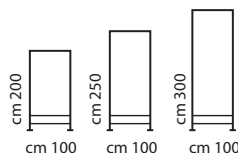
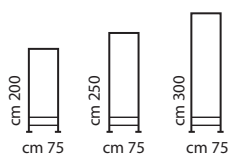
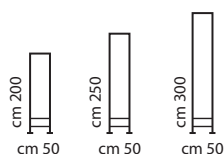
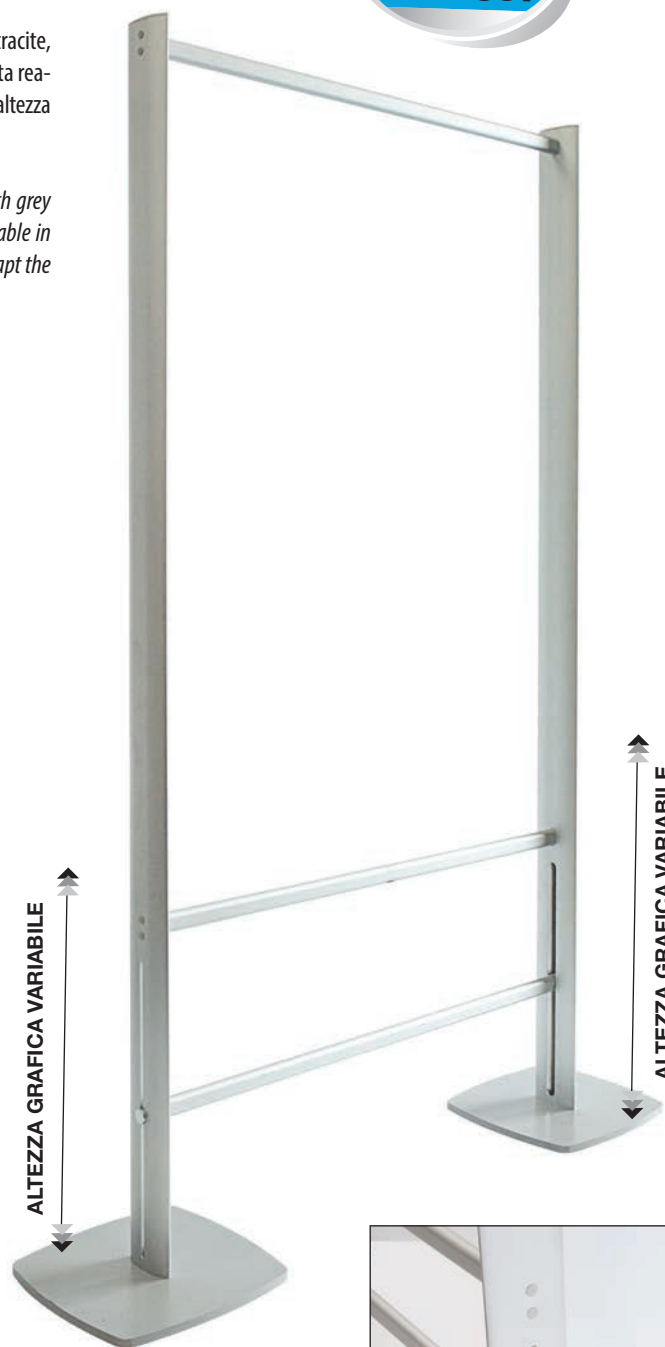

**ALTRE MISURE SU RICHIESTA**

# US NEW WALL

Parete monofacciale autoportante in alluminio silver o antracite, con pratico sistema di aggancio grafiche tramite strisce magnetiche adesive già applicate. La struttura è composta da un modulo Start, composto da 2 colonne verticali e barre orizzontali, e da moduli aggiuntivi composti da 1 colonna e traverse orizzontali; è possibile realizzare fondali grafici di grandi dimensioni.

*Wall sided freestanding aluminum silver or anthracite, with practical fastening system graphics via adhesive magnetic strips already applied. The structure is composed by a module Start, composed of two vertical columns and horizontal bars, and by additional modules consisting of 1 column and horizontal cross members; It is possible to realize backdrops large graphics.*

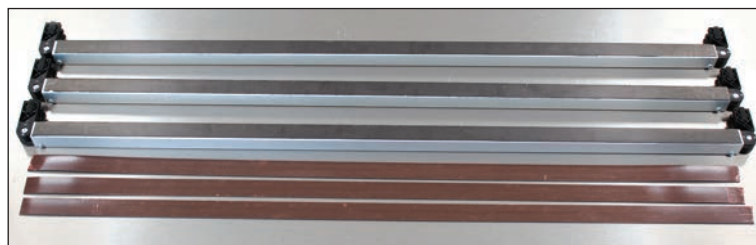
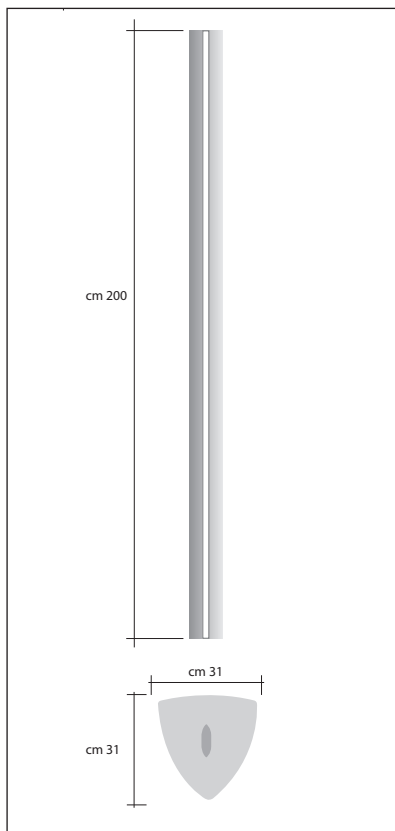

## VERSIONE ANTRACITE





## SCHEMA TECNICA

Codice art.	Descrizione	Colore	Altezza cm.	Base cm.	L.P.
EUUSNWST200	Modulo start 2 colonne + 2 traverse	Silver	200	31x31	375
EUUSNWST250	Modulo start 2 colonne + 3 traverse	Silver	250	31x31	474
EUUSNWST300	Modulo start 2 colonne + 3 traverse	Silver	300	31x31	510
EUUSNWAG200	Modulo agg. 1 colonna + 2 traverse	Silver	200	31x31	250
EUUSNWAG250	Modulo agg. 1 colonna + 3 traverse	Silver	250	31x31	340
EUUSNWAG300	Modulo agg. 1 colonna + 3 traverse	Silver	300	31x31	360
EUUSNWST200A	Modulo start 2 colonne + 2 traverse	Antracite	200	31x31	375
EUUSNWST250A	Modulo start 2 colonne + 3 traverse	Antracite	250	31x31	474
EUUSNWST300A	Modulo start 2 colonne + 3 traverse	Antracite	300	31x31	510
EUUSNWAG200A	Modulo agg. 1 colonna + 2 traverse	Antracite	200	31x31	250
EUUSNWAG250A	Modulo agg. 1 colonna + 3 traverse	Antracite	250	31x31	340
EUUSNWAG300A	Modulo agg. 1 colonna + 3 traverse	Antracite	300	31x31	360

# US DESK



Desk con struttura in alluminio silver, altezza cm. 90, base e ripiano in PVC espanso grigio scuro antigraffio spessore mm. 19. Disponibile in due grandezze, Standard e XL.

Desk with aluminum silver structure, height cm. 90, base and shelf in anti-scratch PVC foam dark silver thickness mm. 19. Available in two sizes, Standard and XL.



## VERSIONE STANDARD

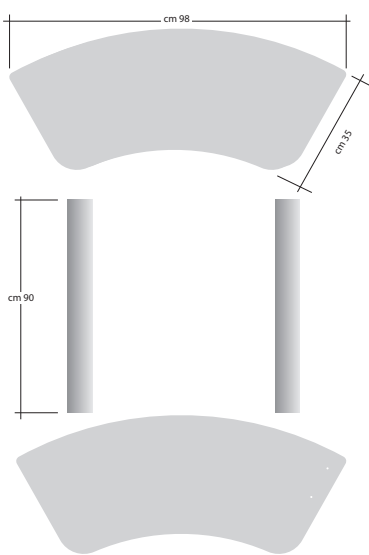

## VERSIONE XL

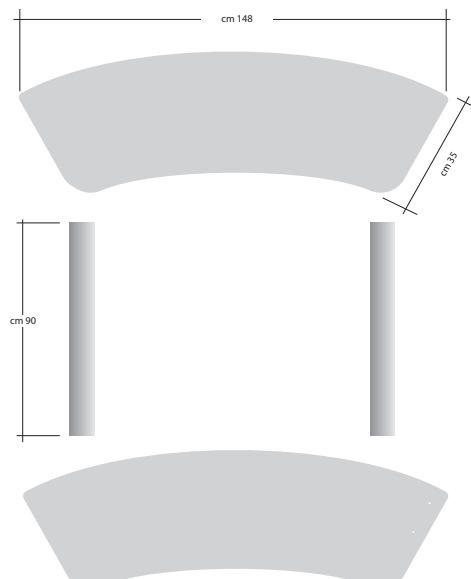

### SCHEMA TECNICA

Codice art.	Descrizione	Pannello cm	L.P.
EUUSDESK	Desk Standard cm.98x35x90	98,5x90	300
EUUSDESKXXL	Desk XL cm. 148x35x90	148,5x90	400
SNSACCA	Sacca in tessuto XL	-	50

# LED US STYLE

Struttura autoportante in alluminio silver, con illuminazione a LED per l'esposizione di poster monofacciali e bifacciali in cornici klik klak nei formati cm. 50x70, cm. 70x100 e cm. 100x140. Optional le mensole porta-brochure in Perspex fumè (solo per monofacciale).

*Standing structure in silver aluminum, with LED lighting for the exhibition of single-sided and double-sided poster frames in klik Klak in sizes cm. 50x70, 70x100 and cm. 100x140. Optional shelves door - brochure in smoky Perspex (only for single-sided).*

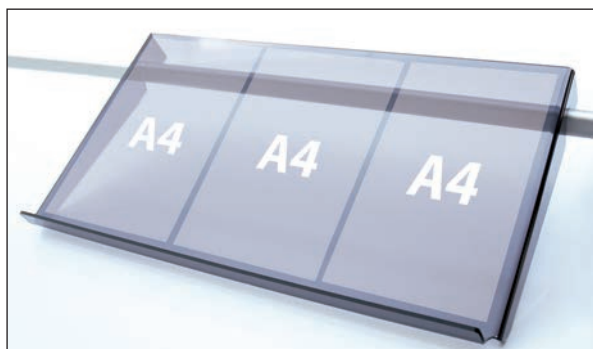
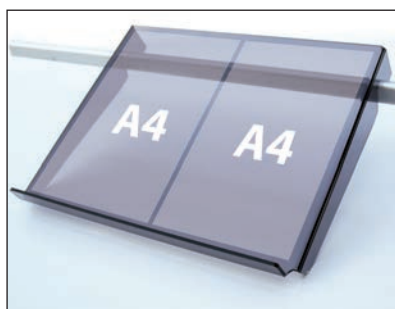

## SCHEMA TECNICA

Codice art.	Descrizione	L.P.
<b>EUUSSTLED57MO</b>	Klik klak Led 50x70 monofacciale	710
<b>EUUSSTLED710MO</b>	Klik klak Led 50x70 bifacciale	1094
<b>EUUSSTLED1014MO</b>	Klik klak Led 70x100 monofacciale	963
<b>EUUSSTLED57BI</b>	Klik klak Led 70x100 bifacciale	1585
<b>EUUSSTLED710BI</b>	Klik klak Led 100x140 monofacciale	1400
<b>EUUSSTLED1014BI</b>	Klik klak Led 100x140 bifacciale	2438
<b>EUUSRIP1A4</b>	Mensola fumè per 1 f.to A4	50
<b>EUUSRIP2A4</b>	Mensola fumè per 2 f.ti A4	65
<b>EUUSRIP3A4</b>	Mensola fumè per 3 f.ti A4	82

# LED US POINT & MINIPPOINT

Struttura autoportante in alluminio silver, con illuminazione a LED, base in PVC-HD grigio cm. 29x29, cornice klik-klak nei formati A4 e A3.

Self-supporting structure in silver aluminum, with LED light, grey PVC - HD base cm. 29x29, Klik - Klak frame in A4 and A3 sizes.

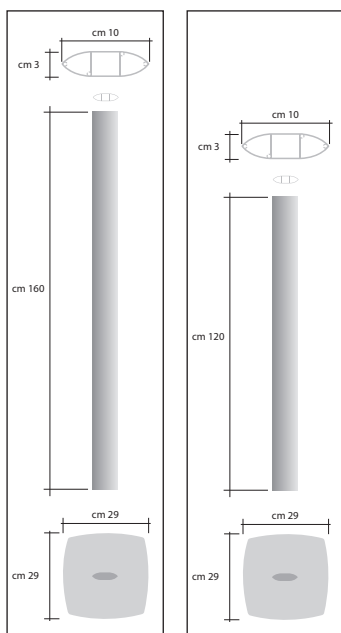

POINT LED

MINI POINT LED

**LED TECHNOLOGY**



## SCHEDA TECNICA

Codice art.	Descrizione	Altezza cm.	L.P.
EUUSMPOLEDA4	Klik klak LED alt. f.to A4	120	220
EUUSMPOLEDA3	Klik klak LED alt. f.to A3	120	280
EUUSPOLEDA4	Klik klak LED alt. f.to A4	160	230
EUUSPOLEDA3	Klik klak LED alt. f.to A3	160	290



# LED US NOTE

Struttura autoportante in alluminio silver o antracite, altezza cm. 95, base in PVC-HD grigio cm. 29x29, e staffa in Perspex fumè per cornice klik-klak con illuminazione a LED nei formati A4 e A3.

Self-supporting aluminum silver or anthracite, height cm. 95, grey PVC - HD base cm. 29x29, and bracket for smoky Perspex frame Klik - Klak with LED lighting in A4 and A3.

**LED TECHNOLOGY**

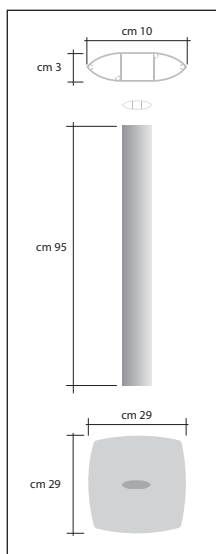

## SCHEDA TECNICA

Codice art.	Descrizione	L.P.
EUUSNOLEDA4	klik klak LED formato A4 silver	220
EUUSNOLEDA3	klik klak LED formato A3 verticale silver	280
EUUSNOLEDA4A	klik klak LED formato A4 antracite/silver	220
EUUSNOLEDA3A	klik klak LED formato A3 verticale antracite/silver	280



# ROLL-UP

NEW ROLLER ONE 1.0 E 2.0  
NEW ECONOMY ROLLER  
NEW ROLLER MONO  
BUDGET ROLLER FUN  
ELITE ROLLER FUN  
NEW ROLLER FUN PLUS  
NEW SUPREME INTERCAMBIABILE  
ROLLER GOTHIC  
MAMMUTH  
NEW ROLL-UP XXL  
TECH ROLLER  
ROLL-UP THE WIN  
ROLLER TRIANGLE  
ROLLER ANGLE  
ROLLER ESSENTIAL  
ROLL-UP MAGNETIC  
ROLLER BIFACCIALE  
ROLLER DOUBLE  
PLASTIC OUTDOOR  
NEW OUTDOOR  
STANDELLE  
X BANNER  
INTERCAMBIABILE MINI  
SUPPORTI PER DISPLAY, ROLL-UP, POP-UP  
SUPPORTI SPECIALI KERNOW-JET

# NEW ROLLER ONE 1.0 & 2.0

Roll-up monofacciale autoavvolgente in alluminio anodizzato e piede singolo, con barra superiore a pinza e biadesivo in quella inferiore. Sacca compresa nel prezzo.

*Monofacial anodized aluminium Roll-up and single foot, with upper rod pincers and lower double-sided tape. Bag included with the price.*

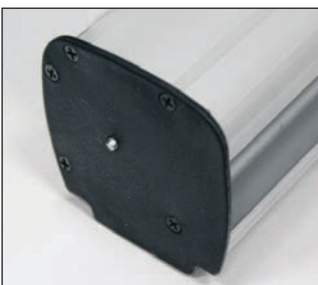
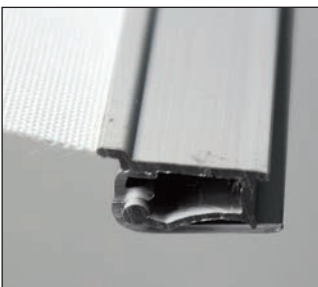

ROLLER 1.0



ROLLER 2.0

## SCHEDA TECNICA ROLLER ONE 1.0

Codice art.	Grafica cm.	Imballo cm.	Peso Kg.	Colore	L.P.
BMONE50160	50x160	11x11x56	1.5	Silver/Nero	22
BMONE60160	60x160	11x11x66	1.8	Silver/Nero	24
BMONE70180	70x180	11x11x76	2.1	Silver/Nero	26
BMONE80200	80x200	11x11x86	2.4	Silver/Nero	28

## SCHEDA TECNICA ROLLER ONE 2.0

Codice art.	Grafica cm.	Imballo cm.	Peso Kg.	Colore	L.P.
BMONEW85200	85x200	11x11x91	2.8	Silver/Nero	30
BMONEW100200	100x200	11x11x106	3.3	Silver/Nero	38
BMONEW120200	120x200	11x11x126	3.9	Silver/Nero	45





# NEW ECONOMY ROLLER



Roll-up economico monofacciale in alluminio Silver, disponibile in tre dimensioni: asta verticale frazionata in tre parti con elastico interno, sistema di aggancio grafica, inferiore mediante biadesivo, superiore con asta con chiusura a pinza. Sacca compresa nel prezzo.

*Roll-Up single side made by aluminium silver, available in three different sizes. The vertical rod is divided in three parts with an interior stretchy, hook graphic lower by double-sided tape and upper with tongs closure. Bag is included in the price.*



## SCHEMA TECNICA

Codice art.	Grafica cm.	Imballo cm.	Peso Kg	Colore	L.P.
WKECOROL85	85x200	11x11x55	2,3	Silver	30
WKECOROL100	100x200	11x11x90	3,3	Silver	38
WKECOROL120	120x200	11x11x125	3,9	Silver	45

# NEW ROLLER MONO

Roll-up monofacciale autoavvolgente in alluminio, con aggancio grafica superiore tramite asta con chiusura a pinza, ed inferiore con biadesivo. Sacca compresa nel prezzo.

*Monofacial aluminium Roll-up, with upper hook graphic through beam with pincers latch, and lower with double-sided tape. Bag included with the price.*

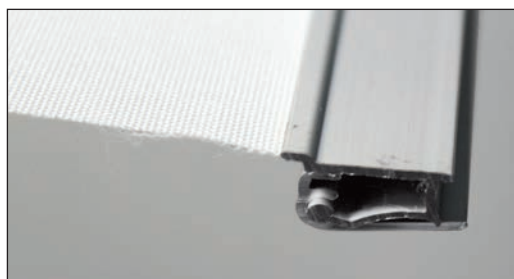

cm 150



cm 120



cm 100



cm 85

## SCHEDA TECNICA

Codice art.	Grafica cm.	Imballo cm.	Peso Kg.	Colore	L.P.
DWROM085200	85x205	11x11x90	3	Silver/Chrome	45
DWROM100200	100x205	11x11x105	3.8	Silver/Chrome	55
DWROM120200	120x205	11x11x125	4.5	Silver/Chrome	65
DWROM150200	150x205	11x11x155	4.8	Silver/Chrome	80

# BUDGET ROLLER FUN

Roll-up monofacciale autoavvolgente in alluminio e placche laterali cromate ; fissaggio grafica superiore tramite barra con chiusura a pinza, inferiore con biadesivo, sacca per il trasporto compresa.

*Monofacial Silver Aluminium Roll-up, with chromed end caps; the upper graphic attachment through rod with pincers latch, lower with double-sided tape. Bag included with the price.*



## SCHEDA TECNICA BUDGET ROLLER FUN

Codice art.	Grafica cm.	Imballo cm.	Peso Kg.	Colore	L.P.
BMBUFU85200	85x200	23x13x95	3.0	Silver/Chrome	80

# ELITE ROLLER FUN

Roll-up monofacciale autoavvolgente in alluminio e placche laterali cromate ; fissaggio grafica superiore tramite barra con chiusura a pinza, inferiore con biadesivo, sacca per il trasporto compresa.

*Monofacial Silver Aluminium Roll-up, with chromed end caps; the upper graphic attachment through rod with pincers latch, lower with double-sided tape. Bag included with the price.*



## SCHEDA TECNICA

Codice art.	Grafica cm.	Imballo cm.	Peso Kg.	Colore	L.P.
WKEROFU85200	85x200	11x11x90	3	Silver/Chrome	90

# NEW ROLLER FUN PLUS

**new  
PRODUCT**

Roll-up monofacciale autoavvolgente in alluminio silver e placche laterali cromate, con piedini regolabili; fissaggio grafica superiore tramite barra con chiusura a pinza, inferiore con biadesivo. Sacca compresa nel prezzo.

*Monofacial aluminium Roll-up, with lateral chromed end caps, with adjustable base; upper fixing graphic through beam with pincers, lower with double-sided tape. Bag included with the price.*

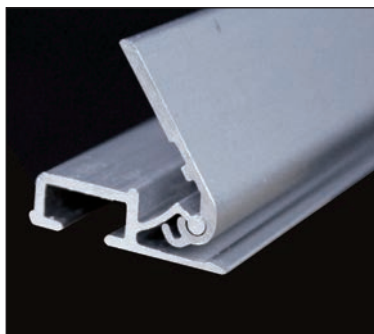
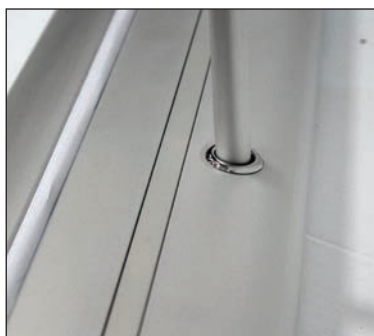

## SCHEDA TECNICA ROLLER FUN

Codice art.	Grafica cm.	Imballo cm.	Peso Kg.	Colore	L.P.
DWROFU85200	85x200	25x13x95	4.7	Silver/Chrome	100
DWROFU100200	100x200	25x13x109.5	5.7	Silver/Chrome	125
DWROFU120200	120x200	25x13x129.5	7.0	Silver/Chrome	138
DWROFU150200	150x200	25x13x159.5	8.2	Silver/Chrome	158

# NEW SUPREME INTERCAMBIABILE

Roll-up monofacciale autoavvolgente in alluminio silver con placche laterali cromate, piedini regolabili e barra telescopica con altezza regolabile da un minimo di cm. 150 ad un massimo di cm. 220; grafica intercambiabile fissata superiormente tramite barra con chiusura a pinza ed inferiormente con biadesivo. Sacca compresa nel prezzo.

*Monofacial aluminum roll-up with aluminum silver case and chromed end caps, with adjustable base and telescopic pole among a minimum height of cm. 150 to a maximum of cm. 220; upper fixing graphic through beam with pincers, lower with double-sided tape. Transport bag included with the price.*



## SCHEMA TECNICA

Codice art.	Grafica cm.	Imballo cm.	Peso Kg.	Colore	L.P.
DWSUP85220	85X150/220	52x28x97	4.2	Silver/Chrome	175
DWSUP100220	100 X150/220	52x28x112	4.7	Silver/Chrome	210
DWSUP120220	120 X150/220	52x28x132	6	Silver/Chrome	234
DWSUP150220	150 X150/220	52x28x162	7.8	Silver/Chrome	308

# ROLLER GOTHIC

Roll-up monofacciale in alluminio con placche laterali cromate; fissaggio grafica superiore tramite barra con chiusura a pinza, inferiore con biadesivo, sacca per il trasporto compresa.

*Monofacial aluminium Roll-up, with lateral chromed end caps; upper hook graphic through beam with pincers, lower with double-sided tape. Bag included with the price.*



## SCHEDA TECNICA

Codice art.	Grafica cm.	Imballo cm.	Peso Kg.	Colore	L.P.
<b>BMROG085200</b>	85x200	13x13x90	3.6	Silver/Chrome	87
<b>BMROG0100200</b>	100x200	13x13x107	4.1	Silver/Chrome	98
<b>BMROG0120200</b>	120x200	13x13x127	4.6	Silver/Chrome	115



cm 200

# MAMMUTH

Roll-up monofacciale autoavvolgente di grandi dimensioni, con aste verticali telescopiche e cassa in alluminio silver con particolari cromati; fissaggio grafica superiore tramite barra con chiusura a pinza, inferiore con biadesivo. Sacca compresa nel prezzo.

*Great dimension monofacial Roll-up, with vertical telescopic beam and with chromed fixed support base; Upper fixing graphic through beam with pincers (snap), lower with double-sided tape. Transport bag included with the price.*



## SCHEDA TECNICA

Codice art.	Grafica cm.	Imballo cm.	Peso Kg.	Colore	L.P.
<b>DWROMH200300</b>	200x200/220/250/300	210x17x15	10.3	Silver	300

cm 300

cm 250

cm 220

cm 200



# NEW ROLL - UP XXL

Roll-up autoavvolgente di grandi dimensioni, monofacciale con cassa in alluminio, doppio piede e placche laterali cromate; fissaggio grafica superiore tramite barra con chiusura a pinza, inferiore con biadesivo. Sacca compresa nel prezzo.

*Big dimension monofacial Roll-up with aluminium silver case, double foot and lateral chromed caps; Upper fixing graphic through beam with pinners, lower with double-sided tape. Transport bag included with the price.*



## SCHEDA TECNICA

Codice art.	Grafica cm.	Imballo cm.	Peso Kg.	Colore	L.P.
DWROXXL150200	150x205	16x16x160	8.5	Silver/Chrome	210
DWROXXL180200	180x205	16x16x190	9.5	Silver/Chrome	230
DWROXXL200200	200x205	16x16x210	10.5	Silver/Chrome	275
DWROXXL240200	240x200	16x16x252	12.5	Silver/Chrome	300

# TECH ROLLER

Roll-up monofacciale in alluminio silver, autoavvolgente con fissaggio grafica superiore tramite barra con chiusura a pinza, inferiore con biadesivo. Sacca compresa nel prezzo.

*Monofacial silver aluminium Roll-up with upper hook graphic through beam with pincers latch and lower with double-sided tape. Bag included with the price.*



FINO AD  
ESAURIMENTO



ROLL - UP

54

## SCHEDA TECNICA

Codice art.	Grafica cm.	Imballo cm.	Peso Kg.	Colore	L.P.
DWTER085200	85x205	42x28x98	2.8	Silver	75

# ROLL UP THE WIN

Roll-up monofacciale autoavvolgente in alluminio silver con placche laterali cromate ed asta telescopica; fissaggio grafica superiore tramite barra con chiusura a pinza, inferiore con biadesivo. Sacca compresa nel prezzo.

*Monofacial silver aluminium Roll-up, with lateral chromed end caps telescopic beam; upper hook graphic through beam with pincers, lower with double-sided tape. Bag included with the price.*



FINO AD  
ESAURIMENTO



ALTEZZA VARIABILE DA CM 160 a 225



## SCHEDA TECNICA

Codice art.	Grafica cm.	Imballo cm.	Peso Kg.	Colore	L.P.
DWTHWI85225	85x(160-225)	37x21x94	3.1	Silver/Chrome	60



# ROLLER TRIANGLE

Roll-up monofacciale autoavvolgente in alluminio silver con placche laterali cromate; fissaggio grafica superiore tramite barra con chiusura a pinza, inferiore con biadesivo. Sacca compresa nel prezzo.

*Monofacial silver aluminium Roll-up, with lateral and chromed lateral caps; upper graphic attachment through rod with pincers latch, lower with double-sided tape. Bag included with the price.*



FINO AD ESAURIMENTO



## SCHEDA TECNICA

Codice art.	Grafica cm.	Imballo cm.	Peso Kg	Colore	L.P.
APROTRI85200	85x200	97x26x50	4.6	Silver/Chrome	60

# ROLLER ANGLE

Roll-up monofacciale autoavvolgente con cassa in alluminio Silver e placche laterali cromate e piedini regolabili; grazie all'asta telescopica consente di fissare la grafica a diverse altezze da cm. 200 a cm. 240. Fissaggio grafica superiore tramite barra con chiusura a pinza, inferiore con biadesivo. Sacca compresa nel prezzo.

*Monofacial Roll-up, with silver aluminium case and chromed lateral caps and adjustable bases; thanks to the telescopic beam it allows to fix graphics to different heights from cm. 200 to cm. 240. Upper graphic attachment through rod with pincers latch, lower with double-sided tape. Bag included with the price.*

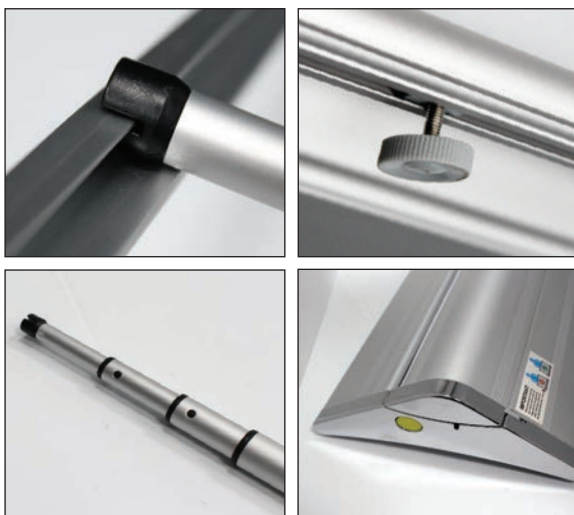

FINO AD ESAURIMENTO



## SCHEDA TECNICA

Codice art.	Grafica cm.	Imballo cm.	Peso Kg.	Colore	L.P.
APROANG85240	85x(205-240)	24x12x95	5	Silver/Chrome	100

# ROLLER ESSENTIAL

Roll-up monofacciale autoavvolgente con cassa in alluminio Silver di sezione circolare e piedi di sostegno fissi cromati. Fissaggio grafica superiore tramite barra con chiusura a pinza, inferiore con biadesivo, sacca per il trasporto compresa.

*Monofacial aluminium Roll-up with aluminium silver case with circular section and with chromed fixed support base. Upper fixing graphic through beam with pincers, lower with double-sided tape. Transport bag included with the price.*

FINO AD  
ESAURIMENTO

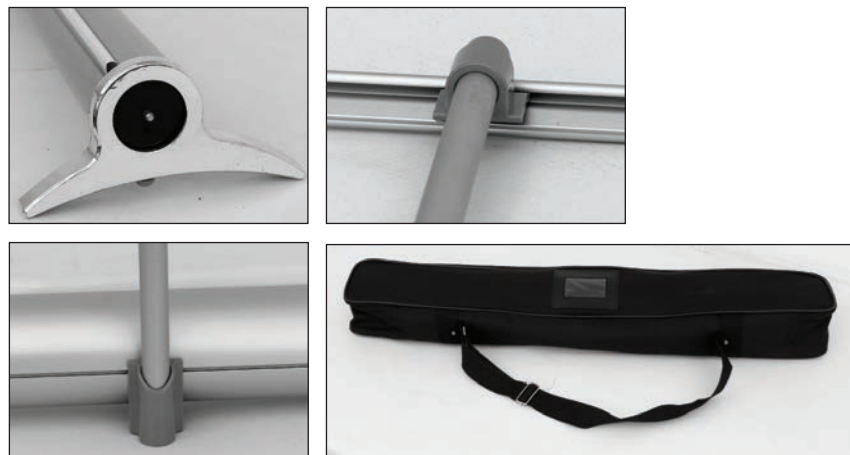

## SCHEDA TECNICA

Codice art.	Grafica cm.	Imballo cm.	Peso Kg.	Colore	L.P.
UTROES80200	80x200	12x10x86	2.5	Silver/Chrome	40

# ROLL UP MAGNETIC

Roll-up monofacciale autoavvolgente in alluminio silver con piedi e placche laterali cromate; l'asta superiore integra dei magneti che permettono di agganciare più grafiche in sequenza. Fissaggio grafica superiore tramite barra con chiusura a pinza, inferiore con biadesivo. Sacca compresa nel prezzo.

*Monofacial silver aluminium Roll-up, with lateral and chromed lateral caps; the upper rod with the magnets that allow to show more graphics in sequence. Fixing upper graphics through rod with pincers latch, lower with double-sided tape. Bag included with the price.*

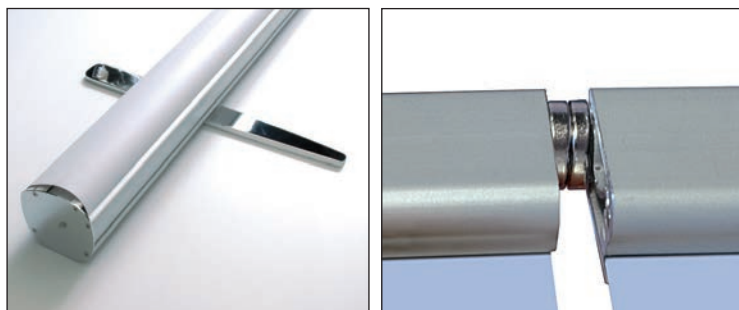

## SCHEDA TECNICA

Codice art.	Grafica cm.	Imballo cm.	Peso Kg.	Colore	L.P.
DWROMA85200	85x205	34x27x95	5.6	Silver/Chrome	110
DWROMA100200	100x205	37x27x109	6.5	Silver/Chrome	140
DWROMA120300	120x305	128x38x14	7.5	Silver/Chrome	190

# NEW ROLLER BIFACCIALE

Roll-up bifacciale autoavvolgente in alluminio silver; fissaggio grafica superiore tramite barra con chiusura a pinza, inferiore con biadesivo. Sacca compresa nel prezzo.

*Bifacial aluminium silver Roll-up; Upper fixing graphic through beam with pincers, lower with double-sided tape. Bag included with the price.*



## SCHEDA TECNICA

Codice art.	Grafica cm.	Imballo cm.	Peso Kg.	Colore	L.P.
DWROBI85200	85x203	20x11x90	5	Silver/Chrome	70
DWROBI100200	100x203	20x11x105	5.5	Silver/Chrome	80
DWROBI120200	120x203	20x11x125	6	Silver/Chrome	100



# ROLLER DOUBLE

Roll-up bifacciale autoavvolgente in alluminio silver e finiture cromate, con piedini regolabili; fissaggio grafica superiore tramite barra con chiusura a pinza, inferiore con biadesivo. Sacca compresa nel prezzo.

*Bifacial Roll-up, with silver aluminium case and chromed finishing with adjustable bases; upper graphic attachment through rod with pincers latch, lower with double-sided tape. Bag included with the price.*

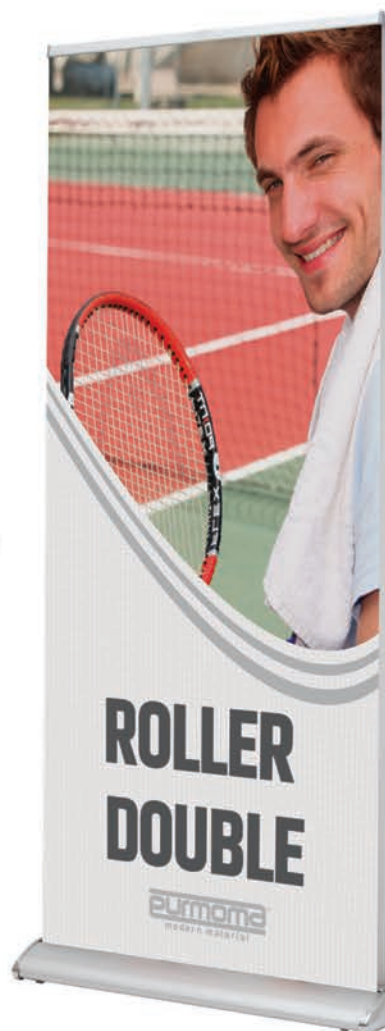

## SCHEDA TECNICA

Codice art.	Grafica cm.	Imballo cm.	Peso Kg.	Colore	L.P.
DWROD085200	85x200	25x13x95	6.1	Silver/Chrome	150
DWROD0100200	100x200	25x13x109.5	8.0	Silver/Chrome	180

# PLASTIC OUTDOOR

Roll-up bifacciale autoavvolgente per esterni con base in plastica nera riempibile ad acqua o sabbia, fissaggio grafica superiore tramite barra con chiusura a pinza, inferiore con biadesivo. Sacca compresa nel prezzo.

*Bifacial outdoor roll-up with black plastic base refillable with water or sand, upper fixing graphic through beam with pincers, lower with double-sided tape. Transport bag included with the price.*



## SCHEDA TECNICA

Codice art.	Grafica cm.	Imballo cm.	Peso Kg	Colore	L.P.
DWOUT80200	80x200	105x24x51	14.6	Black/Silver	390

# NEW OUTDOOR

Roll-up bifacciale autoavvolgente in alluminio silver con particolari cromati; dispone di molle per assorbire l'energia del vento, e può essere quindi collocato anche in esterno. Fissaggio grafica superiore tramite barra con chiusura a pinza, inferiore con biadesivo. Sacca compresa nel prezzo.

*Bifacial aluminium Roll-up with aluminium silver case with chromed parts; it has springs to absorb the wind energy so it can be positioned outdoor too. Upper fixing graphic through beam with pincers, lower with double-sided tape. Transport bag included with the price.*

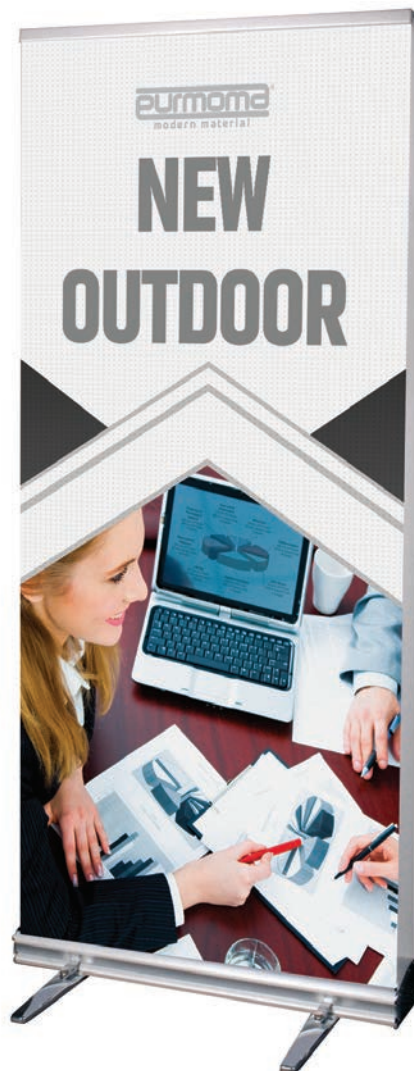
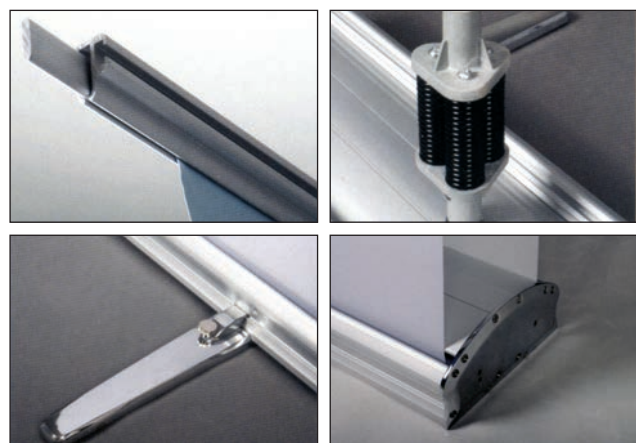

## SCHEDA TECNICA

Codice art.	Grafica cm.	Imballo cm.	Peso Kg	Colore	L.P.
UTROOU80200	80x200	25x15x90	14	Silver/Chrome	460
UTROOU100200	100x200	26x16.5x106	16.5	Silver/Chrome	520
UTROOU120200	120x200	28x17x127	20	Silver/Chrome	660

# STANDELLE

Struttura autoportante monofacciale/bifacciale in alluminio, con barre orizzontali con chiusura a pinza per banner, piedini regolabili. Sacca rigida compresa nel prezzo.

*Monofacial and bifacial vertical aluminium structure, with horizontal pincers latch rod for banner, adjustable bases. Bag included within the price.*

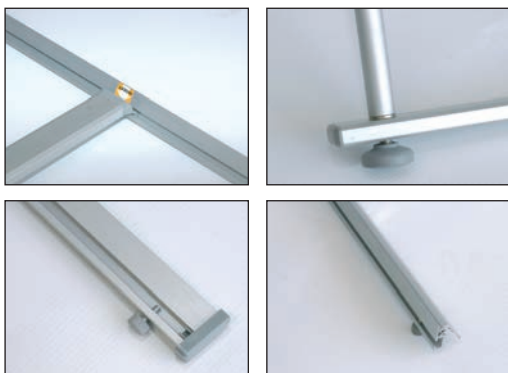

## BIFACCIALE



### SCHEDA TECNICA STANDELLE MONOFACCIALE

Codice art.	Misure esterne cm.	Grafica cm.	Imballo cm.	Peso Kg.	L.P.
DWSTAL60180	60x188	60x180	10x10x71	2.5	37
DWSTAL75200	75x208	75x200	10x10x77	3	45
DWSTAL80200	80x208	80x200	10x10x82	3	47
DWSTAL90200	90x208	90x200	10x10x92	3	50
DWSTAL100200	100x208	100x200	10x10x102	3.1	55
SPSTAL100220	100x220	100x215	10x10x102	3.1	55

### SCHEDA TECNICA STANDELLE BIFACCIALE

Codice art.	Misure esterne cm.	Grafica cm.	Imballo cm.	Peso Kg.	L.P.
DWDOSTAL9020	90x208	90x200	10x10x105	3.5	90
DWDOSTAL1020	100x208	100x200	10x10x102	3.8	100

# X BANNER

Struttura autoportante in fibra di vetro per banner; sacca di trasporto compresa nel prezzo.

*Banner vertical fiberglass aluminium structure; bag included with the price.*



ROLL - UP

60

## SCHEDA TECNICA

Codice art.	Misure esterne cm.	Grafica cm.	Imballo cm.	Peso Kg.	L.P.
WKXBA60160	60x160	60x160	4x6x108	1.2	12
WKXBA80180	80x180	80x180	4x6x108	1.3	15
WKXBA80200	80x200	80x200	4x6x108	1.5	18

# INTERCAMBIABILE MINI

Roll-up monofacciale in alluminio silver con particolari argento; fissaggio grafica superiore tramite barra con chiusura a pinza, inferiore con fasce adesive sfilabili per il cambio della grafica. Sacca compresa nel prezzo.

*Monofacial silver aluminium Roll-up, with silver details; upper graphic attachment through rod with pincers latch, lower with plastic tape to be extracted for the graphic change. Bag included with the price.*

FINO AD ESAURIMENTO



## SCHEDA TECNICA

Codice art.	Descrizione	Imballo cm.	Peso Kg.	Conf. pz.	Colore	L.P.
SPINMI85215	Roll-up intercambiabile cm. 85x215	18x11x91	4.1		Silver/Chrome	80
SPINMI100215	Roll-up intercambiabile cm. 100x215	18x11x106	4.2		Silver/Chrome	100
SPFA85	Fascia adesiva sfilabile cm. 85			10		20
SPFA100	Fascia adesiva sfilabile cm. 100			10		20

# SUPPORTI PER DISPLAY, ROLL-UP/POP-UP

## BANNER STOP-LIGHT

Supporto per il confezionamento di roll-up, fronte bianco con retro grigio; sottile, liscio da entrambe le superfici, ottimo grip per il biadesivo dell'avvolgitore, ottima stampabilità con inchiostri solvent, eco-solvent, UV. **No stampa Latex**

### SCHEDA TECNICA

Codice art.	Colore	Finitura	Spess.My	Dimensioni H cm	Rotolo L mt	L.P.
GPSL4209150	bianco	opaca	280	91	50	192
GPSL4201050	bianco	opaca	280	106	50	224
GPSL4201550	bianco	opaca	280	152	50	320



## KERNOW JET® ROLL-UP-POPUP

### POLIESTERE COMPOSTO RETRO GRIGIO PER ROLL-UP My 225

Nuovo supporto economico per roller da 225 my, finitura leggermente gofrata, non necessita di laminazione, superficie antistatica. Compromesso ideale tra prezzo e alta qualità.

### SCHEDA TECNICA

Codice art.	Colore	Finitura	Spess.My	Dimensioni H cm	Rotolo L mt	L.P.
KCSU2259130	bianco	gofrata	225	91.4	30	213



### POLIESTERE COMPOSTO RETRO GRIGIO PER ROLL-UP My 300

Nuovo supporto economico per roller da 300 my, finitura leggermente gofrata, non necessita di laminazione, superficie antistatica. Eccellente stabilità, compromesso ideale tra prezzo e alta qualità.

### SCHEDA TECNICA

Codice art.	Colore	Finitura	Spess.My	Dimensioni H cm	Rotolo L mt	L.P.
KCSU3001030	bianco	satinata	300	106.7	30	288
KCSU3001230	bianco	satinata	300	127	30	343
KCSU3001530	bianco	satinata	300	152.4	30	412



### FILM SINTETICO BIANCO My 210

Film sintetico bianco in polipropilene da 210 my, finitura satin, basso costo, occhiellabile, cucibile.

### SCHEDA TECNICA

Codice art.	Colore	Finitura	Spess.My	Dimensioni H cm	Rotolo L mt	L.P.
KCSINTPA9130	bianco	satinata	210	91.4	30	182
KCSINTPA1030	bianco	satinata	210	106.7	30	213
KCSINTPA1330	bianco	satinata	210	137.2	30	274
KCSINTPA1530	bianco	satinata	210	152.4	30	304



### POLIESTERE COMPOSTO RETRO GRIGIO PER POP-UP My 500

Nuovo supporto economico per roller da 500 my, finitura leggermente gofrata, non necessita di laminazione, superficie antistatica.

### SCHEDA TECNICA

Codice art.	Colore	Finitura	Spess.My	Dimensioni H cm	Rotolo L mt	L.P.
KCSU5009130	bianco	gofrata	500	91.4	30	422



### POLIESTERE BIANCO RETRO GRIGIO PER POP-UP My 290 FINITURA OPACA

Film in poliestere bianco retro grigio (stop-light) per pop-up, finitura opaca, ottima resistenza ai graffi, superficie antistatica.

### SCHEDA TECNICA

Codice art.	Colore	Finitura	Spess.My	Dimensioni H cm	Rotolo L mt	L.P.
KCPOPSLMA9130	bianco	opaca	290	91.4	30	556
KCPOPSLMA1230	bianco	opaca	290	127	30	772



### POLIESTERE BACKLIGHT My 215 OPACO

Supporto in poliestere traslucido, stampa fronte, finitura opaca, alta resistenza ai raggi UV, graffi, alto spessore.

### SCHEDA TECNICA

Codice art.	Colore	Finitura	Spess.My	Dimensioni H cm	Rotolo L mt	L.P.
KCBALIMA2151230	bianco	opaca	215	127	30	521
KCBALIMA2151530	bianco	opaca	215	152.4	30	625



### POLIESTERE BACKLIGHT My 200 LUCIDO

Supporto in poliestere traslucido, stampa fronte, finitura lucida, altissima risoluzione giorno e notte, alto spessore, rivestimento antigraffio.

### SCHEDA TECNICA

Codice art.	Colore	Finitura	Spess.My	Dimensioni H cm	Rotolo L mt	L.P.
KCBALIGL2001030	bianco	lucida	200	106.7	30	398
KCBALIGL2001330	bianco	lucida	200	137.2	30	512
KCBALIGL2001530	bianco	lucida	200	152.4	30	569



**POLIESTERE PER GRAFICHE CALPESTABILI SU PAVIMENTI**

Supporto in poliestere, spessore 200 my, estremamente resistente per grafiche calpestabile su pavimenti lisci con adesivo removibile. Certificato R10, non necessità di laminazione.

**SCHEDA TECNICA**

Codice art.	Colore	Finitura	Spess.My	Dimensioni H cm	Rotolo L mt	L.P.
KCSHARK1701325	bianco	strutturato	200	137.2	25	684
KCSHARK1701525	bianco	strutturato	200	152.4	25	761

**POLIESTERE BIANCO SATINATO ADESIVO REMOVIBILE MY 130**

Supporto in poliestere bianco con adesivo a microsfere per una facile applicazione, collante removibile.

**SCHEDA TECNICA**

Codice art.	Colore	Finitura	Spess.My	Dimensioni H cm	Rotolo L mt	L.P.
KCADRE139130	bianco	satinata	130	91.4	30	294
KCADRE131330	bianco	satinata	130	137.2	30	442

**POLIESTERE TRASPARENTE LUCIDO**

Supporto in poliestere trasparente, spessore 142 my, alta stabilità e resistenza al calore, supporto antistatico.

**SCHEDA TECNICA**

Codice art.	Colore	Finitura	Spess.My	Dimensioni H cm	Rotolo L mt	L.P.
KCPETCL1330	trasparente	lucida	142	137.2	30	442
KCPETCL1530	trasparente	lucida	142	152.4	30	491

**POLIESTERE NERO PER STAMPA UV My 195**

Supporto in poliestere nero Ideale per stampa con inchiostri bianchi.

**SCHEDA TECNICA**

Codice art.	Colore	Finitura	Spess.My	Dimensioni H cm	Rotolo L mt	L.P.
KCPETNE9130	nero	goffrata	195	91.4	30	308
KCPETNE1230	nero	goffrata	195	127.0	30	428
KCPETNE1530	nero	goffrata	195	152.4	30	514

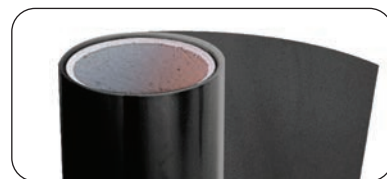
**POLIESTERE BIANCO STAMPA BIFACCIALE**

Supporto in poliestere stampabile su entrambi i lati, finitura opaca, spessore 195 my, rapida asciugatura, ottima resistenza all'abrasione.

**SCHEDA TECNICA**

Codice art.	Colore	Finitura	Spess.My	Dimensioni H cm	Rotolo L mt	L.P.
KCPETMA9130D	bianco	opaca	195	91.4	30	470
KCPETMA1230D	bianco	opaca	195	127	30	680

**POLIESTERE ARGENTO SPECCHIO**

Poliestere finitura a specchio, spessore 119 my, superficie antistatica, ottimo risultato cromatico.

**SCHEDA TECNICA**

Codice art.	Colore	Finitura	Spess.My	Dimensioni H cm	Rotolo L mt	L.P.
KCPETMIR1230	argento	lucida	119	127	30	520

**SUPPORTI SPECIALI BASE ACQUA****POLIESTERE BIANCO MATT RETRO GRIGIO STOP-LIGHT My 185**

Supporto in poliestere economico, ideale per roll-up, finitura matt, compatibile anche con inchiostri LATEX.

**SCHEDA TECNICA**

Codice art.	Colore	Finitura	Spess.My	Dimensioni H cm	Rotolo L mt	L.P.
KCSLPIG1859130	Bianco	Opaca	185	91.4	30	303
KCSLPIG1851030	Bianco	Opaca	185	106.7	30	354
KCSLPIG1851230	Bianco	Opaca	185	127	30	421

**POLIESTERE BIANCO MATT RETRO GRIGIO STOP LIGHT My 310**

Film in poliestere bianco opaco retro grigio stop-light, per pop-up.

**SCHEDA TECNICA**

Codice art.	Colore	Finitura	Spess.My	Dimensioni H cm	Rotolo L mt	L.P.
KCSLPIG3109120	bianco	Opaca	310	91.4	20	372





# TOTEM

TOTEM ARIANNA STYLE  
NEW BIG TOTEM DA ESTERNO  
NEW BIG TOTEM  
SISTEMA ALICE  
EXPO ALICE  
TOTEM LUMINOSO  
TOTEM PIUMA  
NEW ONDA TOTEM  
ONDA INFO  
TOTEM QUADRO & ELLISSE  
TOTEM ALLUMINIO  
TOTEM PRISMA  
TOTEM PRISMA QUADRO  
TOTEM TRIS  
TOTEM KARTOON

# TOTEM ARIANNA STYLE

Totem autoportante realizzato con profili in alluminio di spessore mm. 18. Dal design elegante e minimale, da quest'anno si rinnova completamente con finiture estetiche inedite, diventando anche più economico. Leggero e resistente, si distingue per l'estetica raffinata e la struttura solida, interamente assemblata a mano presso i nostri reparti di produzione, che su richiesta e per determinati quantitativi realizzano anche formati su misura.

*Totem-standing, made of aluminum profiles mm. thick 18. Minimal and elegant design, it is now completely renewed with other aesthetic finishes, becoming also cheaper. Light and strong, has a stable and refined structure, wholly hand assembled in our production departments, that also realize tailored sizes on request.*

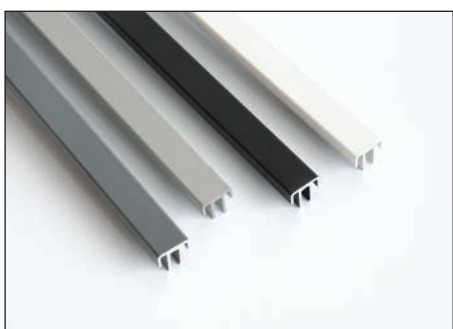
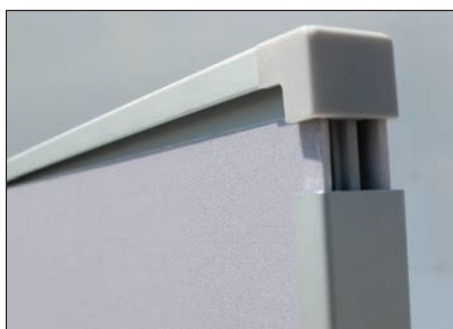

Alta qualità e design raffinato per il miglior totem di sempre, disponibile da ora in tante diverse finiture!



CORNICE NERA



CORNICE BIANCA



CORNICE GRIGIA

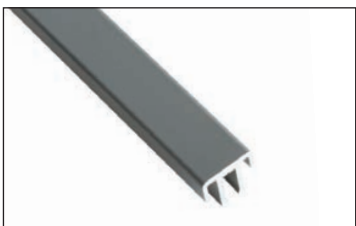

CORNICE ARGENTO ANODIZZATO



**TOTEM ARIANNA STYLE NERO**

Codice art.	Dimens. est. cm	Grafica cm	L.P.
EUTAS50140N	50,5x142,5	49,9x132,2	260
EUTAS50160N	50,5x161	49,9x151,1	280
EUTAS50180N	50,5x177,5	49,9x167,3	300
EUTAS50200N	50,5x192,2	49,9x182,3	320
EUTAS60140N	60,5x142,5	59,9x132,2	280
EUTAS60160N	60,9x161	59,9x151,1	300
EUTAS60180N	60,5x177,5	59,9x167,3	330
EUTAS60200N	60,5x192,2	59,9x182,3	350
EUTAS70140N	70,5x142,5	69,9x132,2	300
EUTAS70160N	70,5x161	69,9x151,1	320
EUTAS70180N	70,5x177,5	69,9x167,3	350
EUTAS70200N	70,5x192,2	69,9x182,3	370

**TOTEM ARIANNA STYLE BIANCO**

Codice art.	Dimens. est. cm	Grafica cm	L.P.
EUTAS50140B	50,5x142,5	49,9x132,2	260
EUTAS50160B	50,5x161	49,9x151,1	280
EUTAS50180B	50,5x177,5	49,9x167,3	300
EUTAS50200B	50,5x192,2	49,9x182,3	320
EUTAS60140B	60,5x142,5	59,9x132,2	280
EUTAS60160B	60,9x161	59,9x151,1	300
EUTAS60180B	60,5x177,5	59,9x167,3	330
EUTAS60200B	60,5x192,2	59,9x182,3	350
EUTAS70140B	70,5x142,5	69,9x132,2	300
EUTAS70160B	70,5x161	69,9x151,1	320
EUTAS70180B	70,5x177,5	69,9x167,3	350
EUTAS70200B	70,5x192,2	69,9x182,3	370

**TOTEM ARIANNA STYLE GRIGIO**

Codice art.	Dimens. est. cm	Grafica cm	L.P.
EUTAS50140G	50,5x142,5	49,9x132,2	260
EUTAS50160G	50,5x161	49,9x151,1	280
EUTAS50180G	50,5x177,5	49,9x167,3	300
EUTAS50200G	50,5x192,2	49,9x182,3	320
EUTAS60140G	60,5x142,5	59,9x132,2	280
EUTAS60160G	60,9x161	59,9x151,1	300
EUTAS60180G	60,5x177,5	59,9x167,3	330
EUTAS60200G	60,5x192,2	59,9x182,3	350
EUTAS70140G	70,5x142,5	69,9x132,2	300
EUTAS70160G	70,5x161	69,9x151,1	320
EUTAS70180G	70,5x177,5	69,9x167,3	350
EUTAS70200G	70,5x192,2	69,9x182,3	370

**TOTEM ARIANNA STYLE ARGENTO ANODIZZATO**

Codice art.	Dimens. est. cm	Grafica cm	L.P.
EUTAS50140S	50,5x142,5	49,9x132,2	260
EUTAS50160S	50,5x161	49,9x151,1	280
EUTAS50180S	50,5x177,5	49,9x167,3	300
EUTAS50200S	50,5x192,2	49,9x182,3	320
EUTAS60140S	60,5x142,5	59,9x132,2	280
EUTAS60160S	60,9x161	59,9x151,1	300
EUTAS60180S	60,5x177,5	59,9x167,3	330
EUTAS60200S	60,5x192,2	59,9x182,3	350
EUTAS70140S	70,5x142,5	69,9x132,2	300
EUTAS70160S	70,5x161	69,9x151,1	320
EUTAS70180S	70,5x177,5	69,9x167,3	350
EUTAS70200S	70,5x192,2	69,9x182,3	370

# NEW BIG TOTEM PER ESTERNO

Totem da esterno a sezione ellittica bifacciale, non luminoso, composto da una pesante base in ferro ancorata a profilati estrusi in alluminio con pannelli in PVC spessore mm. 3 e provvisto di tappo superiore. È OBBLIGATORIO il fissaggio a terra.

Outdoor bifacial totem with elliptical section, not bright, composed of heavy iron base fixed to extruded aluminum profiles with PVC panels 3 mm. thickness and provided with top cap. OBLIGATORY the ground fixing.

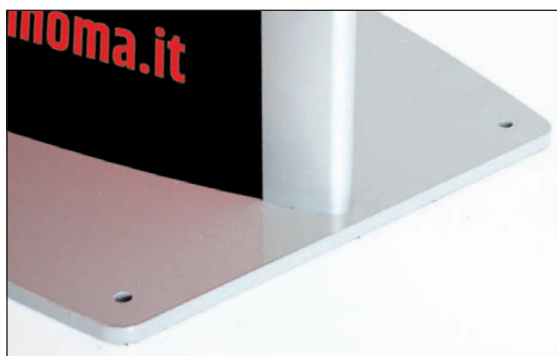

Fori per fissaggio a terra

## SCHEDA TECNICA

Codice art.	Pannello cm.	Dim. est. cm.	Dim. base cm.	Colore base	L.P.
EUNAWBT820E	77,5x200	80x200	83x48	Grigia	800
EUNAWBT850E	77,5x250	80x250	83x48	Grigia	850
EUNAWBT830E	77,5x300	80x300	83x48	Grigia	900
EUNAWBT120E	99,5x200	100x200	103x48	Grigia	1000
EUNAWBT125E	99,5x250	100x250	103x48	Grigia	1050
EUNAWBT130E	99,5x300	100x300	103x48	Grigia	1100

# NEW BIG TOTEM

Totem a sezione ellittica bifacciale non luminoso, composto da base in PVC-HD, profilati estrusi in alluminio e pannelli in PVC da mm 3 di diverse dimensioni. NUOVE MISURE GIGANTI.

*Totem elliptical section bifacial not bright, composed of PVC - HD base, extruded aluminum profiles and PVC panels, from 3 mm of different sizes. NEW MEASURES GIANTS.*



# Gigante cm 250-300

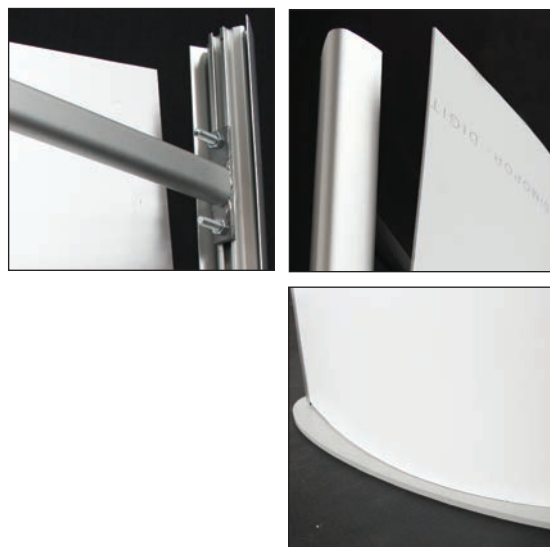

## SCHEDA TECNICA

Codice art.	Pannello cm.	Dim. cm.	Colore base	L.P.
EUNWBT620N	57x200	60x200	Nera	400
EUNWBT820N	77,5x200	80x200	Nera	450
EUNWBT1020N	99,5x200	100x200	Nera	500
EUNWBT1225N	120x250	120x250	Nera	600
EUNWBT1230N	120x300	120x300	Nera	650
EUNWBT620G	57x200	60x200	Grigia	400
EUNWBT820G	77,5x200	80x200	Grigia	450
EUNWBT1020G	99,5x200	100x200	Grigia	500
EUNWBT1225G	120x250	120x250	Grigia	600
EUNWBT1230G	120x300	120x300	Grigia	650

# SISTEMA ALICE

Sistema di connettori in alluminio anodizzato per il fissaggio modulare di lastre in plastica da un minimo di mm. 5 ad un massimo di mm. 8 per lo Standard e da mm. 10 a mm. 16 per il Maxi. Il montaggio tramite cacciavite a brugola è molto semplice.

*A connector system for fixing anodized aluminum modular plastic sheets from a minimum of mm. 5 To a maximum of mm. 8 for the Standard and from mm. 10 to mm. 16 for the Maxi. The assembly through the allen key is very simple.*



**Cod. IR20101** L.P. 20  
Connettore angolo variabile 90°/270° Spessore lastra da mm.5 a mm.8



**Cod. IR20107** L.P. 32  
Connettore multifunzioni angolo variabile 0°/360° Spessore lastra da mm.5 a mm.8



**Cod. IR29101** L.P. 24  
Connettore angolo variabile 90°/270°. Spessore lastra da mm.5 a mm.8



**Cod. IR20103** L.P. 26  
Connettore angolo variabile 90°/270° Snap a pressione. Spessore lastra da mm.5 a mm.8

**Cod. IR20301** L.P. 34  
Spessore lastra da mm.10 a mm.16

**Cod. IR20307** L.P. 43  
Spessore lastra da mm.10 a mm.16



**Cod. IR00105** L.P. 14  
Connettore fisso per due pezzi aggancio. Spessore lastra da mm. 5 a mm.8



**Cod. IR20100** L.P. 16  
Connettore fisso angolo 90°. Spessore lastra da mm. 5 a mm. 8



**Cod. IR00109** L.P. 14  
Connettore finale oppure a muro. Spessore lastra da mm. 5 a mm.8



**Cod. IR09105** L.P. 14  
Connettore fisso. Spessore lastra da mm.5 a mm.8

**Cod. IR00309** L.P. 18  
Connettore finale oppure a muro. Spessore lastra da mm. 10 a mm. 16



**Cod. IR20108** L.P. 24  
Connettore tre lati a 90° fissi. Spessore lastra da mm.5 a mm.8



**Cod. IR20105** L.P. 34  
Connettore a croce Spessore lastra da mm.5 a mm.8



**Cod. IR20106** L.P. 28  
Connettore tre lati variabili Spessore lastra da mm.5 a mm.8



**Cod. IR20110** L.P. 32  
Connettore verticale orizzontale. Spessore lastra da mm.5 a mm.8



**Cod. IR10003** L.P. 24  
Viti senza testa in acciaio piccole Scatola 50 pezzi

**Cod. IR10303** L.P. 38  
Viti senza testa in acciaio grandi Scatola 50 pezzi



**Cod. IR11999** L.P. 14  
Cacciavite a brugola per viti grandi

**Cod. IR10999** L.P. 12  
Cacciavite a brugola per viti piccole

# EXPO ALICE

Palo in alluminio anodizzato con alette per il fissaggio dei connettori Standard (da mm. 5 a mm. 8) del Sistema Alice. Altezza mt. 2, base disponibile sia in metallo che in PVC HD.

*Anodized aluminum pole with lugs for fixing the connectors in Standard Range (from mm. 5 to mm. 8) of the Alice System. Height mt. 2, base available bot in metal and PVC HD.*



**SEZIONE PALO**  
(SOLO PER CONNETTORI mm 5/8)

Cod. Art.	Descrizione	L.P.
IRPALO	Palo in alluminio da mt. 2 a 4 ancoraggi	100
IRBASE	Base circolare in metallo	40
EUBASEALI	Base quadra in PVC HD cm. 32 x32	40
IRPUNT	Puntale conico fine palo	24

BASE QUADRA PVC HD

BASE CIRCOLARE METALLO



## CONNETTORE ALICE PER TARGHE A BANDIERA

### SCHEDA TECNICA

Codice articolo	Descrizione	Spessore pannello	L.P./Cad
IR00109	Connettore a muro da mm.33	Da mm. 5 a mm. 8	14
IR00110	Connettore a muro da mm.66	Da mm. 5 a mm. 8	28
IR00111	Connettore a muro da mm.99	Da mm. 5 a mm. 8	34

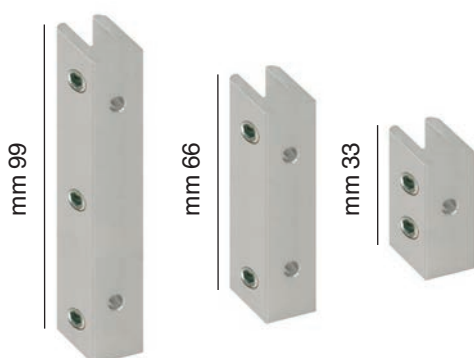

# TOTEM LUMINOSO

Totem con impianto interno luminoso, con pratiche cornici a scatto per un rapido cambio della grafica. È dotato di apposita areazione, e di certificazione CE/UL PAT. Nella dotazione è compreso un cavo con presa elettrica da 2 metri.

*Totem with bright inside plant, with practical snap frames for quick changing of graphics. It is equipped with a special ventilation, and CE / UL PAT certification. In the equipment is included a cable with 2 meters wall socket.*

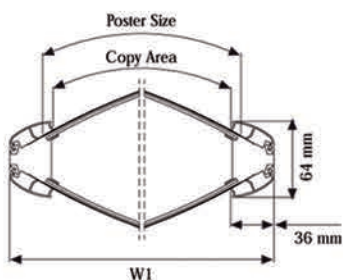
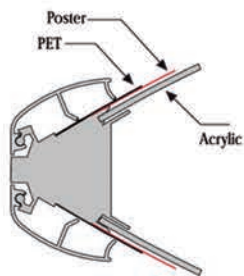
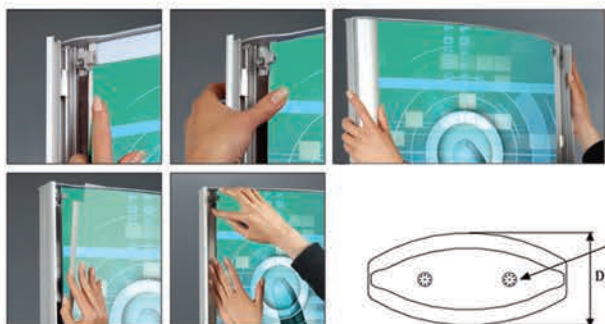
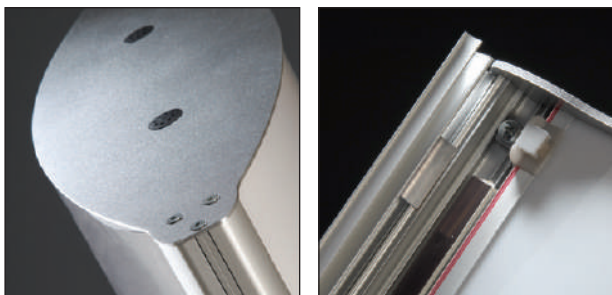

cm 65/75/85

cm 172

## SCHEDA TECNICA

Codice art.	Dim. cm.	Dim. grafica cm.	Colore base	L.P.
MTTOLU60170	65x172	60x170	Silver	590
MTTOLU70170	75x172	70x170	Silver	652
MTTOLU80170	85x172	80x170	Silver	800



# TOTEM PIUMA

Pratico e leggero totem da interno, può essere sia monofacciale che bifacciale; a richiesta è disponibile anche in altri formati per determinate quantità.  
DISPONIBILE ANCHE IN VERSIONE GIGANTE.

*Practical and light interior totems, which can be either single-sided; on demand it is also available in other formats for certain quantities. AVAILABLE IN GIANT VERSION TOO.*

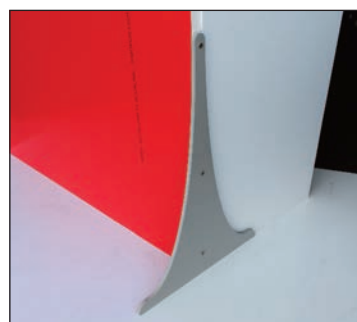
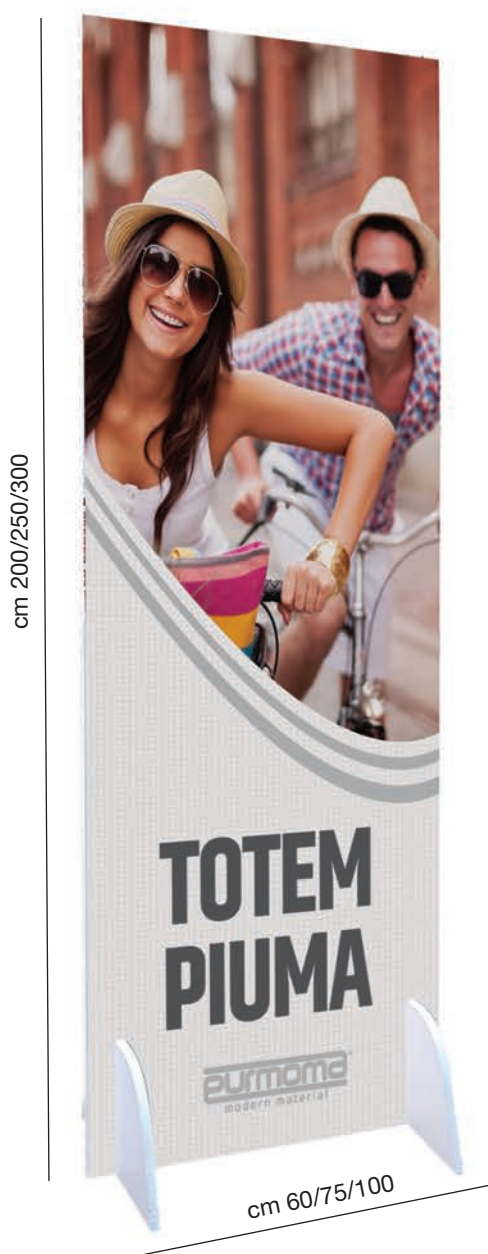

## SCHEMA TECNICA

Codice art.	Dim. grafica cm.	Peso Kg.	Spessore mm.	L.P.
EUTOTPIU620	60x200	2.6	15	110
EUTOTPIU7520	75x200	3.1	15	138
EUTOTPIU1020	100x200	4.3	15	176
EUTOTPIU1025	100x250	6.5	30	250
EUTOTPIU1030	100x300	7.8	30	300

# NEW ONDA TOTEM

Totem bifacciale di sezione ellittica, da interno, realizzato in polionda bianco.

*Totem sided elliptical section, indoor, made of white corrugated material.*



cm 200



## SCHEMA TECNICA

Codice art.	Dim. esterne cm.	Dim. grafica cm.	L.P.
EUNOT620	67x200	67x199	72
EUNOT1020	100x200	101x199	120
EUNOT1320	130x200	135x199	190

TOTEM

72

# ONDA INFO

Totem bifacciale in polionda bianco, con sezione ellittica e finale piano, per ospitare tasche portabrochure.

*Bi-sided Totem corrugated material in white, with elliptical section and the final plan, to accommodate pockets brochure.*



cm 199,5



cm 123,5/154

## SCHEMA TECNICA

Codice art.	Dim. esterne cm.	Dim. grafica cm.	L.P.
EUOI1033	123,5x199,5	101(+34)x199,5	170
EUOI1063	154x199,5	101(+64,5)x199,5	170

# TOTEM QUADRO E ELLISSE

Strutture autoportanti in polionda bianco di grandi dimensioni. Vengono fornite smontate in kit per facilitarne il trasporto, mentre l'assemblaggio è molto semplice tramite il biadesivo in dotazione.

TOTEM QUADRO ANCHE IN VERSIONE GIGANTE.

*Self-supporting structures in white corrugated material large. They are supplied disassembled in kit for easy transportation, while the assembly is very simple using the supplied double-sided adhesive.*

*TOTEM QUADRO ALSO IN GIANT VERSION.*

## TOTEM ELLISSE

Codice art.	Dimensione		L.P.
	Esterne cm.	Grafica cm.	
EUTOTEL1520	140x200	140x200	180

## TOTEM QUADRO

Codice art.	Dimensione		L.P.
	Esterne cm.	Grafica cm.	
EUTOTQUA1020	98x200	98x200	192
EUTOTQUA7525	74x245	74x245	200
EUTOTQUA10025	99x245	99x245	250



cm 245

cm 200

Gigante cm 245

TOTEM

73

# TOTEM ALLUMINIO

Totem in alluminio anodizzato argento, leggero e facile da montare; ospita un pannello in pvc espanso di spessore mm 5, e si può utilizzare sia in versione monofacciale che bifacciale. Su richiesta è possibile averlo in formati personalizzati.

*Silver anodized aluminum totem, lightweight and easy to assemble; it hosts a PVC panel foam 5 mm thickness, and it can be used in both single-sided and double-sided. On request it can be have it in custom sizes.*

## SCHEMA TECNICA

Codice art.	Dim. esterne cm.	Tipol. piede	Dim. piede cm.	L.P.
EUTOTAL620SC	65x205	Eurobond	42	194
EUTOTAL720SC	75x205	Eurobond	42	204
EUTOTAL820SC	85x205	Eurobond	42	216
EUTOTAL1020SC	105x205	Eurobond	42	230
EUTOTAL1520SC	155x205	Eurobond	42	310
EUTOTAL620PX	65x205	Perspex	50	194
EUTOTAL720PX	75x205	Perspex	50	204
EUTOTAL820PX	85x205	Perspex	50	216
EUTOTAL1020PX	105x205	Perspex	50	230
EUTOTAL1520PX	155x205	Perspex	50	310
EUTOTAL620TU	65x205	Tubo quadro	50	194
EUTOTAL720TU	75x205	Tubo quadro	50	204
EUTOTAL820TU	85x205	Tubo quadro	50	216
EUTOTAL1020TU	105x205	Tubo quadro	50	230
EUTOTAL1520TU	155x205	Tubo quadro	50	310
EUTOTAL620MZ	65x205	Mezzaluna	42	194
EUTOTAL720MZ	75x205	Mezzaluna	42	204
EUTOTAL820MZ	85x205	Mezzaluna	42	216
EUTOTAL1020MZ	105x205	Mezzaluna	42	230
EUTOTAL1520MZ	155x205	Mezzaluna	42	310

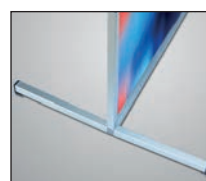

PIEDE TUBO QUADRO



PIEDE PERSPEX

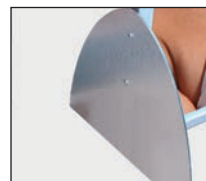

PIEDE EUROBOND

cm 200



cm 65/75/84/105/155

# TOTEM PRISMA

Totem leggero in polionda bianco, composto da tre prismi a base triangolare posti l'uno sull'altro ed innestati tramite incastrati. Viene fornito in kit per facilitare il trasporto ed il montaggio. DISPONIBILE ANCHE IN VERSIONE GIGANTE.

*Totem light in white corrugated material, composed of three triangular base prisms placed on one another and grafted through joints. It is supplied in kits to facilitate transport and assembly. AVAILABLE ALSO IN GIANT VERSION.*

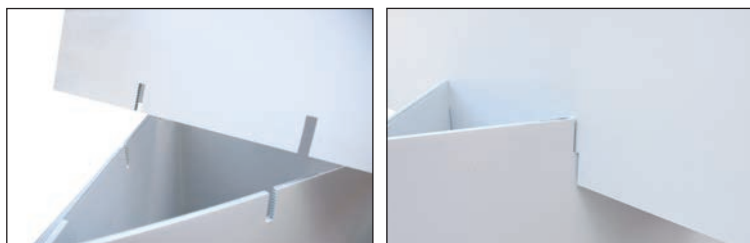

## SCHEDA TECNICA

Codice art.	Dimensioni			
	Esterne cm.	Grafica cm.	Altezza tot. cm.	L.P.
EUTOTPRI350	50x66 x tre lati	50x66 x tre lati	200	84
EUTOTPRI366	66x66 x tre lati	66x66 x tre lati	200	108
EUTOTPRI3100	99x66 x tre lati	99x66 x tre lati	200	168
EUTOTPRI31030	99x99 x tre lati	99x99 x tre lati	300	250
SNSACCA	Sacca in tessuto XXL solo per versione cm. 50 x 66			50



cm 200



# TOTEM PRISMA QUADRO

Totem leggero in polionda bianco, composto da tre moduli a base quadra posti l'uno sull'altro ed innestati tramite incastrati. Viene fornito in kit per facilitare il trasporto ed il montaggio. DISPONIBILE ANCHE IN VERSIONE GIGANTE.

*Totem light in white corrugated material, consists of three modules based square top of each other and grafted through joints. It is supplied in kits to facilitate transport and assembly. AVAILABLE ALSO IN GIANT VERSION.*



## SCHEDA TECNICA

Codice art.	Dimensioni			
	Esterne cm.	Grafica cm.	Altezza tot. cm.	L.P.
EUTOTPRI450	49x66 x quattro lati	49x66 x quattro lati	200	108
EUTOTPRI475	74x66 x quattro lati	74x66 x quattro lati	200	144
EUTOTPRI41030	99x99 x quattro lati	99x99 x quattro lati	300	300

cm 200



# TOTEM TRIS

Totem in polionda bianco, viene fornito in kit, aperto e smontato per facilitare l'applicazione delle grafiche. Optional le tasche trasparenti, su richiesta è disponibile anche in altre misure, per determinati quantitativi. DISPONIBILE ANCHE IN VERSIONE GIGANTE COME DA FOTO.

*Totem in white corrugated material, it is supplied in kit, open and disassembled to facilitate the application of the graphics.*

*Optional transparent pockets, on demand is also available in other sizes, for certain quantities. AVAILABLE ALSO IN GIANT AS PER PHOTO.*

# Gigante cm 245



cm 200



## SCHEDA TECNICA

Codice art.	Dim. esterne cm.	Dim. grafica cm.	L.P.
EUTOTTRIS50	49x200 x tre lati	49x200 x tre lati	66
EUTOTTRIS66	66x200 x tre lati	66x200 x tre lati	83
EUTOTTRIS100	98x200 x tre lati	98x200 x tre lati	132
EUTOTTRIS1025	99x245 x tre lati	99x245 x tre lati	200

# TOTEM KARTOON

Totem da interno in kartoon ecologico, sia bifacciale che monofacciale; a richiesta è disponibile anche in altri formati per determinate quantità.

*Inner Totem in ecological kartoon, single and double-sided; on demand it is also available in other formats for certain quantities.*

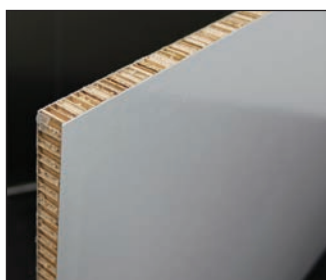
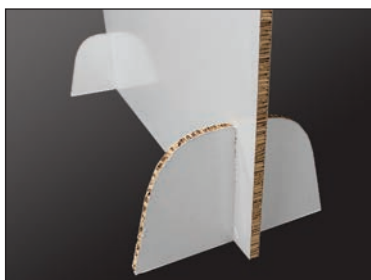
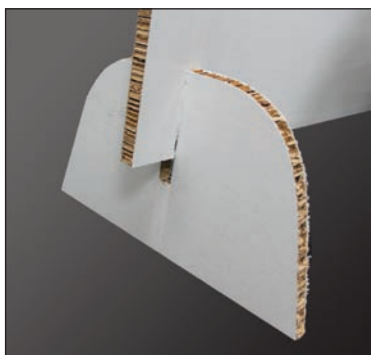
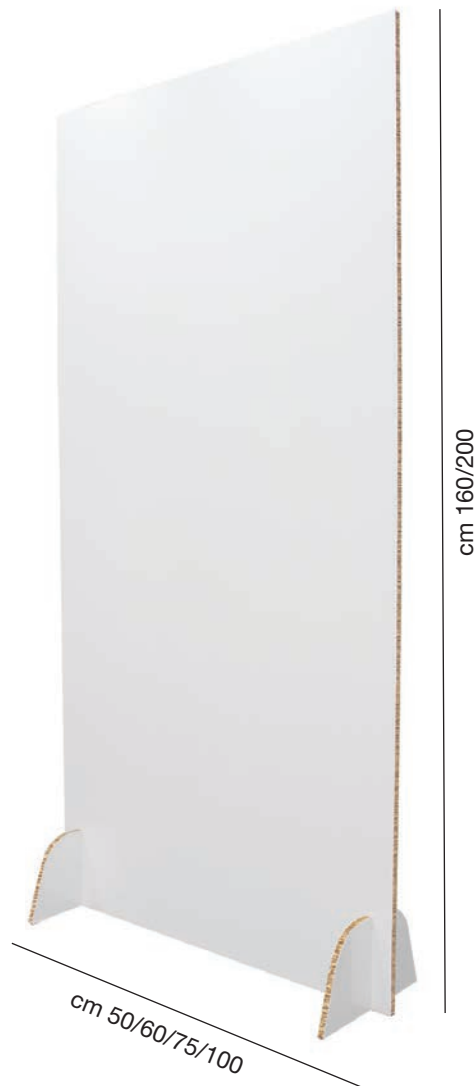

## SCHEDA TECNICA

Codice art.	Dim. grafica cm.	Peso Kg.	Spessore mm.	L.P.
EUTOKART50160	50x160	1,90	16	72
EUTOKART60160	60x160	2,30	16	87
EUTOKART75160	75x160	2,80	16	108
EUTOKART100160	100x160	3,80	16	144
EUTOKART60200	60x200	3	16	110
EUTOKART75200	75x200	3,5	16	138
EUTOKART100200	100x200	4,7	16	176

# CORNICI

OPTI KLIK-KLAK  
ECO KLIK-KLAK  
KLIK-KLAK  
CORNICE SLIDE  
WINDOWS FRAME  
KLIK-KLAK GLASS  
CORNICI ALUSTYLE  
CORNICI A SCOMPARSA  
CORNICI ALUFRAME  
POSTER SNAP  
POSTER CLAMP  
STRECH FRAME  
EXPOFRAME  
LAVAGNA PERSPEX

MAGNETIC LIGHTBOX  
BACHECA NOTES/LED  
BACHECA  
BACHECA PLUS  
BANNER BOX 60/125  
CORNICI TEXTILE  
ECO LEDBOX  
LITE LEDBOX  
LITE LEDBOX OUTDOOR  
SLIM LEDBOX  
MAGNETO LEDBOX  
MOONLIGHT LEDBOX  
MOONLIGHT MAGNETO LED

# OPTI KLIK KLAK

KLIK KLAK®

Cornice klik klak con angolo a 45°, si monta in modo intuitivo a parete grazie ai ganci di cui è dotata. Per i formati più piccoli A5 e A6 è possibile avere anche il supporto da tavolo; è disponibile con un quantitativo minimo di 10 pezzi.

Ora disponibili i fogli di ricambio antiriflesso.

*Klik Klak frame with a 45° angle, is mounted in an intuitive way to the wall thanks to the hooks supplied with it. For smaller sizes A5 and A6 it can also have the support table; it is available with a minimum quantity of 10 pieces.*

*Now available replacement anti-reflection sheets.*





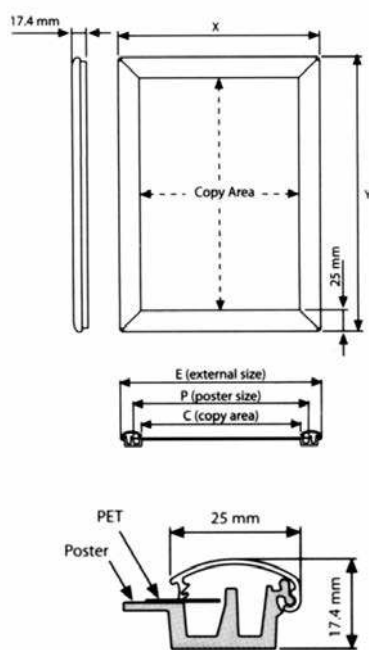
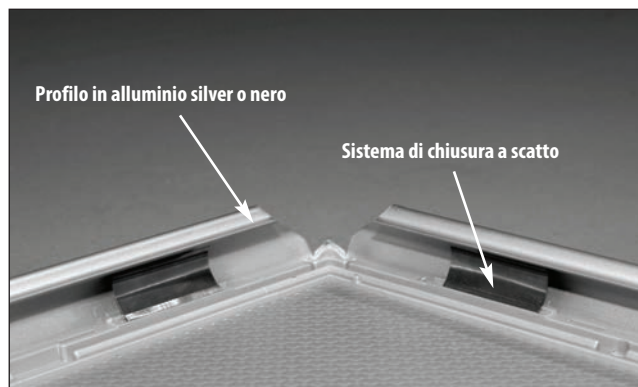

### FOGLI ANTIRIFLESSO DI RICAMBIO

Codice art.	Descrizione	Formato cm.	Spess. my	LP
KKPVM303550	Antiriflesso 300	35x50	300	1,50
KKPVM305070	Antiriflesso 300	50x70	300	3
KKPVM307010	Antiriflesso 300	70x100	300	6
KKPVM501014	Antiriflesso 500	100x140	500	19

### SCHEDA TECNICA

Codice art.	Colore	Dim. cm.	Dim. grafica cm.	Imballo cm.	Peso Kg.	L.P.
MTOPTSA6	Silver	12,6x16,9	10,5x14,8	13,5x18x2	0.15	5,70
MTOPTSA5	Silver	16,9x23,1	14,8x21	18x24x2	0.26	6,90
MTOPTSA4	Silver	24,1x32,8	21x29,7	25x34x2	0.50	9,40
MTOPTSA3	Silver	32,7x45	29,7x42	34x46x2	0.85	13,70
MTOPTSA2	Silver	45,0x62,4	42x59,4	47x64x2	1.23	22,70
MTOPTSB2	Silver	53x73	50x70	54,5x74x2	1.50	26,30
MTOPTYNA6	Nera	12,6x16,9	10,5x14,8	13,5x18x2	0.15	5,80
MTOPTYNA5	Nera	16,9x23,1	14,8x21	18x24x2	0.26	7,30
MTOPTYNA4	Nera	24,1x32,8	21x29,7	25x34x2	0.50	12,50
MTOPTYNA3	Nera	32,7x45	29,7x42	34x46x2	0.85	18,90
MTOPTYNA2	Nera	45x62,4	42x59,4	47x64x2	1.23	30,80
MTOPTYNB2	Nera	53x73	50x70	54,5x74x2	1.50	31,50

Cornice klik-klak con profilo da mm 25 in alluminio Silver, angolo a 45° oppure rotondo cromato; è presente il foglio in PVC antiriflesso per la protezione delle immagini. Fissaggi al muro compresi nel prezzo.

Ora disponibili i fogli di ricambio antiriflesso.

*Klik - Klak frame with profile of 25 mm aluminum Silver, 45° angle or round chromed; It is included the antireflection PVC sheet for image protection. Fixing to the wall included within the price.*

*Now availables replacement anti-reflection sheets.*

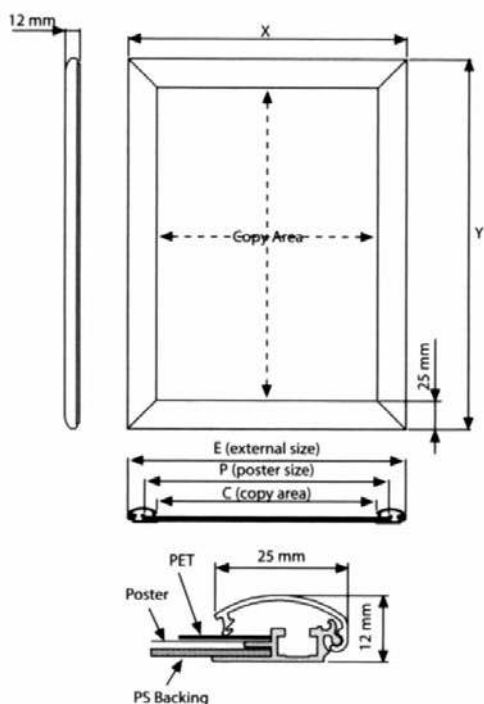

ANGOLO TONDO CROMATO



ANGOLO A 45°

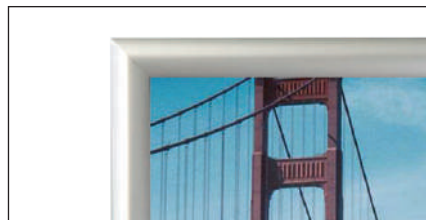

## FOGLI ANTIRIFLESSO DI RICAMBIO

Codice art.	Descrizione	Formato cm.	Spess. my	LP
KKPVM303550	Antiriflesso 300	35x50	300	1,50
KKPVM305070	Antiriflesso 300	50x70	300	3
KKPVM307010	Antiriflesso 300	70x100	300	6
KKPVM501014	Antiriflesso 500	100x140	500	19

## SCHEDE TECNICA

Codice art.	Colore	Dim. cm.	Poster cm.	Angolo	Peso Kg.	L.P.
MTECOKKSB245	Silver	53x73	50x70	45°	1.65	35
MTECOKKSB145	Silver	73x103	70x100	45°	2.9	55
MTECOKKSB045	Silver	103x143	100x140	45°	6	92
MTECOKKSB2AT	Silver	53x73	50x70	Tondo	1.65	35
MTECOKKSB1AT	Silver	73x103	70x100	Tondo	2.9	55
MTECOKKSB0AT	Silver	103x143	100x140	Tondo	6	92

# ECO KLIK KLAK

## NERO - CROMO - ACCIAIO

# KLIK KLAK®

Cornice klik-klak con profilo da 25 mm. in alluminio disponibile in diverse colorazioni, angolo a 45°; è presente il foglio in PVC antiriflesso per la protezione delle immagini. Fissaggi al muro compresi nel prezzo. Ora disponibili i fogli di ricambio antiriflesso.

*Klik Klak frame with profile from mm. 25, aluminum available in different colors, 45 ° angle; it is included the antireflection PVC sheet for image protection. Fixing to the wall included within the price. Now availables replacement anti-reflection sheets.*

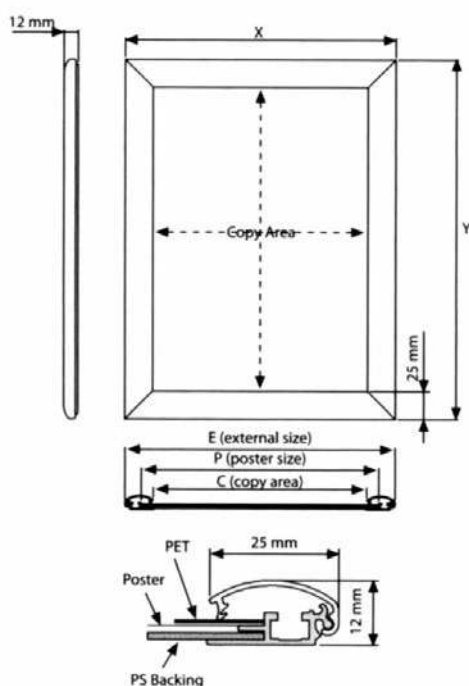

### FOGLI ANTIRIFLESSO DI RICAMBIO

Codice art.	Descrizione	Formato cm.	Spess. my	LP
KKPVM303550	Antiriflesso 300	35x50	300	1,50
KKPVM305070	Antiriflesso 300	50x70	300	3
KKPVM307010	Antiriflesso 300	70x100	300	6
KKPVM501014	Antiriflesso 500	100x140	500	19

### SCHEMA TECNICA

Codice art.	Colore	Dim. cm.	Poster cm.	Angolo	Peso Kg.	L.P.
MTECOKKCB245	Cromo	53x73	50x70	45°	1.6	67
MTECOKKCB145	Cromo	73x103	70x100	45°	2.3	110
MTECOKKCB045	Cromo	103x143	100x140	45°	6	170
MTECOKKNB245	Nero	53x73	50x70	45°	1.6	48
MTECOKKNB145	Nero	73x103	70x100	45°	2.3	77
MTECOKKNB045	Nero	103x143	100x140	45°	6	122
MTECOKKAB245	Acciaio	53x73	50x70	45°	1.6	50
MTECOKKAB145	Acciaio	73x103	70x100	45°	2.3	78
MTECOKKAB045	Acciaio	103x143	100x140	45°	6	124

# ECO KLIK KLAK

## ANTI EFFRAZIONE

Speciale cornice klik klak con profilo di sicurezza da mm. 25, angolo a 45°, sbloccabile soltanto con apposita chiave, fornita in dotazione. Ora disponibili i fogli di ricambio antiriflesso.

*Special frame klik klak with safety profile from mm. 25, 45° angle, unlockable only by special tool, provided. Now availables replacement anti-reflection sheets.*

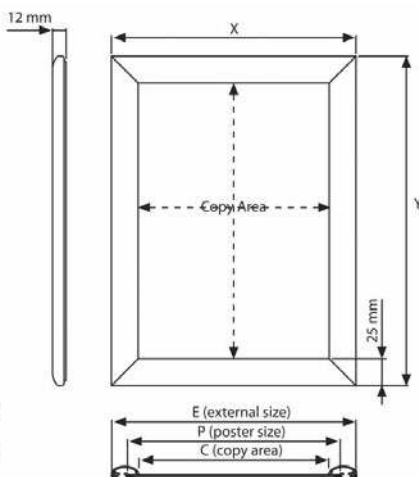
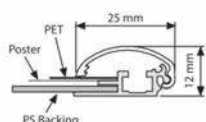

### FOGLI ANTIRIFLESSO DI RICAMBIO

Codice art.	Descrizione	Formato cm.	Spess. my	LP
KKPVM303550	Antiriflesso 300	35x50	300	1,50
KKPVM305070	Antiriflesso 300	50x70	300	3
KKPVM307010	Antiriflesso 300	70x100	300	6
KKPVM501014	Antiriflesso 500	100x140	500	19

### SCHEDA TECNICA

Codice art.	Colore	Dim. cm.	Poster cm.	Angolo	Peso Kg.	L.P.
MTSECKKS245	Silver	53x73	50x70	45°	2.45	49
MTSECKKS145	Silver	73x103	70x100	45°	4.33	76
MTSECKKS045	Silver	103x143	100x140	45°	5.55	130
MTUTE	Utensile per apertura cornici					3

**KLIK KLAK®**



# ECO KLIK KLAK

## WATERPROOF

Cornice klik klak con profilo in alluminio da mm. 25, resistente alle intemperie e con fori di drenaggio per l'acqua; il profilo è fissato tramite una vite sbloccabile con l'apposita chiave.

Ora disponibili i fogli di ricambio antiriflesso.

*Klik Klak frame with aluminum mm. 25, weather resistant and with drainage holes for water; the profile is secured by a screw unlockable with the special key.*

*Now availables replacement anti-reflection sheets.*

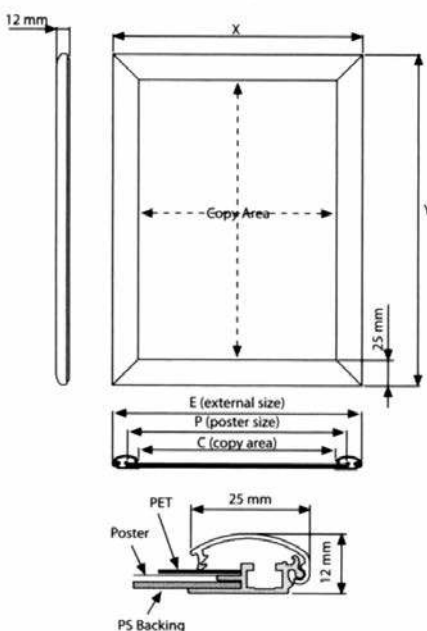

### FOGLI ANTIRIFLESSO DI RICAMBIO

Codice art.	Descrizione	Formato cm.	Spess. my	LP
KKPVM303550	Antiriflesso 300	35x50	300	1,50
KKPVM305070	Antiriflesso 300	50x70	300	3
KKPVM307010	Antiriflesso 300	70x100	300	6
KKPVM501014	Antiriflesso 500	100x140	500	19

### SCHEDA TECNICA

Codice art.	Colore	Dim. cm.	Grafica cm.	Peso Kg.	L.P.
MTWPKKS245	Silver	55x75	50x70	2.1	57
MTWPKKS145	Silver	75x105	70x100	3.9	90
MTWPKKS045	Silver	105x145	100x140	6.05	156

Cornice klik klak in alluminio anodizzato, colore silver, con fondale in plastica antigraffio e protezione antiriflesso sul fronte. Ora disponibili i fogli di ricambio antiriflesso.

*Klik Klak frame in anodized aluminum, silver color, with bottom in plastic anti-scratch and anti-glare protection on the front. Now availables replacement anti-reflection sheets.*

## SCHEMA TECNICA

Codice art.	Formato cm.	L.P.
DSKKA4	21x30	44
DSKKA3	42x30	53
DSKK3550	35x50	66
DSKKB2	50x70	78
DSKKB1	70x100	108
DSKKB0	100x140	161

## FOGLI ANTIRIFLESSO DI RICAMBIO

Codice art.	Descrizione	Formato cm.	Spess. my	LP
KKPVM303550	Antiriflesso 300	35x50	300	1,50
KKPVM305070	Antiriflesso 300	50x70	300	3
KKPVM307010	Antiriflesso 300	70x100	300	6
KKPVM501014	Antiriflesso 500	100x140	500	19



# CORNICE SLIDE

Cornice bifacciale in alluminio anodizzato Silver, con film protettivo antiriflesso; incluso il biadesivo posto sulla base. Utilizzabile anche per segnaletica bifacciale da interni.

Ora disponibili i fogli di ricambio antiriflesso.

*Double-Sided silver anodized aluminum frame, with anti-glare protective film; including double-sided tape on the base. It can also be used for double-sided signs interior. Now availables replacement anti-reflection sheets.*



## FOGLI ANTIRIFLESSO DI RICAMBIO

Codice art.	Descrizione	Formato cm.	Spess. my	LP
KKPVM303550	Antiriflesso 300	35x50	300	1,50
KKPVM305070	Antiriflesso 300	50x70	300	3
KKPVM307010	Antiriflesso 300	70x100	300	6
KKPVM501014	Antiriflesso 500	100x140	500	19

## SCHEMA TECNICA

Codice art.	Dim. cm.	Poster cm.	Peso Kg.	Imballo cm.	L.P.
MTCOSLA4	31x23	29.7x21	0.9	26x36x7	30
MTCOSLA3	43x31	42x29.7	1.2	34x47x7	40

# WINDOWS FRAME

Cornice in materiale plastico per messaggi bifacciali da apporre su vetro; compreso nel kit il biadesivo di fissaggio e la finta cornice da fissare posteriormente. Disponibile nei colori B (nero) e G (grigio).

Plastic frame for double sided messages to be affixed on the glass; included in the kit the double-sided tape for fixing and the false frame to be fixed at the back. Available in B (black) and G (grey) colours.

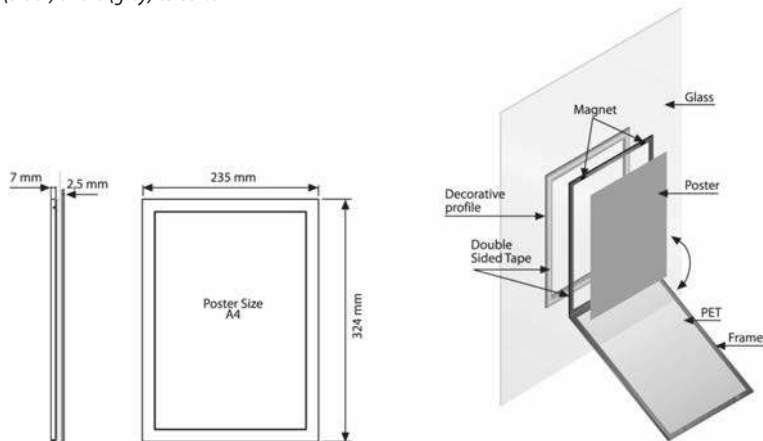

CORNICI

84

## SCHEDA TECNICA

Codice art.	Colore	Dim. cm.	Poster cm.	Peso Kg.	Imballo cm.	L.P.
MTWIFRA4N	Nero	23,5x32,4	21x29,7	0,35	25x35x2	13
MTWIFRA4G	Grigio	23,5x32,4	21x29,7	0,35	25x35x2	13

# KLICK KLAK GLASS

Cornice Klik Klak in alluminio Silver di spessore mm. 25, per l'esposizione e la sostituzione rapida di manifesti su vetri, visibili sia da lato interno che da quello esterno grazie al profilo che simula la cornice posteriore. Pellicola antiriflesso e biadesivo inclusi nella confezione. Ora disponibili i fogli di ricambio antiriflesso.

Klik Klak Aluminium Silver frame mm thick. 25, for the display and the quick replacement of posters on glasses, visible both from the inside and from outside thanks to the profile that simulates the rear frame. Double-sided anti-reflection film included. Now availables replacement anti-reflection sheets.

**KLICK KLAK**<sup>®</sup>

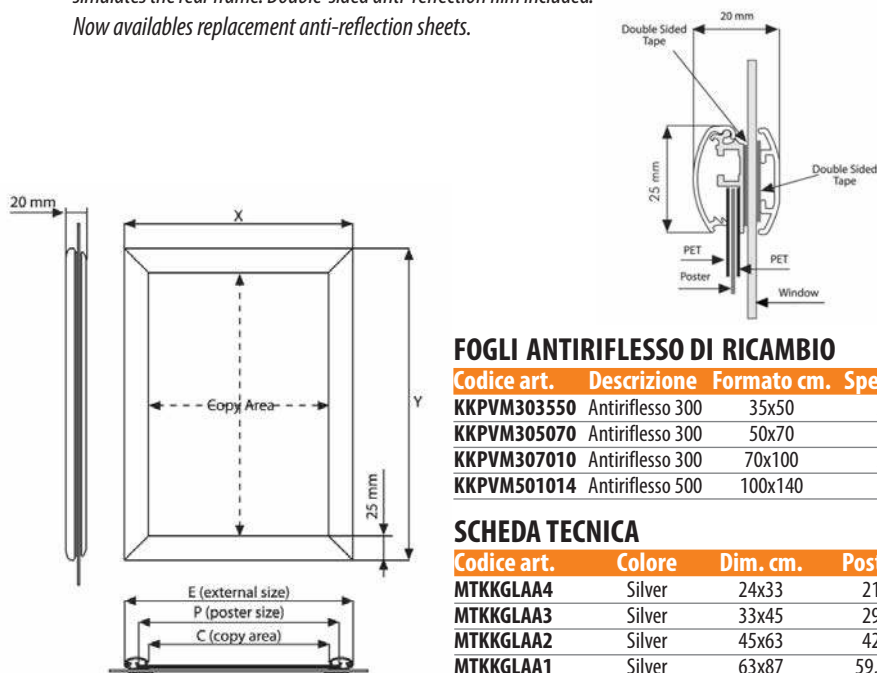

## FOGLI ANTIRIFLESSO DI RICAMBIO

Codice art.	Descrizione	Formato cm.	Spess. my	L.P.
KKPVM303550	Antiriflesso 300	35x50	300	1,50
KKPVM305070	Antiriflesso 300	50x70	300	3
KKPVM307010	Antiriflesso 300	70x100	300	6
KKPVM501014	Antiriflesso 500	100x140	500	19

## SCHEDA TECNICA

Codice art.	Colore	Dim. cm.	Poster cm.	Peso Kg.	Imballo cm.	L.P.
MTKKGLAA4	Silver	24x33	21x29,7	0,6	26x35x2	28
MTKKGLAA3	Silver	33x45	29,7x42	0,9	35x46x2	34
MTKKGLAA2	Silver	45x63	42x59,4	1,1	46x66x2	45
MTKKGLAA1	Silver	63x87	59,4x84,1	2,1	65x90x2	62
MTKKGLAB2	Silver	53x73	50x70	1,4	55x75x2	50
MTKKGLAB1	Silver	73x103	70x100	2,7	75x105x2	73

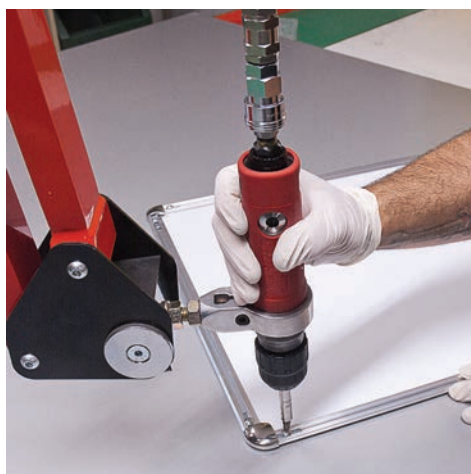

**REALIZZIAMO A RICHIESTA CORNICI KLIK KLAK SU MISURA:** È SUFFICIENTE SAPERE LA QUANTITÀ DESIDERATA ED IL FORMATO, SIA DI INGOMBRO ESTERNO CHE DEL POSTER INTERNO E, IN MENO DI 24 ORE, IL VOSTRO PREVENTIVO PERSONALIZZATO SARÀ PRONTO. È POSSIBILE SCEGLIERE TRA 2 TIPOLOGIE E DI PROFILO DIVERSE: **IL PRIMO INDICATO FOTO A**, È DI SPESSORE mm 25 (È LO STESSO DELLA CORNICE ECO KLIK KLAK), MENTRE **IL SECONDO**, **INDICATO IN FOTO B**, È DI SPESSORE mm 32; È POSSIBILE REALIZZARLE CON ANGOLO TONDO.

## MODELLO A

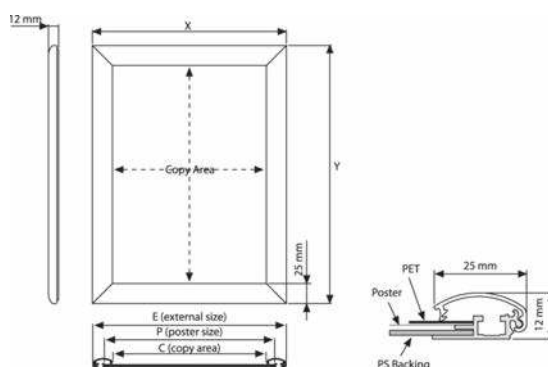

## MODELLO B

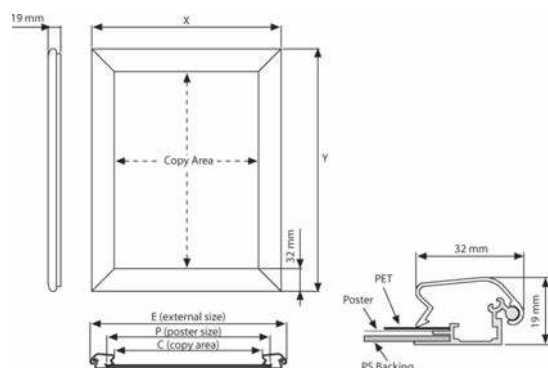
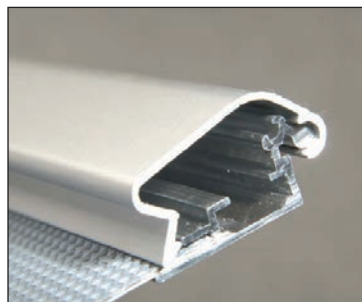

# CORNICI ALU STYLE MOD. A

**new  
PRODUCT**

Cornici in alluminio disponibili in finitura argento satinato, argento cromato o nero opaco, con angoli a 45°. Possono ospitare pannelli fino ad un massimo spessore di mm. 10; nel kit di montaggio sono incluse le squadrette angolari con fissaggio a vite, i bumper autoadesivi, le molle di compensazione ed il profilo murale FRAEX05 per il fissaggio al muro.

Aluminum frames available in satin silver, chrome silver and matt black finishing, with 45° corners. It is suitable for panels of maximum thickness mm. 10; in the assembly kit are included brackets with screw fixing, self-adhesive bumpers, coat hangers and compensation springs. Wall fixing through FRAEX05 profile (included).

## SCHEDA TECNICA

Codice art.	Finitura	Dim. Est. cm.	Grafica cm.	L.P.
EUALUSTY2130ASA	Argento satinato	22x31	21x30	20
EUALUSTY3040ASA	Argento satinato	31x41	30x40	24
EUALUSTY3550ASA	Argento satinato	36x51	35x50	27
EUALUSTY5050ASA	Argento satinato	51x51	50x50	30
EUALUSTY5070ASA	Argento satinato	51x71	50x70	38
EUALUSTY710ASA	Argento satinato	71x101	70x100	44
EUALUSTY1010ASA	Argento satinato	101x101	100x100	50
EUALUSTY1014ASA	Argento satinato	101x141	100x140	60
EUALUSTY2130ACA	Argento cromato	22x31	21x30	30
EUALUSTY3040ACA	Argento cromato	31x41	30x40	36
EUALUSTY3550ACA	Argento cromato	36x51	35x50	40
EUALUSTY5050ACA	Argento cromato	51x51	50x50	45
EUALUSTY5070ACA	Argento cromato	51x71	50x70	52
EUALUSTY710ACA	Argento cromato	71x101	70x100	66
EUALUSTY1010ACA	Argento cromato	101x101	100x100	75
EUALUSTY1014ACA	Argento cromato	101x141	100x140	90
EUALUSTY2130NEA	Nero opaco	22x31	21x30	20
EUALUSTY3040NEA	Nero opaco	31x41	30x40	24
EUALUSTY3550NEA	Nero opaco	36x51	35x50	27
EUALUSTY5050NEA	Nero opaco	51x51	50x50	30
EUALUSTY5070NEA	Nero opaco	51x71	50x70	38
EUALUSTY710NEA	Nero opaco	71x101	70x100	44
EUALUSTY1010NEA	Nero opaco	101x101	100x100	50
EUALUSTY1014NEA	Nero opaco	101x141	100x140	60



PROFILO MURALE FRAEX 05  
Vedi pag. 92

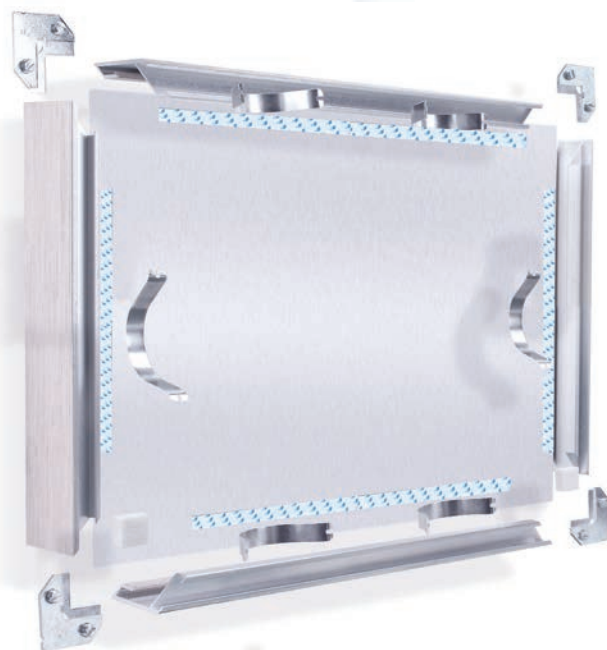

N.B. : PER FACILITARE LE OPERAZIONI DI MONTAGGIO LE CORNICI VENGONO FORNITE SMONTATE IN KIT DI MONTAGGIO, PANNELLI ESCLUSI.

N.B.: TO FACILITATE THE SETTING UP THE FRAMES ARE SUPPLIED DISASSEMBLED IN KIT ASSEMBLY, PANELS EXCLUDED.

## NERO OPACO

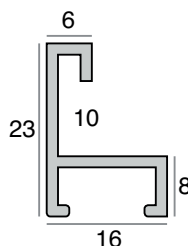

## ARGENTOSATINATO



## ARGENTOCROMATO



SQUADRETTE DI FISSAGGIO



BUMPER PROTETTIVI



MOLLE AD ARCO

**ALTRE MISURE SU RICHIESTA**



# CORNICI ALU STYLE MOD.B

Cornici in alluminio disponibili in finitura argento satinato o nero opaco, creano un particolare effetto d'ombra lungo i bordi del pannello (fissato tramite biadesivo) facendolo sembrare sospeso. Nel kit di montaggio sono incluse le squadrette angolari con fissaggio a vite ed i bumper autoadesivi, oltre al profilo murale FRAEX05 che ne permette il fissaggio a muro.

Aluminum frames available both in satin silver and matt black finishing, they create a particular shadow effect in the edges making the panel seem like suspended. In the assembly kit are included brackets with screw fixing, self-adhesive bumpers and FRAEX05 profile for wall fixing.

## SCHEMA TECNICA

Codice art.	Finitura	Grafica cm.	L.P.
EUALUSTY2130ASB	Argento satinato	21x30	32
EUALUSTY3040ASB	Argento satinato	30x40	42
EUALUSTY3550ASB	Argento satinato	35x50	49
EUALUSTY5050ASB	Argento satinato	50x50	56
EUALUSTY5070ASB	Argento satinato	50x70	66
EUALUSTY710ASB	Argento satinato	70x100	90
EUALUSTY1010ASB	Argento satinato	100x100	104
EUALUSTY1014ASB	Argento satinato	100x140	128
EUALUSTY2130NEB	Nero opaco	21x30	32
EUALUSTY3040NEB	Nero opaco	30x40	42
EUALUSTY3550NEB	Nero opaco	35x50	49
EUALUSTY5050NEB	Nero opaco	50x50	56
EUALUSTY5070NEB	Nero opaco	50x70	66
EUALUSTY710NEB	Nero opaco	70x100	90
EUALUSTY1010NEB	Nero opaco	100x100	104
EUALUSTY1014NEB	Nero opaco	100x140	128



## NERO OPACO



## ARGENTO SATINATO

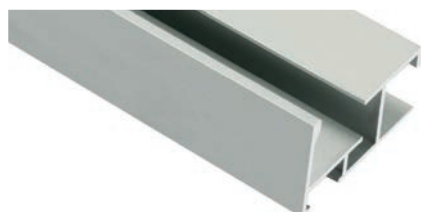

PROFILO MURALE FRAEX 05  
Vedi pag. 92

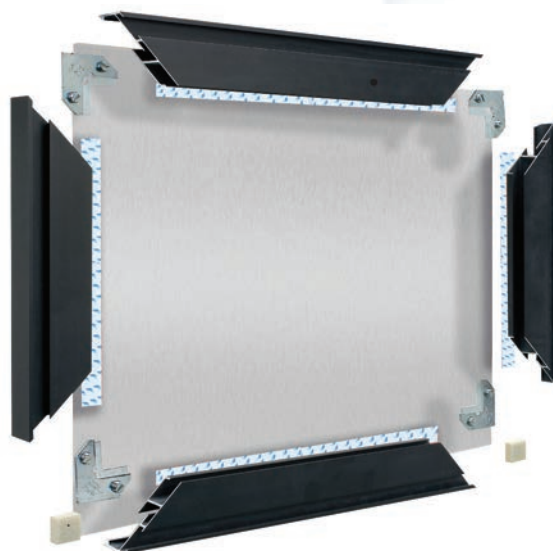

N.B. : PER FACILITARE LE OPERAZIONI DI MONTAGGIO LE CORNICI VENGONO FORNITE SMONTATE IN KIT DI MONTAGGIO, PANNELLI ESCLUSI.  
N.B. : TO FACILITATE THE SETTING UP THE FRAMES ARE SUPPLIED DISASSEMBLED IN KIT ASSEMBLY, PANELS EXCLUDED.

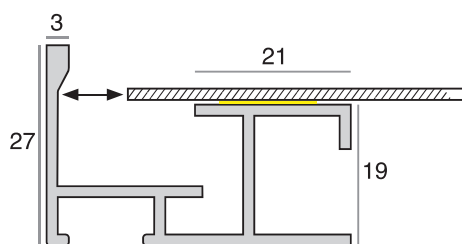

SQUADRETTE DI FISSAGGIO



BUMPER PROTETTIVI

ALTRE MISURE SU RICHIESTA

# CORNICI A SCOMPARSA

Cornici nascoste in alluminio disponibili in finitura argento satinato o alluminio, a cui è possibile fissare pannelli tramite biadesivo. La struttura portante si può fissare in due modi: tramite squadrette a 45° con viti o angolari in plastica tondi ad incastro, a scelta inclusi nel kit insieme ai bumper autoadesivi ed al profilo murale FRAEX05 tramite cui avviene il fissaggio a muro.

Aluminum frames available both in satin silver and mill finishing, where it's possible fixing panels through biadhesive. The structure can be fixed in two ways: with 45° brackets and screw fixing or round plastic corners interlocking, included choice in the assembly kit together with self-adhesive bumpers and FRAEX05 wall fixing profile.

## SCHEDA TECNICA

Codice art.	Finitura	Spessore profilo mm	Dim. cm	L.P.
EUCOSC02130AS8	Argento satinato	8	21x30	20
EUCOSC03040AS8	Argento satinato	8	30x40	24
EUCOSC03550AS8	Argento satinato	8	35x50	27
EUCOSC05050AS8	Argento satinato	8	50x50	30
EUCOSC05070AS8	Argento satinato	8	50x70	38
EUCOSC0710AS8	Argento satinato	8	70x100	44
EUCOSC01010AS8	Argento satinato	8	100x100	50
EUCOSC01014AS8	Argento satinato	8	100x140	60
EUCOSC02130AS15	Argento satinato	15	21x30	20
EUCOSC03040AS15	Argento satinato	15	30x40	24
EUCOSC03550AS15	Argento satinato	15	35x50	27
EUCOSC05050AS15	Argento satinato	15	50x50	30
EUCOSC05070AS15	Argento satinato	15	50x70	38
EUCOSC0710AS15	Argento satinato	15	70x100	44
EUCOSC01010AS15	Argento satinato	15	100x100	50
EUCOSC01014AS15	Argento satinato	15	100x140	60
EUCOSC02130AL15	Alluminio	15	21x30	11
EUCOSC03040AL15	Alluminio	15	30x40	15
EUCOSC03550AL15	Alluminio	15	35x50	16
EUCOSC05050AL15	Alluminio	15	50x50	18
EUCOSC05070AL15	Alluminio	15	50x70	21
EUCOSC0710AL15	Alluminio	15	70x100	28
EUCOSC01010AL15	Alluminio	15	100x100	32
EUCOSC01014AL15	Alluminio	15	100x140	39



PROFILO MURALE FRAEX 05  
Vedi pag. 92



BUMPER PROTETTIVI



SQUADRETTE DI FISSAGGIO  
CON VITI



ANGOLARI IN PLASTICA  
(A SCELTA SOLO PER SUB15)

## ARGENTO SATINATO

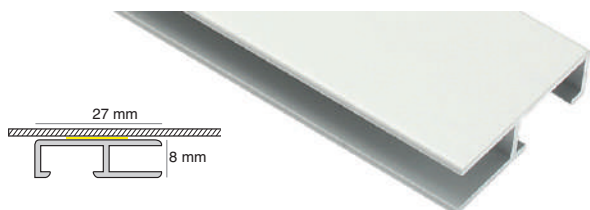

## ARGENTO SATINATO

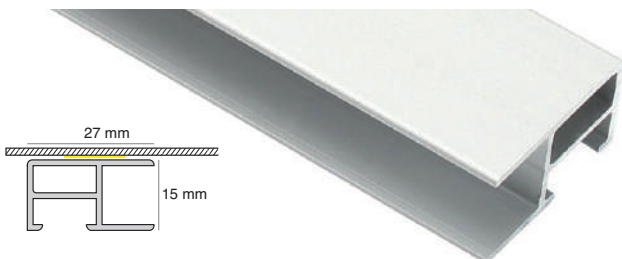

## ALLUMINIO

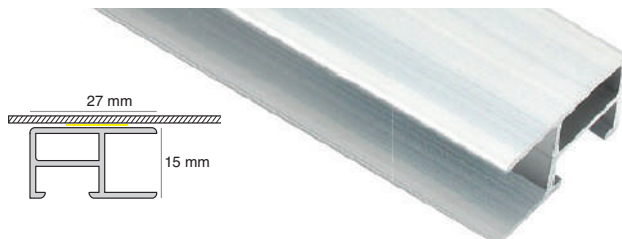

N.B. : PER FACILITARE LE OPERAZIONI DI MONTAGGIO LE CORNICI VENGONO FORNITE SMONTATE IN KIT DI MONTAGGIO, PANNELLI ESCLUSI.

N.B. : TO FACILITATE THE SETTING UP THE FRAMES ARE SUPPLIED DISASSEMBLED IN KIT ASSEMBLY, PANELS EXCLUDED.

ALTRE MISURE SU RICHIESTA

# CORNICI VARIE



*Modello a scomparsa*



*Alustyle mod. B*



*Fissaggio con aggancio senza viti grazie al profilo murale Fraex 05*



*Modello a scomparsa*

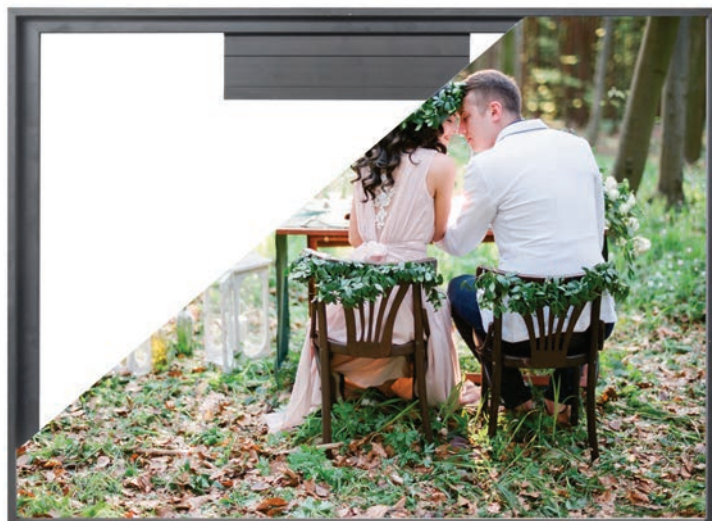

*Alustyle mod. A*

# CORNICI ALUFRAME

Cornice in alluminio con angoli a 45° tagliata a misura, per pannelli rigidi dai mm.2 ai mm. 10 di spessore; nel kit di montaggio sono comprese le squadrette con fissaggio a vite, gli appendini e le molle di compensazione. Disponibile anche con pannello in lavagna nera o bianca ri-scrivibile con pennarelli a gesso liquido base acqua in vari colori, resistenti alla pioggia; per la pulizia è sufficiente utilizzare un panno umido.

**N.B. : PER FACILITARE LE OPERAZIONI DI MONTAGGIO LE CORNICI VENGONO FORNITE SMONTATE IN KIT DI MONTAGGIO, PANNELLI ESCLUSI.**

*Aluminum frame with 45° corners cut to size, for rigid panels from 2 mm to mm. 10 thick; in the assembly kit are included the brackets with screw, coat hangers and compensation springs. Available also with blackboard front panel black or white re-writable with chalk markers in different colours, water-resistant; to wipe off can be used a damp cloth.*

**N.B.: TO FACILITATE THE SETTING UP THE FRAMES ARE SUPPLIED DISASSEMBLED IN KIT ASSEMBLY, PANELS EXCLUDED.**

## SCHEDA TECNICA

Codice art.	Colore	Dim. cm.	Poster cm.	L.P.
EUALUFRAR2130	Silver	22,4x31,4	21x30	20
EUALUFRAR3040	Silver	31,4x41,4	30x40	22
EUALUFRAR3550	Silver	36,4x51,4	35x50	23
EUALUFRAR5050	Silver	51,4x51,4	50x50	24
EUALUFRAR5070	Silver	51,4x71,4	50x70	26
EUALUFRAR710	Silver	71,4x101,4	70x100	29
EUALUFRAR1010	Silver	101,4x101,4	100x100	30
EUALUFRAR1014	Silver	101,4x141,4	100x140	36
EUALUFRNE2130	Nero	22,4x31,4	21x30	20
EUALUFRNE3040	Nero	31,4x41,4	30x40	22
EUALUFRNE3550	Nero	36,4x51,4	35x50	23
EUALUFRNE5050	Nero	51,4x51,4	50x50	24
EUALUFRNE5070	Nero	51,4x71,4	50x70	26
EUALUFRNE710	Nero	71,4x101,4	70x100	29
EUALUFRNE1010	Nero	101,4x101,4	100x100	30
EUALUFRNE1014	Nero	101,4x141,4	100x140	36

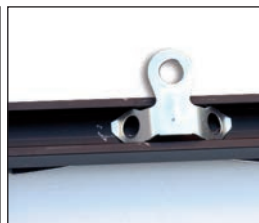
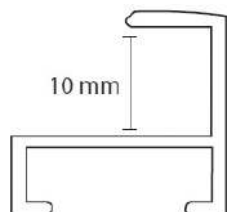
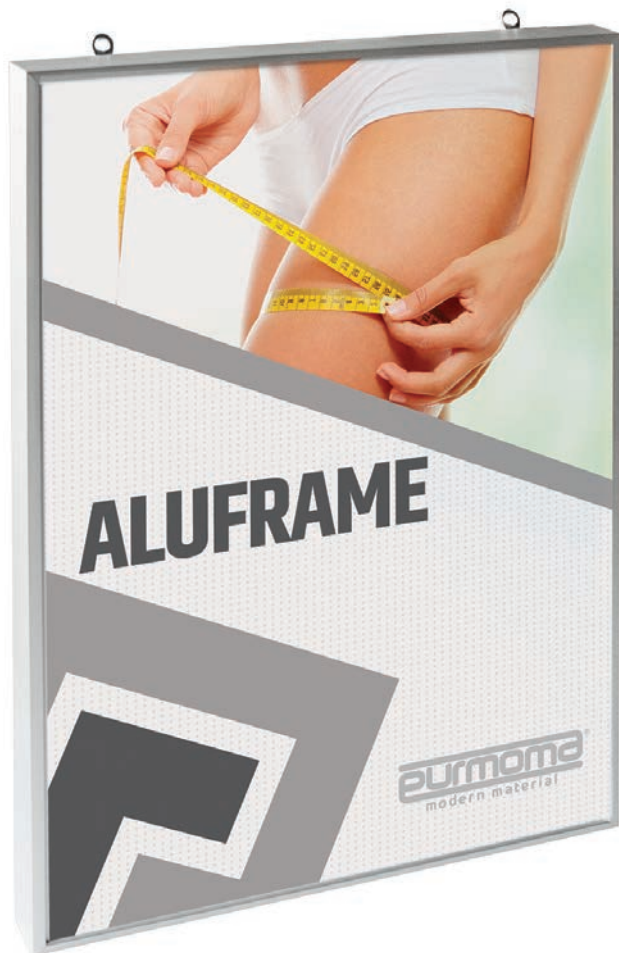

LAVAGNA BIANCA

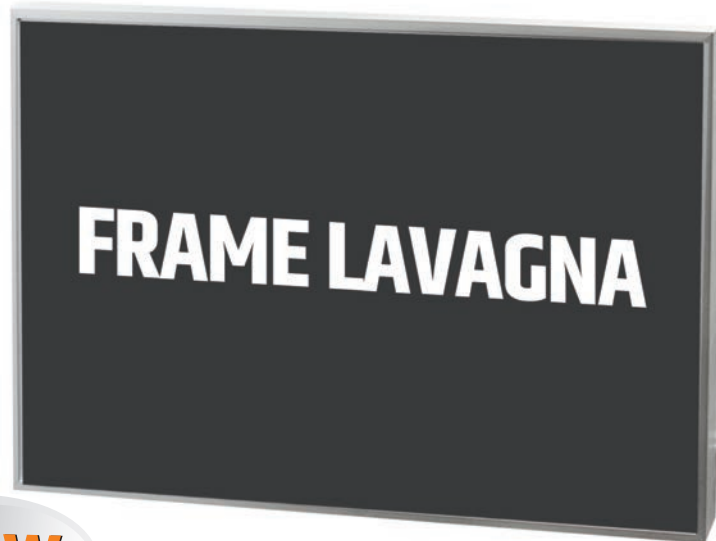

LAVAGNA NERA

## SCHEDA TECNICA

Codice art.	Descrizione	L.P.
EUFRAMELAVA4	Frame Lavagna cm. 21x30	24
EUFRAMELAVA3	Frame Lavagna cm. 30x40	28
EUFRAMELAV3550	Frame Lavagna cm. 35x50	32
EUFRAMELAV5070	Frame Lavagna cm. 50x70	42
EUFRAMELAV710	Frame Lavagna cm. 70x100	58
EUFRAMELAV1014	Frame Lavagna cm. 100x140	88
ALCPEN	Pennarello a gesso liquido disponibile Bianco, Giallo, Verde e Fuxia	22



ALTRE MISURE SU RICHIESTA

# POSTER SNAP

Profili tendi-poster in alluminio anodizzato Silver, spessore mm. 26, con chiusura a pressione ed agganci per il fissaggio a muro. Nel set sono inclusi il profilo superiore ed inferiore.

*Silver anodized aluminum posters snap, thickness mm. 26, with closure pressure and hooks for wall fixing. In the set are included profile top and bottom.*

## SCHEDA TECNICA

Codice art.	Descrizione	Poster cm.	L.P.
MTPOSNA50	Coppia barre cm. 50	50	14
MTPOSNA60	Coppia barre cm. 60	60	15
MTPOSNA70	Coppia barre cm. 70	70	16
MTPOSNA85	Coppia barre cm. 85	85	17
MTPOSNA100	Coppia barre cm. 100	100	20



# POSTER CLAMP

Coppia di barre in alluminio anodizzato Silver, spessore mm. 25, adatte per l'affissione di poster da soffitto grazie ai ganci superiori. Il poster è fissato tramite chiusura a pinza.

*Pair of anodized aluminum bars Silver, thickness mm. 25, suitable for the display of posters from the ceiling due to the upper hooks. The poster is fixed by pincers latch.*

## SCHEDA TECNICA

Codice art.	Descrizione	Poster cm.	L.P.
MTPOCLA50	Coppia barre cm. 50	50	16
MTPOCLA60	Coppia barre cm. 60	60	18
MTPOCLA70	Coppia barre cm. 70	70	20
MTPOCLA85	Coppia barre cm. 85	85	24
MTPOCLA100	Coppia barre cm. 100	100	28

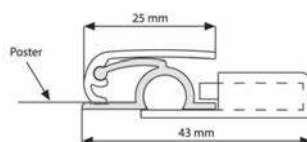

# STRECH FRAME

Pratica cornice in alluminio anodizzato Silver e angolari in plastica nera, con molle per tendere la grafica centrale tramite graffette, che consentono anche un veloce cambio immagine. Dotata di ganci, può essere sia appesa al soffitto che fissata al muro, ed è disponibile in diversi formati a scelta.

*Practical anodized aluminum Silver frame and black plastic corners with springs to stretch the graphic panel via staples, which also allow a quick change picture. Equipped with hooks, it can be either suspended from the ceiling and mounted on the wall, and is available in several formats to choose from.*

## SCHEDA TECNICA

Codice art.	Misure telaio cm.	Poster cm.	L.P.
MTSTFRA4	31x39,7	21x29,7	11
MTSTFRA3	39,7x52	29,7x42	12
MTSTFRA2	52x69,4	52x69,4	14
MTSTFRA1	69,4x94,1	69,4x94,1	16
MTSTFRB2	60x80	50x70	15
MTSTFRB1	80x110	70x100	17



# EXPO FRAME

## EXPOFRAME PROFILO MURALE FRAEX05 EXPOFRAME PROFILO INVISIBILE FRAEX10

Barre in alluminio anodizzato nero, disponibili sia con profilo murale FRAEX05 sia con profilo invisibile FRAEX10. Si adattano alle cornici FRAEX20, FRAEX14L, FRAEX14P, FRAEX14F. Massima lunghezza disponibile mt. 3.

*Black anodized aluminum bars, either available with wall profile FRAEX05 and invisible profile FRAEX10. For frames FRAEX20, FRAEX14L, FRAEX14P, FRAEX14F. maximum available length mt. 3.*

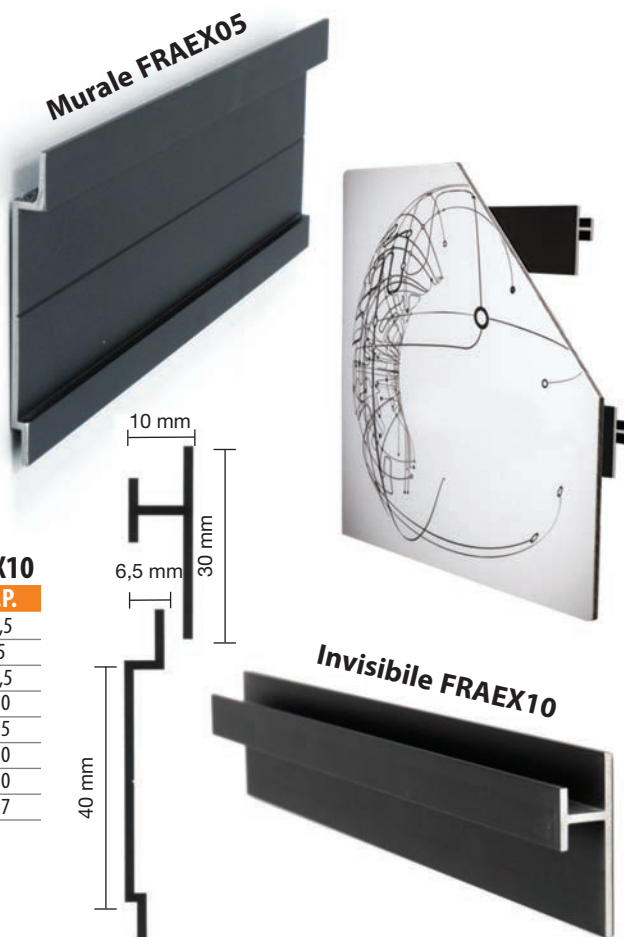

### EXPOFRAME MURALE FRAEX05

Codice art.	Lunghezza cm.	L.P.
FRAEX0510	10	1
FRAEX0515	15	1,5
FRAEX0520	20	2
FRAEX0525	25	2,5
FRAEX0550	50	5
FRAEX0575	75	7,5
FRAEX05100	100	10
FRAEX05150	150	15
FRAEX05200	200	20
FRAEX05300	300	30

### EXPOFRAME INVISIBILE FRAEX10

Codice art.	Lunghezza cm.	L.P.
FRAEX1025	25	2,5
FRAEX1050	50	5
FRAEX1075	75	7,5
FRAEX10100	100	10
FRAEX10150	150	15
FRAEX10200	200	20
FRAEX10300	300	30
1812TM25	2,5x25 mt	17

**ALTRE MISURE SU RICHIESTA**

# LAVAGNA PERSPEX

Targa in Perspex nero lucido, spessore 10 mm, disponibile in vari formati standard, scrivibile con pennarelli a gesso liquido facilmente cancellabili.

Si consiglia di utilizzare i distanziali mm. 19x25 (vedi pag.173-174-175).

*Black gloss Perspex sheet, thickness mm. 10, available in various standard sizes, writable with liquid chalk pens easily removable. We recommend using spacers size mm. 19x25 (pag. 173-174-175).*

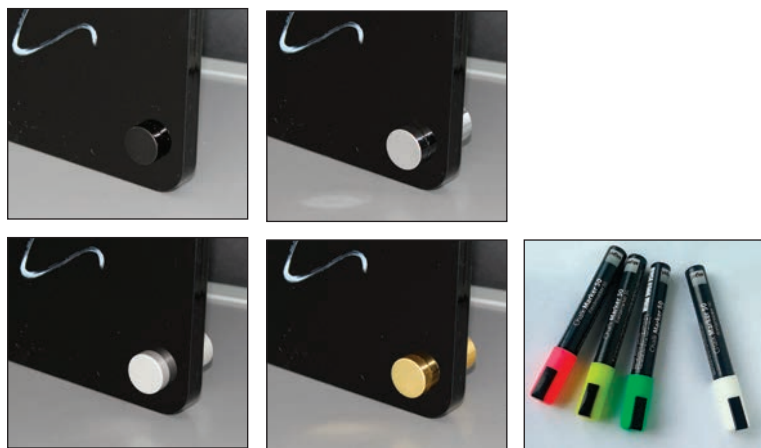

### SCHEMA TECNICA

Codice art.	Descrizione	L.P.
EULAPE3375	Lavagna Perspex nero dim. cm.33x75 con 6 fori	78
EULAPE50100	Lavagna Perspex nero dim. cm.50x100 con 6 fori	160
EULAPE66150	Lavagna Perspex nero dim. cm.66x150 con 6 fori	230
EULAPE75200	Lavagna Perspex nero dim. cm.75x200 con 6 fori	350
ALCPEN	Pennarello a gesso liquido disponibile Bianco, Giallo, Verde e Fuxia	22



# MAGNETIC LIGHT BOX

Soluzione espositiva per valorizzare messaggi rivolti al pubblico, composta da tasca trasparente in Perspex con integrati serie di LED; grazie allo speciale pannello acrilico, la luminosità è intensa e omogenea e risalta la grafica esposta. La tasca è fissata mediante cavi di acciaio e fissaggi a soffitto; gli stessi hanno anche la funzione di cablaggio elettrico in bassa tensione a 12 Volt. Le tasche sono disponibili nei formati A4 e A3 nella versione monofacciale sia orizzontale che verticale.

*Expositive solution to valorize messages to the public, consisting of a transparent Perspex pocket with LED in it; thanks to the special acrylic panel, the brightness is intense and homogeneous and gives valor to the exposed graphic. The pocket is fixed through steel wires and ceiling fixings, which also have the function of electric wiring in 12 Volt low tension. Pockets are available in A4 and A3 monofacial format, both horizontal and vertical.*



LED PANEL VERTICALE



LED PANEL ORIZZONTALE

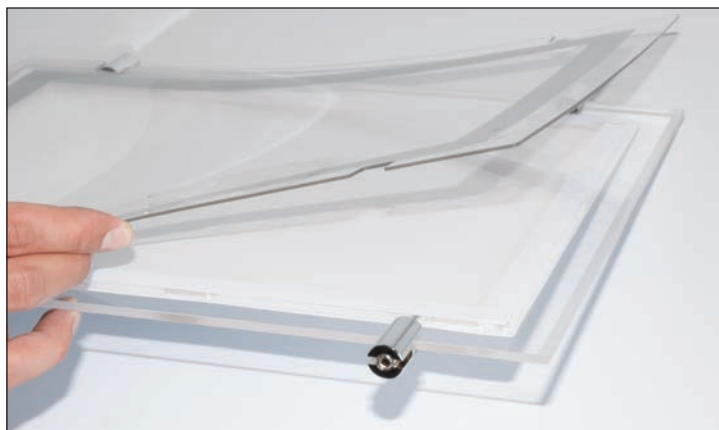

## SCHEDA TECNICA

Codice art.	Descrizione	Dim. cornice mm.	Dim. grafica mm.	Spess. cornice mm.	Volt	Potenza Watt	L.P.
UFLBBA4P	Led Pannel f.to A4 verticale	363x276	297x210	8	24	4,8	165
UFLBBA4L	Led Pannel f.to A4 orizzontale	363x276	297x210	8	24	4,8	165
UFLBBA3P	Led Pannel f.to A3 verticale	486x363	420x297	8	24	4,8	220
UFLBBA3L	Led Pannel f.to A3 orizzontale	486x363	420x297	8	24	4,8	220
ETGS1512	Alimentatore Wall Mount 24V 15W 1,25A				24	15	51
ETGS4012	Alimentatore Desktop 24V 40W 3,34A				24	40	59
ETGS9012	Alimentatore Desktop 24V 80W 6,67A				24	80	109
UF2M	Cavo alimentazione con spinotto						5
UFBf0155	Kit sosp. Attacchi cielo/terra + cavo acciaio + isolanti						24
UFCF08	Connettore alimentazione						3
ETSPINA	Spina per alimentatore desktop						10

# MAGNETIC LIGHT BOX





# MAGNETIC LIGHT BOX

## ISTRUZIONI DI MONTAGGIO



LED PANEL A4 VERTICALE



LED PANEL A4 ORIZZONTALE



LED PANEL A3 VERTICALE



LED PANEL A3 ORIZZONTALE



KIT SOSPENSIONE ATTACCHI CIELO/TERRA+CAVI ACCIAIO+ISOLANTI



ALIMENTATORE WALLMOUNT  
24V - 15W - 1,25A



CAVO ALIMENTAZIONE  
CON SPINOTTO



CONNETTORE  
ALIMENTAZIONE



ALIMENTATORE DESKTOP 24V - 40W - 3,34A



ALIMENTATORE DESKTOP 24V - 80W - 6,67A

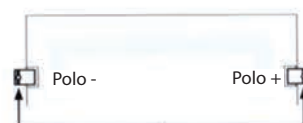
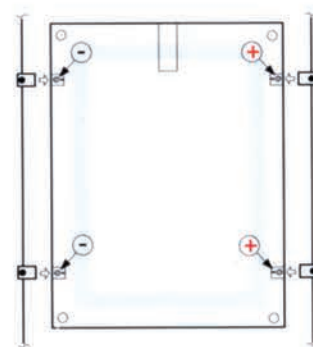
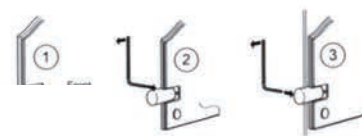

Conessioni elettriche

**Attenzione:**  
rispettare le polarità delle tasche  
come indicato in figura

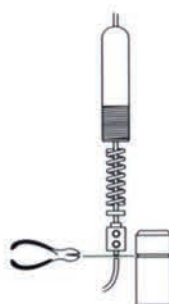
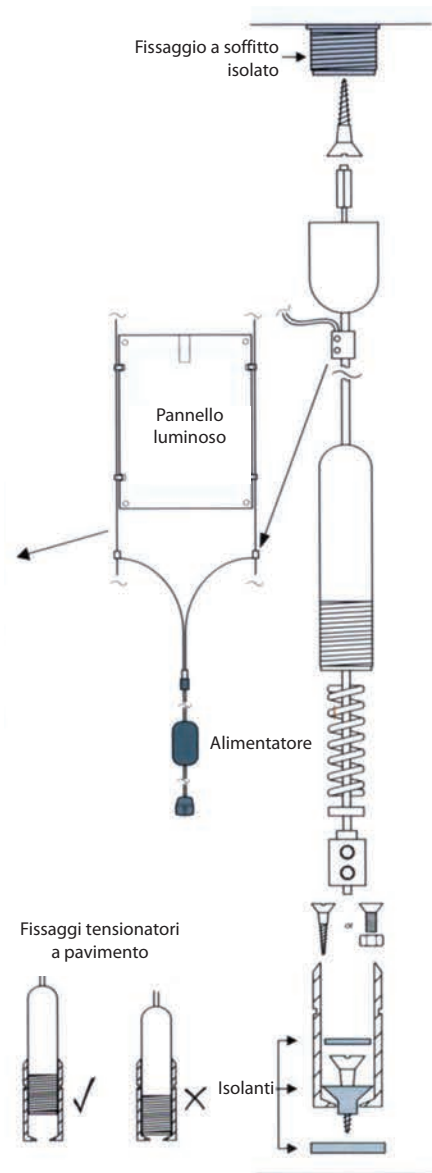

Fissaggi tensionatori  
a pavimento

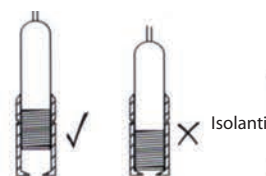

Isolanti

# BACHECA NOTES

Bacheca per l'esposizione di messaggi rivolti alle comunità; indispensabile strumento, particolarmente indicato per hall di alberghi, ambienti didattici, aziende, ecc. E' realizzata interamente in alluminio anodizzato silver; lo sportello, incernierato alla struttura, è dotato di asta, che garantisce la tenuta dell'apertura, e di serratura a chiave per un uso improprio. Può essere esposta anche in esterno, l'affissione dei messaggi può essere effettuata mediante magneti o spilli, in quanto il fondo è composto da pannelli in metallo forato, con fondo in sughero. Disponibile in diversi formati.

Showcase for messages, useful in particular to hotel halls, schools, companies, ecc. It is entirely realized in silver aluminum, and the door is hinged to the structure and provided of a pole which guarantees the right opening; it is provided of key lock. It is suitable for outdoor use too, and it is possible to post messages through magnets or pins, because the bottom is made of perforated metal panels, with cork behind. Available in several sizes.



		A4	A4	A4	A4	A4	A4	A4	A4
A4	A4	A4	A4	A4	A4	A4	A4	A4	A4
A4	A4	A4	A4	A4	A4	A4	A4	A4	A4
4 x A4	6 x A4	9 x A4	12 x A4						

## SCHEMA TECNICA

Codice art.	Descrizione	Dim. interne cm.	Poster cm.	L.P.
MTBAN04A4	Bacheca notes 4 f.ti A4	49,5x66,5	58,5x75,5	226
MTBAN06A4	Bacheca notes 6 f.ti A4	49,5x98,5	58,5x107,5	279
MTBAN09A4	Bacheca notes 9 f.ti A4	72,5x98,5	81,5x107,5	354
MTBAN012A4	Bacheca notes 12 f.ti A4	95,5x98,5	104,5x107,5	424

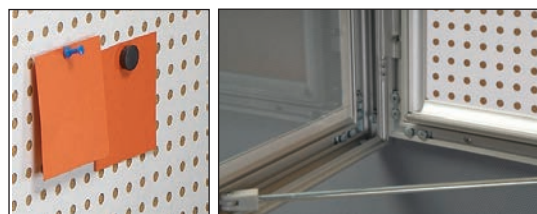

# BACHECA NOTES LED

Bacheca a LED per l'esposizione di messaggi rivolti alle comunità; indispensabile strumento, particolarmente indicato per hall di alberghi, ambienti didattici, aziende, ecc. E' realizzata interamente in alluminio anodizzato silver; lo sportello, incernierato alla struttura, è dotato di asta, che garantisce la tenuta dell'apertura, e di serratura a chiave per un uso improprio. Può essere esposta anche in esterno, l'affissione dei messaggi può essere effettuata mediante magneti o spilli, in quanto il fondo è composto da pannelli in metallo forato, con fondo in sughero. Disponibile in diversi formati.

LED showcase for messages, useful in particular to hotel halls, schools, companies, ecc. It is entirely realized in silver aluminum, and the door is hinged to the structure and provided of a pole which guarantees the right opening; it is provided of key lock. It is suitable for outdoor use too, and it is possible to post messages through magnets or pins, because the bottom is made of perforated metal panels, with cork behind. Available in several sizes.

		A4	A4	A4	A4	A4
A4	A4	A4	A4	A4	A4	A4
A4	A4	A4	A4	A4	A4	A4
4 x A4	6 x A4	9 x A4				

## SCHEMA TECNICA

Codice art.	Descrizione	Dim. interne cm.	Poster cm.	L.P.
MTBALED4A4	Bacheca notes LED 4 f.ti A4	48,3x65,3	59x76	528
MTBALED6A4	Bacheca notes LED 6 f.ti A4	48,3x97,3	59x108	590
MTBALED9A4	Bacheca notes LED 9 f.ti A4	71,3x97,3	82x108	749



# BACHECA

Bacheca (ex Poster Showboard) porta-messaggi impermeabile, in alluminio anodizzato Silver, spessore mm. 45, apribile mediante cerniere. È dotata di chiusura a chiave.

Message door - posts waterproof (ex Posters showboard) in anodized Silver aluminum, thickness mm. 45, opening by hinges. It is equipped with a key lock.



## SCHEDA TECNICA

Codice art.	Descrizione	Misure cm.	Poster cm.	L.P.
MTBACHA4	Bacheca A4	28x36,7	21x29,7	80
MTBACHA3	Bacheca A3	36,7x49	29,7x42	104
MTBACHB2	Bacheca B2	57x77	50x70	150
MTBACHB1	Bacheca B1	77x107	70x100	236

# BACHECA PLUS

Bacheca per l'esposizione di messaggi rivolti alle comunità; indispensabile strumento, particolarmente indicato per hall di alberghi, ambienti didattici, aziende, ecc. È realizzata interamente in alluminio anodizzato silver; lo sportello, dotato di testata dedicata al logo aziendale, incernierato alla struttura, è dotato di asta, che garantisce la tenuta dell'apertura, e di serratura a chiave per un uso improprio. Può essere esposta anche in esterno, l'affissione dei messaggi può essere effettuata mediante magneti, in quanto il fondo è composto da pannello in metallo.

Disponibile in diversi formati verticali e orizzontali.

Showcase for messages, useful in particular to hotel halls, schools, companies, ecc. It is entirely realized in silver aluminum, and the door is provided of header for company logo, hinged to the structure and provided of key lock and pole which guarantees the right opening. It is suitable for outdoor use too, and it is possible to post messages through magnets, because the bottom is made of perforated metal panel.

Available in several sizes both vertical and horizontal.



## SCHEDA TECNICA

Codice art.	Descrizione	Disposizione	Dim. interne cm.	Dim. esterne cm.	L.P.
MTBAPLU4A4	Bacheca Plus 4 f.ti A4	verticale	49,5x66,5	58,5x75,5	327
MTBAPLU6A4	Bacheca Plus 6 f.ti A4	verticale	49,5x98,5	58,5x107,5	416
MTBAPLU9A4	Bacheca Plus 9 f.ti A4	verticale	72,5x98,5	81,5x107,5	496
MTBAPLU12A4	Bacheca Plus 12 f.ti A4	verticale	95,5x98,5	104,5x107,5	592
MTBAPLU4A4H	Bacheca Plus 4 f.ti A4	orizzontale	65,3x48,3	76x70	340
MTBAPLU6A4H	Bacheca Plus 6 f.ti A4	orizzontale	73x48,3	108x70	434
MTBAPLU9A4H	Bacheca Plus 9 f.ti A4	orizzontale	73x71,3	108x93	522
MTBAPLU12A4H	Bacheca Plus 12 f.ti A4	orizzontale	73x94,3	108x116	612



# BANNER BOX 60



Soluzione per la realizzazione di cassonetti monofacciali per tensionamento del banner; sono realizzati con profilati in alluminio, cornice mm.60x60, con sistema di apertura facilitata klik-klak. La sostituzione della grafica è molto semplice, in quanto la tensione del banner è garantita da una serie di ganci a molla; infatti è sufficiente tagliare il banner e applicare degli occhielli di uso comune. Vengono proposti in formati standard, forniti in kit di montaggio. Il kit comprende: profili alluminio a misura con taglio a 45°, squadrette di montaggio, pannello di fondo in alluminio composito, ferramenta necessaria, escluso il banner e gli occhielli. È possibile renderli luminosi aggiungendo moduli a Led e alimentatori.

*Solution to build monofacial boxes to stretch banner, realized with aluminum profiles, frame mm. 60x60, and easy klik-klak opening. Replacing the graphic is easy because the banner is stretched thanks to several spring hooks; it is enough to cut the banner and put common eyelets. Here you find a standard proposal with mounting kit. Kit includes: 45° cut tailored aluminum profiles, mounting brackets, bottom panel in composite aluminum, ironware; banner and eyelets are not included. It is possible to make them bright by adding led modules and power supplies.*

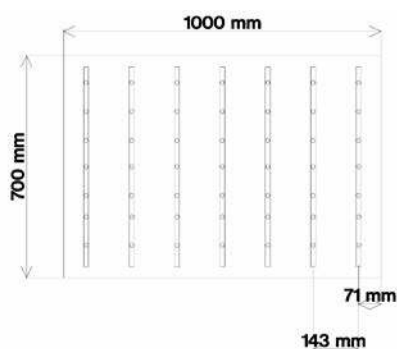

## SCHEDA TECNICA

Codice art.	Descrizione	Dimen. poster cm.	Dimen. esterne cm.	Dimen. visualiz. cm.	L.P.
EUBABL710	kit struttura cm.70x100	70x100	72x102	60x90	416
Codice art.	Descrizione				L.P.
EUIEBABL710	nr. 7 barre LED cm.63 + cablaggio + alimentatore 35w/24v				248

**ALTRE MISURE SU RICHIESTA**

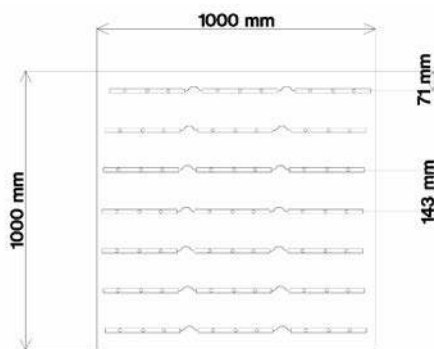

### SCHEDA TECNICA

Codice art.	Descrizione	Dimen. poster cm.	Dimen. esterne cm.	Dimen. visualiz. cm.	L.P.
EUBABL1010	kit struttura cm.100x100	100x100	102x102	90x90	450

Codice art.	Descrizione	L.P.
EUIEBABL1010	nr.21 barre LED cm.27 + cablaggio + alimentatore 100w/24v	362

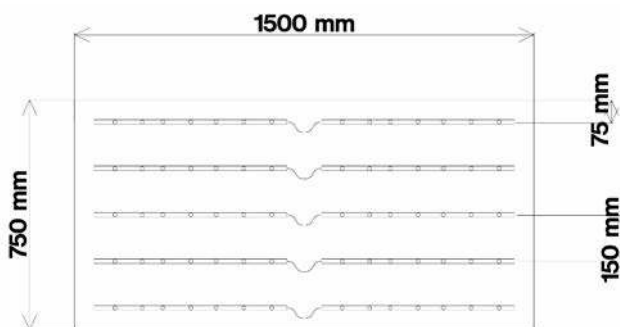

### SCHEDA TECNICA

Codice art.	Descrizione	Dimen. poster cm.	Dimen. esterne cm.	Dimen. visualiz. cm.	L.P.
EUBABBL7515	kit struttura cm.75x150	75x150	77x152	65x140	480

Codice art.	Descrizione	L.P.
EUIEBABL7515	nr. 10 barre LED cm.63 + cablaggio + alimentatore 60w/24v	323

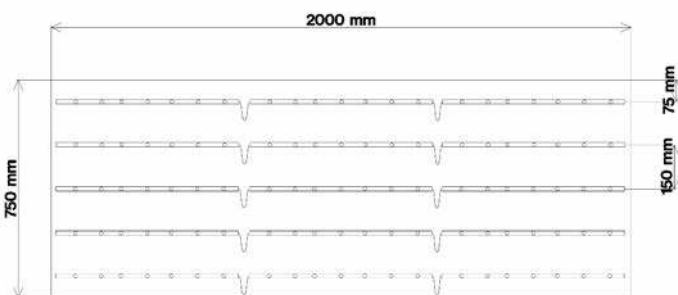

### SCHEDA TECNICA

Codice art.	Descrizione	Dimen. poster cm.	Dimen. esterne cm.	Dimen. visualiz. cm.	L.P.
EUBABL7520	kit struttura cm.75x200	75x200	77x202	65x190	650

Codice art.	Descrizione	L.P.
EUIEBABL7520	nr. 15 barre LED cm.63 + cablaggio + alimentatore 60w/24v	443

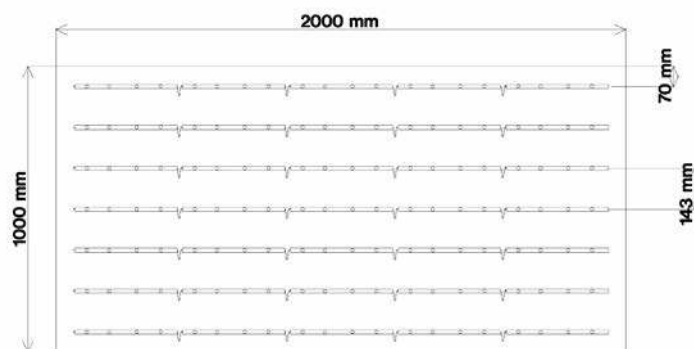

### SCHEDA TECNICA

Codice art.	Descrizione	Dimen. poster cm.	Dimen. esterne cm.	Dimen. visualiz. cm.	L.P.
EUBABL1020	kit struttura cm.100x200	100x200	102x202	90x190	700

Codice art.	Descrizione	L.P.
EUIEBABL1020	nr. 35 barre LED cm.36 + cablaggio + alimentatore 2x100w/24v	766

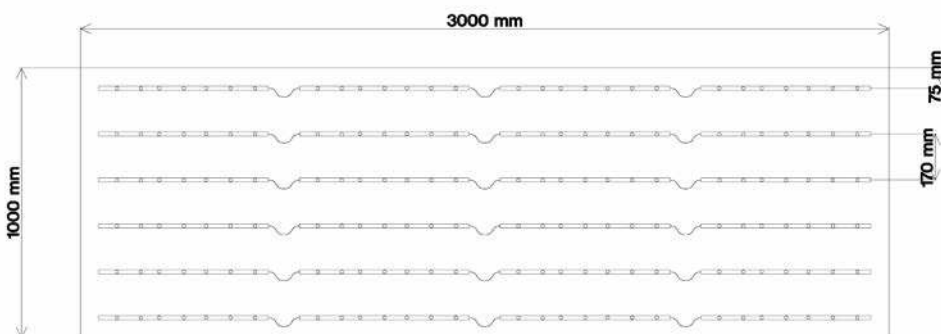

### SCHEDA TECNICA

Codice art.	Descrizione	Dimen. poster cm.	Dimen. esterne cm.	Dimen. visualiz. cm.	L.P.
EUBABL1030	kit struttura cm.100x300	100x300	102x302	90x290	900

Codice art.	Descrizione	L.P.
EUIEBABL1030	nr. 24 barre LED cm.63 + cablaggio + alimentatore 100w/24v	796

# BANNER BOX 125

CORNICI

100



Soluzione per la realizzazione di grandi cassonetti monofacciali per tensionamento del banner; sono realizzati con profilati in alluminio, cornice mm.125x60, con sistema di apertura facilitata klik-klak. La sostituzione della grafica è molto semplice, in quanto la tensione del banner è garantita da una serie di ganci a molla; infatti è sufficiente tagliare il banner e applicare degli occhielli di uso comune. Vengono proposti in formati standard, forniti in kit di montaggio.

Il kit comprende: profili alluminio a misura con taglio a 45°, squadrette di montaggio, pannello di fondo in alluminio composito, ferramenta necessaria, banner e gli occhielli esclusi. È possibile renderli luminosi aggiungendo moduli a Led e alimentatori.

*Solution to build monofacial boxes to stretch banner, realized with aluminum profiles, frame mm. 125x60, and easy klik-klak opening. Replacing the graphic is easy because the banner is stretched thanks to several spring hooks; it is enough to cut the banner and put common eyelets. Here you find a standard proposal with mounting kit. Kit includes: 45° cut tailored aluminum profiles, mounting brackets, bottom panel in composite aluminum, ironware; banner and eyelets are not included. It is possible to make them bright by adding led modules and power supplies.*

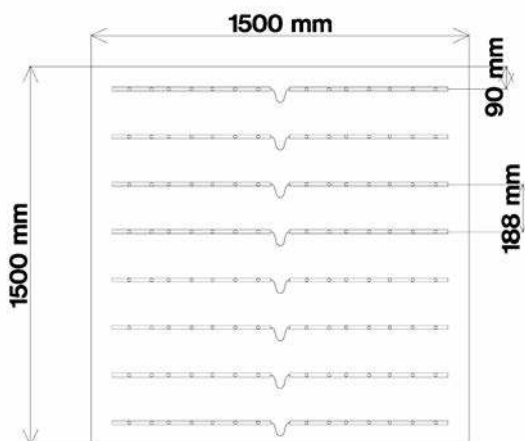

## SCHEDA TECNICA

Codice art.	Descrizione	Dimen. poster cm.	Dimen. esterne cm.	Dimen. visualiz. cm.	L.P.
EUBABL1515	kit struttura cm.150x150	150x150	152x152	140x140	950
Codice art.	Descrizione				L.P.
EUIEBABL1515	nr. 16 barre LED cm.63 + cablaggio + alimentatore 100w/24v				494

**ALTRE MISURE SU RICHIESTA**

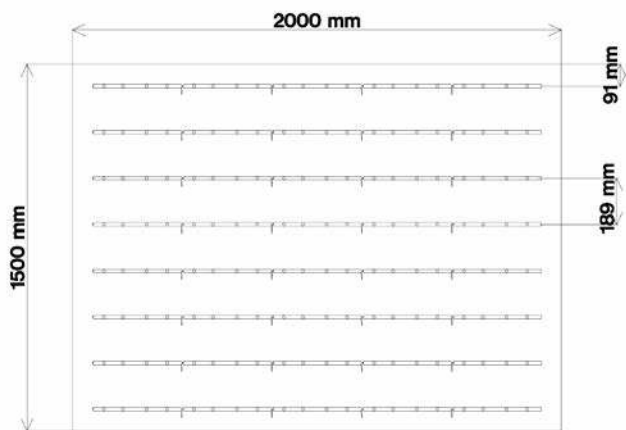

### SCHEDA TECNICA

Codice art.	Descrizione	Dimen. poster cm.	Dimen. esterne cm.	Dimen. visualiz. cm.	L.P.
EUBABL1520	kit struttura cm.150x200	150x200	152x202	140x190	1120

Codice art.	Descrizione	L.P.
EUIEBABL1520	nr. 40 barre LED cm.36 + cablaggio + alimentatore 2x100w/24v	734

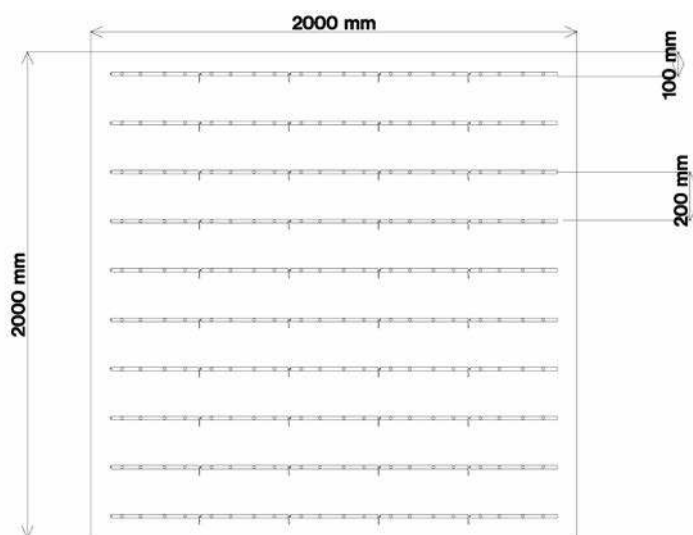

### SCHEDA TECNICA

Codice art.	Descrizione	Dimen. poster cm.	Dimen. esterne cm.	Dimen. visualiz. cm.	L.P.
EUBABL2020	kit struttura cm.200x200	200x200	202x202	190x190	1370

Codice art.	Descrizione	L.P.
EUIEBABL2020	nr. 50 barre LED cm.36 + cablaggio + alimentatore 2x100w/24v	1000

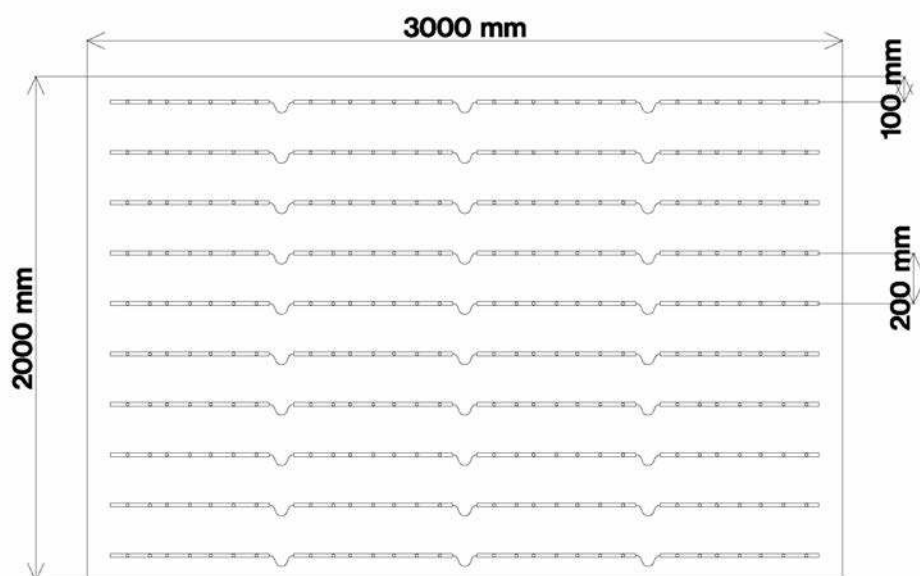

### SCHEDA TECNICA

Codice art.	Descrizione	Dimen. poster cm.	Dimen. esterne cm.	Dimen. visualiz. cm.	L.P.
EUBABL2030	kit struttura cm.200x300	200x300	202x302	190x290	1760

Codice art.	Descrizione	L.P.
EUIEBABL2030	nr. 40 barre LED cm.63 + cablaggio + alimentatore 2x100w/24v	1180

# CORNICI TEXTILE

**LED TECHNOLOGY**

Cornice in alluminio argento satinato monofacciale per tessuti, profondità profilo mm. 75 con illuminazione interna a led. Il cambio grafica è semplice e veloce grazie alla bandella in gomma da inserire lungo i bordi (non inclusa) che assicura un'ottima tensionatura del tessuto. Alimentatore Mean Well incluso.

*Satin silver aluminum monofacial frame for fabrics, profile depth mm. 75 with internal led light. Easy and fast graphic change thanks to the rubber seal to insert in the edges (not included) which ensures an excellent tensioning of the fabric. Mean Well power supply is included.*

## SCHEDA TECNICA TEXFRAME

Codice art.	Dimen. cm.	L.P.
CETEXFRA820	80x200	636
CETEXFRA1020	100x200	676
CETEXFRA1014	100x140	532
CETEXFRA1817	118,9x175	676
CERUBSE	Bandella in gomma mtl 33	38

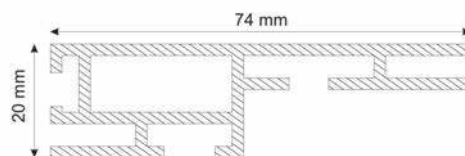
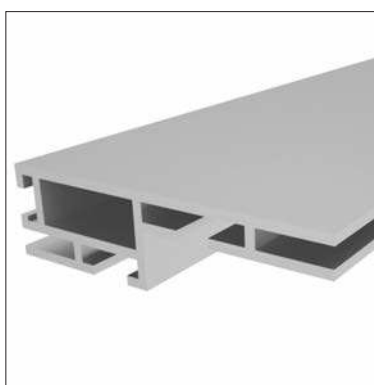

**ALIMENTATORE MEAN WELL**

**BANDELLA IN GOMMA (NON INCLUSA)**



# ECO LED BOX

Cornice luminosa a Led, realizzata in alluminio silver con profili da mm.25 ad apertura facilitata klik-klak, per un cambio grafica facile e veloce. Versione economica, è disponibile monofaciale nei vari formati. L'illuminazione perimetrale a Led, diffonde uniformemente la luce sulla superficie, dando gran risalto alle immagini esposte. Alimentatore Mean Well, completa questo articolo.

*LED frame realized with aluminum profiles thickness mm. 25 and klik-klak opening, for an easy and fast graphic replacement. Cheap version, is available monofacial in several sizes. The perimetric LED lighting diffuses evenly the bright on the surface, giving a great prominence to the graphics. Mean-Well power-supply included.*

**LED TECHNOLOGY**

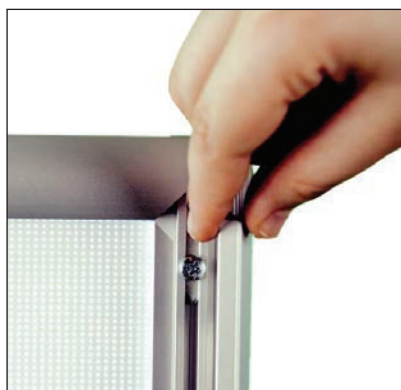

**ALIMENTATORE MEAN WELL**

## SCHEDA TECNICA

Cod. articolo	Dimen. poster cm.	Dimen. esterne cm.	Dimen. visualiz. cm.	L.P.
CEECOLBOXA4	21x29,7	24,2x32,9	19x27,7	120
CEECOLBOXA3	29,7x42	32,9x45,2	27,7x40	148
CEECOLBOXB3	35x50	38,2x53,2	33x48	203
CEECOLBOXB2	50x70	53,2x73,2	48x68	260
CEECOLBOXB1	70x100	73,2x103,2	68x98	396

# LITE LED BOX

Cornice luminosa a Led, realizzata in alluminio silver con profili ad apertura facilitata klik-klak, per un cambio grafica facile e veloce. Disponibile in vari formati nelle versioni monofacciale e bifacciale a sospensione. L'illuminazione perimetrale a Led, diffonde uniformemente la luce sulla superficie, dando gran risalto alle immagini esposte. Alimentatore Mean Well, completa questo articolo.

*LED frame realized with klik-klak silver aluminum profiles for an easy and fast graphic replacement. Available in several sizes both monofacial and bifacial for suspension mounting. The perimetric LED lighting diffuses evenly the bright in the surface, giving a great prominence to the graphics. Mean-Well power-supply included.*



**LED TECHNOLOGY**



CORNICI

104

## SCHEMA TECNICA LITE LEDBOX MONOFACCIALE

Codice art.	Dimen. poster cm.	Dimen. esterne cm.	Dimen. visualiz. cm.	L.P.
CELEBOXA4	21x29,7	25x33,7	19,6x28,3	146
CELEBOXA3	29,7x42	33,7x46	28,3x40,6	188
CELEBOXB3	35x50	39x54	33,6x48,6	217
CELEBOXB2	50x70	54x74	48,6x68,6	300
CELEBOXB1	70x100	74x104	68,6x98,6	502
CELEBOXB0	100x140	104x144	98,6x138,6	785

## BIFACCIALE

**LED TECHNOLOGY**



ALIMENTATORE MEAN WELL



## SCHEMA TECNICA LITE LEDBOX BIFACCIALE

Codice art.	Dimen. poster cm.	Dimen. esterne cm.	Dimen. visualiz. cm.	L.P.
CELEBOXA4B	21x29,7	23,5x32,2	17,6x26,3	242
CELEBOXA3B	29,7x42	32,2x44,5	26,3x38,6	310
CELEBOXB3B	35x50	37,5x52,5	31,6x46,6	338
CELEBOXB2B	50x70	52,5x72,5	46,6x66,6	483
CELEBOXB1B	70x100	72,5x102,5	66,6x96,6	734

# LITE **LED** BOX OUTDOOR

Cornice luminosa a Led, realizzata in alluminio silver con profili ad apertura facilitata klik-klak, per un cambio grafica facile e veloce. Disponibile in vari formati solo nella versione monofacciale, questo prodotto presenta gli adeguamenti necessari per la conformità IP67, come la guarnizione che troviamo intorno all'alloggiamento grafica e la connessione elettrica adeguata. L'illuminazione perimetrale a Led, diffonde uniformemente la luce sulla superficie, dando gran risalto alle immagini esposte. Alimentatore Mean Well, completa questo articolo.

*LED frame realized with klik-klak silver aluminum profiles for an easy and fast graphic replacement. Available in several sizes monofacial only, this product provides all the necessary adjustments for the IP67 compliance, as the gasket around the graphic placement and the appropriate electric connection. The perimetric LED lighting diffuses evenly the bright in the surface, giving a great prominence to the graphics. Mean-Well power-supply included.*

**LED TECHNOLOGY**



**ALIMENTATORE MEAN WELL**

## SCHEDA TECNICA

Codice art.	Dim. Poster	Dim. esterna cm.	Dim. visualizzabile cm.	L.P.
<b>CEOUTLEBOXA4</b>	21x29,7	26x347	17x25,7	277
<b>CEOUTLEBOXA3</b>	29,7x42	347x47	25,7x38	317
<b>CEOUTLEBOXB3</b>	35x50	40x55	31x46	375
<b>CEOUTLEBOXB2</b>	50x70	55x75	46x66	446
<b>CEOUTLEBOXB1</b>	70x100	75x105	66x96	625
<b>CEOUTLEBOXB0</b>	100x140	105x145	96x136	930
<b>CEOUTLEBOX1020</b>	100x200	105x205	96x196	1420
<b>CEOUTLEBOX1917</b>	118,9x175	123,9x180	114,9x171	1447

# SLIM LED BOX

Cornice luminosa a Led, ultrasottile, realizzata in alluminio silver con profili ad apertura facilitata klik-klak, per un cambio grafica facile e veloce.

Design pulito e lineare, questo prodotto è disponibile in vari formati nelle versioni monofacciali e bifacciale a sospensione. L'illuminazione perimetrale a Led, diffonde uniformemente la luce sulla superficie, dando gran risalto alle immagini esposte. Alimentatore Mean Well, completa questo articolo.

*Super-thin LED frame, realized with klik-klak silver aluminum profiles, for a fast and easy graphic replacement. With a linear and clean design, this product is available in several sizes both monofacial and bifacial for suspension mounting. The perimetric LED lighting diffuses the bright evenly on the surface, giving a great prominence to the graphics. 12V Mean-Well power-supply included.*

**LED TECHNOLOGY**

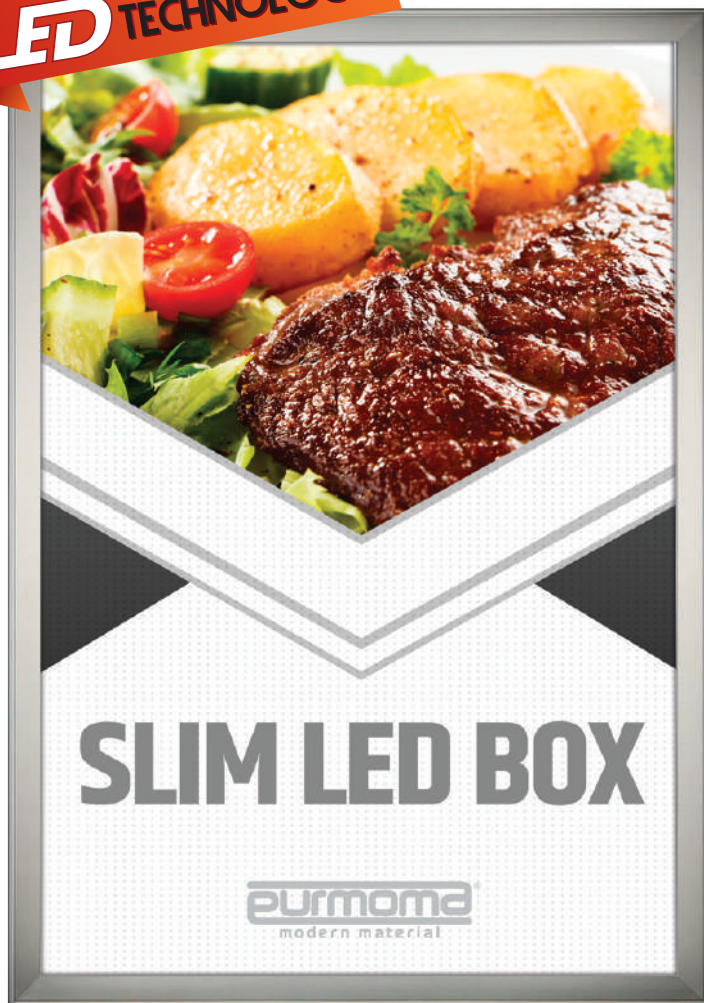

## SCHEDA TECNICA SLIM LEDBOX MONOFACCIALE

Codice art.	Dimen. poster cm.	Dimen. esterne cm.	Dimen. visualiz. cm.	L.P.
CESLLBOXA4	21x29,7	23,5x32,2	17,6x26,3	120
CESLLBOXA3	29,7x42	32,2x44,5	26,3x38,6	140
CESLLBOXB3	35x50	37,5x52,5	31,6x46,6	150
CESLLBOXB2	50x70	52,5x72,5	46,6x66,6	304
CESLLBOXB1	70x100	72,5x102,5	66,6x96,6	420

## BIFACCIALE



ALIMENTATORE MEAN WELL



## SCHEDA TECNICA SLIM LEDBOX BIFACCIALE

Codice art.	Dimen. poster cm.	Dimen. esterne cm.	Dimen. visualiz. cm.	L.P.
CESLLBOXA4B	21x29,7	23,5x32,2	17,6x26,3	260
CESLLBOXA3B	29,7x42	32,2x44,5	26,3x38,6	318
CESLLBOXB3B	35x50	37,5x52,5	31,6x46,6	351
CESLLBOXB2B	50x70	52,5x72,5	46,6x66,6	488
CESLLBOXB1B	70x100	72,5x102,5	66,6x96,6	668

# MAGNETO **LED** BOX

Cornice luminosa a Led, ultrasottile, solo 15mm. di spessore, cambio grafica facile e veloce grazie al pannello frontale magnetico; presenta un passapartout frontale nero che esalta l'immagine esposta. Disponibile in vari formati nelle versioni monofacciali e bifacciali a sospensione. L'illuminazione perimetrale a Led, diffonde uniformemente la luce sulla superficie, dando gran risalto alle immagini esposte. Alimentatore 12 Volt Mean Well, completa questo articolo.

*LED frame with super-thin profile mm. 15 thickness, easy and fast graphic replacement thanks to the magnetic front panel; it provides a front black skeleton-key which enhance the graphic. It is available in several sizes and both monofacial and bifacial for suspension mounting. The perimetric LED lighting diffuses evenly the bright on the surface, giving a great prominence to the graphics. Mean-Well 12V power-supply included.*



## SCHEDA TECNICA MAGNETO LEDBOX MONOFACCIALE

Codice art.	Dimen. poster cm.	Dimen. esterne cm.	Dimen. visualiz. cm.	L.P.
CEMAGA4	21x29,7	23,5x32,2	17x25,7	152
CEMAGA3	29,7x42	32,2x44,5	25,7x38	204
CEMAGB3	35x50	37,5x52,5	31x46	242
CEMAGB2	50x70	52,5x72,5	46x66	320
CEMAGB1	70x100	72,5x102,5	66x96	503

## BIFACCIALE



ALIMENTATORE MEAN WELL



## SCHEDA TECNICA MAGNETO LEDBOX BIFACCIALE

Codice art.	Dimen. poster cm.	Dimen. esterne cm.	Dimen. visualiz. cm.	L.P.
CEMAGBIA4	21x29,7	23,5x32,2	17x25,7	260
CEMAGBIA3	29,7x42	32,2x44,5	25,7x38	332
CEMAGBIB3	35x50	37,5x52,5	31x46	374
CEMAGBIB2	50x70	52,5x72,5	46x66	552
CEMAGBIB1	70x100	72,5x102,5	66x96	900



# MOONLIGHT LED BOX

Cornice luminosa a Led, realizzata in alluminio silver o nera con profili ad apertura facilitata klik-klak, per un cambio grafica facile e veloce. Disponibili monofacciali nei formati B1 e B0. Questo prodotto presenta una doppia illuminazione: interna con luce bianca per la grafica, esterna laterale di vari colori, selezionabili da telecomando in dotazione. Alimentatore 12 Volt Mean Well, completa questo articolo.

*LED frame realized with klik-klak silver or black profiles, for an easy and fast graphic replacement. It is available monofacial in B1 and B0 sizes. This product provides a double lighting: one internal with white light for the graphic, the other external in several colours customizable by the remote control included. 12V Mean-Well power-supply included.*



ALIMENTATORE MEAN WELL

## SCHEDA TECNICA

Codice art.	Colore	Dimen. poster cm.	Dimen. esterne cm.	Dimen. visualiz. cm.	L.P.
CEMOONBOXB1S	Silver	70x100	72,7x102,7	64,2x94,2	854
CEMOONBOXB0S	Silver	100x140	102,7x142,7	94,2x134,2	1316
CEMOONBOXB1N	Nera	70x100	72,7x102,7	64,2x94,2	854
CEMOONBOXB0N	Nera	100x140	102,7x142,7	94,2x134,2	1316



# MOONLIGHT MAGNETO LED

Cornice luminosa a Led, cambio grafica facile e veloce grazie al pannello frontale magnetico; presenta un passe-partout frontale nero che esalta l'immagine esposta. Disponibile monofacciale in vari formati. Questo prodotto presenta una doppia illuminazione: interna con luce bianca per la grafica, esterna posteriore di vari colori, selezionabili da telecomando in dotazione. È corredata di distanziali per il fissaggio a parete. Alimentatore 12 Volt Mean Well, completa questo articolo.

*Led frame with easy and fast graphic replacement thanks to the magnetic front panel; it provides a front black skeleton-key which enhance the graphic. It is available monofacial in several sizes. This product provides a double lighting: one internal with white light for the graphic, the other external in several colours customizable by the remote control included. It provides also spacers for the wall mounting. 12V Mean-Well power-supply included.*



ALIMENTATORE MEAN WELL

## SCHEDA TECNICA

Codice art.	Dimen. poster cm.	Dimen. esterne cm.	Dimen. visualiz. cm.	L.P.
CEMOOMAGA4	21x29,7	23,5x32,2	17x25,7	288
CEMOOMAGA3	29,7x42	32,2x44,5	25,7x38	352
CEMOOMAGB3	35x50	37,5x52,5	31x46	394
CEMOOMAGB2	50x70	52,5x72,5	46x66	588
CEMOOMAGB1	70x100	72,5x102,5	66x96	940





# CAVALLETTI

ESPOSITORI CAVALLETTO  
A&B DISPLAY HD  
ECO EXPO KLIK-KLAK  
CAVALLETTO COMPACT  
CAVALLETTO SLIDE  
AVENUE  
SQUARE  
CAVALLETTO ART  
CAFÈ BARRIER  
NEW BISTRÒ  
RISTO IN ALLUMINIO  
CAVALLETTI LAVAGNA  
NEW ELIMINACODE  
BORDOCAMPO METAL  
BORDOCAMPO PLAST

# ESPOSITORI CAVALLETTO

Espositore realizzato in polipropilene alveolare bianco, ultraleggero, resistente e dal facile montaggio. Adatto per applicare manifesti già stampati o come supporto per pellicole adesive stampate in digitale; viene proposto in due differenti versioni, Classic e New.

*Exhibitor made of honeycomb polypropylene white, lightweight, durable and easy installation. Suitable to apply posters already printed or as support for adhesive films digitally printed; It is available in two different versions, Classic and New.*



**NEW**

**CLASSIC**



## SCHEDA TECNICA ESPOSITORE CAVALLETTO NEW

Codice art.	Misure cm.	Poster cm.	Spessore mm.	L.P.
EUCAV5070	50x85	50x70	10	44
EUCAV70100	70x115	70x100	10	66
EUCAV100140	100x150	100x140	10	110

## SCHEDA TECNICA ESPOSITORE CAVALLETTO CLASSIC

Codice art.	Misure cm.	Poster cm.	Spessore mm.	Quantità minima	L.P.
EUESCAV1520	15x25	15x20	5	37	5
EUESCAV1725	17,5x30	17,5x25	5	22	7
EUESCAV2030	20x35	20x30	5	20	8
EUESCAV2435	24x41	24x35	5	12	9
EUESCAV3040	30x46	30x40	5	10	12
EUESCAV3550	35x57,5	35x50	5	8	14
EUESCAV5070	50x85	50x70	10	1	44
EUESCAV710	70x115	70x100	10	1	66
EUESCAV1014	100x150	100x140	10	1	110



# A & B DISPLAY HD

Cavalletto in PVC-HD bianco da mm. 5 di spessore, incernierato nella parte superiore per una facile apertura; adatto per grafiche digitali o scritte prespaziate. Viene proposto in due differenti versioni.

*Trestle PVC - HD white mm. 5 thick, hinged at the top for easy opening; suitable for digital graphics or pre-spaced written. It is offered in two different versions.*



**BB  
DISPLAY**



**AA  
DISPLAY**



## SCHEDA TECNICA AA DISPLAY HD

Codice art.	Misure est. cm.	Grafica cm.	Imballo cm.	Peso Kg.	L.P.
EUAADISHD57	50x87	50x70	60x75x6	5	75
EUAADISHD68	60x87	60x80	62x97x6	8	95
EUAADISHD710	70x117	70x100	72x117x6	12	165
EUAADISHD1014	100x148	100x140	110x150x6	15	225

## SCHEDA TECNICA BB DISPLAY HD

Codice art.	Misure est. cm.	Grafica cm.	Imballo cm.	Peso Kg.	L.P.
EUBBDISHD57	50x80	50x70	60x75x6	5	75
EUBBDISHD68	60x93	60x80	62x97x6	8	95
EUBBDISHD710	70x113	70x100	72x117x6	12	165
EUBBDISHD1014	100x148	100x140	110x150x6	15	225

# ECO EXPO KLIK KLAK

Espositore Klik Klak bifacciale in alluminio anodizzato silver, con angoli a 45° e spessore profilo mm. 25; è confezionato singolarmente con manuale di montaggio incluso.

*Exhibitor Klik Klak sided anodized aluminum silver, with angles of 45° and thickness profile mm. 25; it is packed with assembly instructions included.*

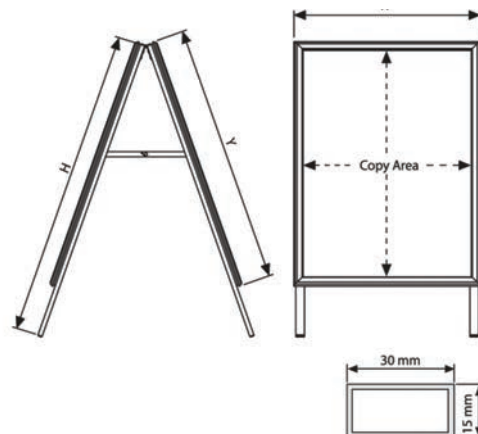
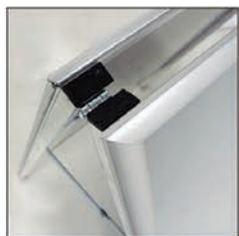

## FOGLI ANTIRIFLESSO DI RICAMBIO

Codice art.	Descrizione	Formato cm.	Spess. my	L.P.
KKPVM305070	Antiriflesso 300	50x70	300	3
KKPVM307010	Antiriflesso 300	70x100	300	6
KKPVM501014	Antiriflesso 500	100x140	500	19

## SCHEDA TECNICA

Codice art.	Misure cm.	Cornice cm.	Poster cm.	Imballo cm.	Peso Kg.	L.P.
MTECOEXKKKB2	50x95	53x73	50x70	62x108x8	8	102
MTECOEXKKKB1	70x120	73x103	70x100	80x139x8	12	142
MTECOEXKKB0	100x160	103x143	100x140	110x179x8	14	266

# CAVALLETTO COMPACT

Cavalletto bifacciale in alluminio anodizzato silver, con rapido cambio grafica grazie alle scanalature in cui viene inserito il pannello in PVC, di spessore mm. 3. (Non incluso).

*Double sided anodized aluminum silver trestle, with quick change graphic thanks to grooves in which the panel is inserted in PVC, thickness mm. 3. (Not included).*



## SCHEMA TECNICA

Codice art.	Misure cm.	Cornice cm.	Poster cm.	Imballo cm.	L.P.
MTCACOB2	54x95	53x73	50x70	11,5x102x6,5	80
MTCACOB1	74x125	73x103	70x100	11,5x132x6,5	90

# CAVALLETTO SLIDE

Cavalletto realizzato in alluminio nero, con apertura superiore mediante un profilo snap, per un cambio grafica veloce e semplice; il poster si inserisce tra il pannello di fondo ed il film protettivo frontale. Disponibile in 2 formati A1 (cm.59,4x84,1) e B1 (cm.70x100).

*Easel made of black aluminum, with top opening through snap profile for an easy and fast graphic replacement; poster must be inserted between the bottom panel and the protective front film. Available in two different sizes A1 (cm. 59,4x84,1) e B1 (cm. 70x100).*



## SCHEMA TECNICA

Codice art.	Dim. grafica cm.	Dim. esterne cm.	Altezza cm.	L.P.
MTCASLIDEA1	59,4x84,1	65,1x90,7	115	186
MTCASLIDEB1	70x100	75,7x106,6	125	222

# AVENUE

Cavalletto in alluminio bifacciale, composto da due cornici klik klak montate su piedi in acciaio verniciato grigio. Le molle garantiscono un'ottima stabilità assorbendo la spinta del vento.

*Aluminum double-sided trestle, two frames klik Klak mounted on feet in grey painted steel. The springs provide excellent stability by absorbing the force of the wind.*

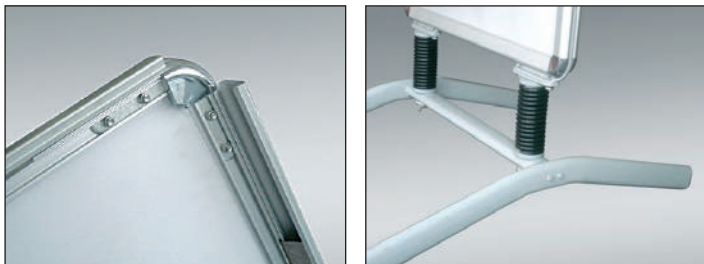

## FOGLI ANTIRIFLESSO DI RICAMBIO

Codice art.	Descrizione	Formato cm.	Spess. my	L.P.
KKPVM307010	Antiriflesso 300	70x100	300	6

## SCHEDA TECNICA

Codice art.	Cornice cm.	Pannello cm.	Peso Kg.	L.P.
DWAVEA1	64x90	58x83,7	14	190
DWAVEB1	75x105	70x100	14	270

# SQUARE

Cavalletto con cornice klik klak bifacciale in alluminio anodizzato, con base in plastica antiurto riempibile con acqua o sabbia per aumentarne la stabilità. Grazie al manico ed alle ruote, si sposta molto facilmente.

*Trestle with frame klik Klak double-sided anodized aluminum base with shockproof plastic fillable with water or sand for added stability. Thanks to the handle and wheels, it moves very easily.*

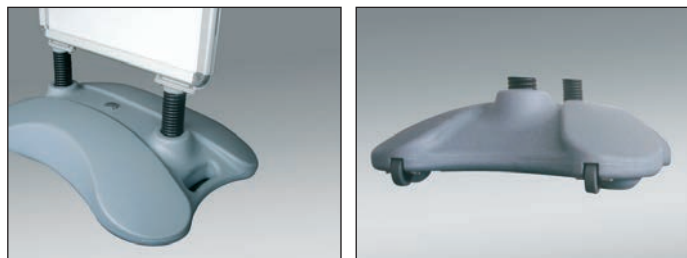

## FOGLI ANTIRIFLESSO DI RICAMBIO

Codice art.	Descrizione	Formato cm.	Spess. my	L.P.
KKPVM307010	Antiriflesso 300	70x100	300	6

## SCHEDA TECNICA

Codice art.	Cornice cm.	Grafica cm.	L.P.
DWSQUA1	65x89,5	58x83,7	210
DWSQUB1	75x105	70x100	280

# CAVALLETTO ART IN LEGNO

Cavalletto realizzato in legno, regolabile, in grado di ospitare grafiche dal formato B2 (cm. 50x70.7) al formato A0 (84.1x118.9). Il supporto posteriore regolabile assicura la stabilità ed un comodo utilizzo nelle diverse angolazioni. È disponibile anche con morsetto in cima per tenere salda la cornice. Si richiude in modo uniforme così da essere trasportato e deposto in modo pratico veloce.

*Trestle made of wood, adjustable, it can includes graphics from B2 format (cm. 50x70.7) to A0 (84.1x118.9). The adjustable back support ensures stability and a comfortable use in different angles. It is also available with clamp on the top to keep a steady frame. It closes in an uniform manner so as to be transported and deposited in a practical and fast way .*

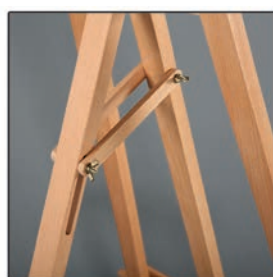

## SCHEMA TECNICA CAVALLETTO ART IN LEGNO CON MORSETTO

Codice art.	Misure cm.	Peso Kg.	Imballo cm.	L.P.
MTNEWCALEMO	55.5x62x14.6	5.5	28.5x12.5x24.5	130

## SCHEMA TECNICA CAVALLETTO ART IN LEGNO

Codice art.	Misure cm.	Peso Kg.	Imballo cm.	L.P.
MTNEWCALE	61x108x150	5.5	22.5x154.5x22.5	130

# CAFE' BARRIER

Struttura autoportante in cromo lucido, con possibilità di posizionare un banner pubblicitario. È composta da piantana con ghiere a quattro agganci per il fissaggio a moschettone delle barre orizzontali di sostegno per la grafica, di diametro mm. 32.

*Standing structure in polished chrome, with the possibility of placing an advertising banner. It is composed of a floor lamp with four hooks ferrules for fixing to the snap-hook of the horizontal bars of support for graphics, diameter mm. 32.*



Asola	cm.11
Spazio grafica	cm.80
Asola	cm.11
cm.130	

## SCHEMA TECNICA

Codice art.	Misure cm.	Grafica cm.	L.P.
YACABABA	90+5 (colonna + piantana)	130x70	90
YACABAPO	150 (barra orizz.), ø 3,2		40

# NEW BISTRO' in legno

Serie di cavalletti in legno, particolarmente indicati per il settore della ristorazione; bifacciali, si presentano con struttura in legno massello, disponibili in unico formato e in due tinte, classica color legno e nera con testata tonda. Entrambe le soluzioni posso essere usate anche in esterno.

*Wood easels for restaurants, bifacial, structure made of solid wood, available in only one size in two colours, classic wood and black with round headboard. Both the solutions can be used outdoor too.*



## SCHEDA TECNICA

Codice art.	Descrizione	Dim. grafica cm.	Dim. esterne cm.	Dimen. visualiz. cm.	L.P.
MTBILE7090	Cavalletto legno classico	60x78	70x105,5	60x78	245
CEBIBL	Cavalletto legno nero	60x80	70x102	60x80	190

# RISTO in alluminio

Cavalletto composto da profili in alluminio anodizzato con effetto legno; è utilizzabile sia con gessetti che con pennarelli gesso liquido.

*Trestle consists of anodized aluminum with wood effect; it is usable both with chalks and with chalk markers.*

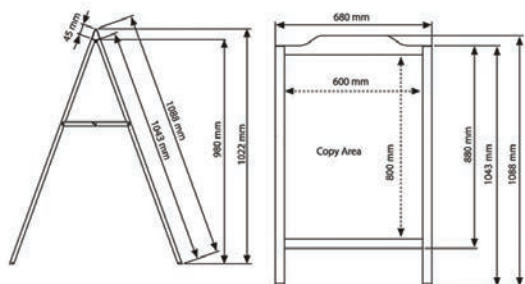
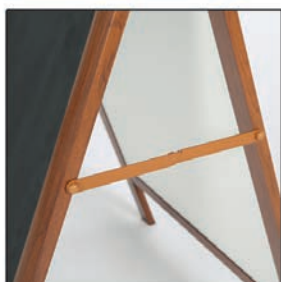

## SCHEDA TECNICA

Codice art.	Misure cm.	Cornice cm.	Grafica cm.	Tipologia	L.P.
MTRIAL6080	68x108,8	68x88	60x80	Con testata	270

# CAVALLETTI LAVAGNA

Serie di cavalletti realizzati in alluminio, richiudibili, per uso esterno. Sono disponibili con struttura di colore silver o nero, con pannello scrivibile bianco o nero. Facilmente cancellabili, sono scrivibili solo con pennarelli deletibili. Disponibili in unico formato cm.60x80.

*Easels realized in aluminum, resealable, for indoor use. They are available with silver or black structure, with writable white or black panel. Easily erasable, they are writable only with erasable markers. Available in the size cm. 60x80 only.*



## SCHEMA TECNICA

Codice art.	Descrizione	Dim. grafica cm.	Dim. esterne cm.	Altezza cm.	L.P.
MTCALASVNE	Cavalletto lavagna silver pannelli neri	60x80	63,5x85,3	115	188
MTCALASVBI	Cavalletto lavagna silver pannelli bianchi	60x80	63,5x85,3	115	188
MTCALANENE	Cavalletto lavagna nero pannelli neri	60x80	63,5x85,3	115	186
MTCALANEBI	Cavalletto lavagna nero pannelli bianchi	60x80	63,5x85,3	115	186

# NEW ELIMINACODE

Sistema per organizzare gli spazi ed i flussi di persone, disponibile a scelta in diverse colorazioni e configurazioni sia ad aggancio singolo che doppio. È possibile abbinare accessori come gli attacchi da muro, le cassette di ricambio e le staffe portamessaggi. Il palo è alto cm. 91 e la base ha un diametro di cm. 32.

*Solution to organize spaces and people available in different colours and configurations, with both single and double hooking. It is possible to add accessories like wall fixing, replacement tapes and pockets. The pole is 91 cm. high and the base has a diameter of 32 cm.*

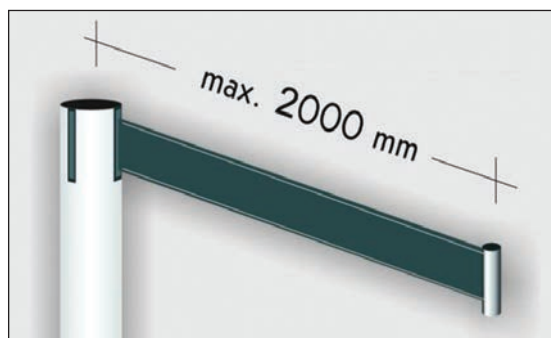

## SCHEDA TECNICA NASTRO SINGOLO

Codice art.	Descrizione	Colore nastro	L.P.
YALCONN	Nastro singolo	Nero	120
YALCONR	Nastro singolo	Rosso	120
YALCONB	Nastro singolo	Blu	120



## SCHEDA TECNICA CLASSIC

Codice art.	Descrizione	Colore	L.P.
YAECSO	Palo + base	Cromo silver	150
YAECSOGLD	Palo + base	Cromo oro	150
YACOROCROSIL	Corda lungh. cm. 150 per palo e base cromo silver	Rossa	50
YACOROCROGLD	Corda lungh. cm. 150 per palo e base cromo oro	Rossa	50
YACOBLCROSIL	Corda lungh. cm. 150 per palo e base cromo silver	Blu	50
YACOBLCROGLD	Corda lungh. cm. 150 per palo e base cromo oro	Blu	50



# NEW ELIMINACODE

Sistema per organizzare gli spazi ed i flussi di persone, disponibile a scelta in diverse colorazioni e configurazioni sia ad aggancio singolo che doppio. È possibile abbinare accessori come gli attacchi da muro, le cassette di ricambio e le staffe portamessaggi. Il palo è alto cm. 91 e la base ha un diametro di cm. 32.

*Solution to organize spaces and people available in different colours and configurations, with both single and double hooking. It is possible to add accessories like wall fixing, replacement tapes and pockets. The pole is 91 cm. high and the base has a diameter of 32 cm.*

## SCHEDA TECNICA NASTRO DOPPIO

Codice art.	Descrizione	Colore nastro	L.P.
YAEFC02NN	Nastro doppio	Nero	160
YAEFC02NR	Nastro doppio	Rosso	160
YAEFC02NB	Nastro doppio	Blu	160



LUNGHEZZA MAX CM 200

## SCHEDA TECNICA RICAMBIO CASSETTA NASTRO

Codice art.	Descrizione	Colore nastro	L.P.
YAAVNN	Ricambio cassetta nastro	Nero	40
YAAVNR	Ricambio cassetta nastro	Rosso	40
YAAVNB	Ricambio cassetta nastro	Blu	40



## SCHEDA TECNICA BLOCCA CODE DA MURO

Codice art.	Descrizione	Colore nastro	L.P.
YAELMUNN	Blocca code da muro, cromato	Nero	70
YAELMUNR	Blocca code da muro, cromato	Rosso	70
YAELMUNB	Blocca code da muro, cromato	Blu	70



TASCA ANGOLO 45°



TASCA ANGOLO TONDO



STAFFA



## SCHEDA TECNICA STAFFE E TASCHE

Codice art.	Descrizione	Dim. esterne cm.	Grafica cm.	L.P.
YAPOMEA445	Staffa con tasca angoli 45°	24x33	20x29	60
YAPOMEA44T	Staffa con tasca angoli tondi	26x34	22,5x30,5	66
YAPOMESTA	Staffa per pannello	20		60

# BORDOCAMPO METAL

Struttura bifacciale con telaio in alluminio anodizzato, a sezione quadra da mm. 25 per pannelli in pvc espanso di spessore mm. 5.

Le cerniere consentono un'apertura ed una chiusura rapide e facili.

*Double Sided structure with anodized aluminum frame, square section from mm. 25 for panels PVC foam thickness mm. 5. The hinges allow an opening and closing quick and easy.*

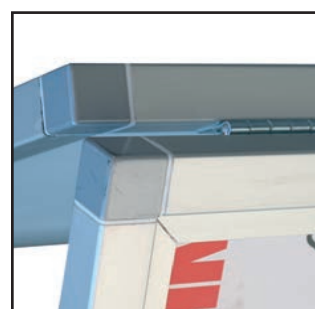

## SCHEDA TECNICA

Codice art.	Dim. Esterne cm.	Grafica cm.	L.P.
EUBOCAME7520	80,4x210	75x200	320
EUBOCAME1020	105,4x210	100x200	350
EUBOCAME7530	80,4x310	75x300	400
EUBOCAME1030	105,4x310	100x300	440

# BORDOCAMPO PLAST

Struttura bifacciale in polionda alveolare bianco di spessore mm. 8, sezione triangolare, con pre-inciisioni che facilitano la piega per il posizionamento; la chiusura è garantita dal biadesivo posizionato sul lato inferiore. Disponibile in quattro differenti versioni.

*Double-Sided corrugated honeycomb structure in white mm 8 thick, triangular section, with pre- incisions which facilitate the fold for placement; the closure is guaranteed by the double-sided adhesive positioned on the lower side. Available in four different versions.*



## SCHEDA TECNICA

Codice art.	Misure cm.	Cornice cm.	L.P.
EUBOCAPLA	300x90	300x90	100
EUBOCAPLB	300x87	300x87	100
EUBOCAPLC	300x102	300x102	100
EUBOCAPLD	300x98	300x98	100

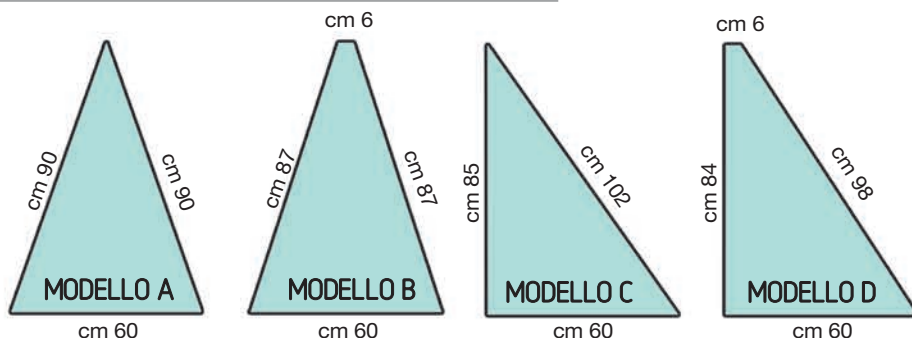



# ESPOSITORI

da banco  
da parete  
da pavimento  
da vetro

INFOEXPO & INFOEXPO  
STYLE  
INFOTASCA  
SEGNAPOSTI  
EXPOPLEX ECONOMY  
EXPOPLEX DA  
BANCO/PARETE  
TASCA VISION  
WALL UNIT  
PLEX BOX  
METAL DEPLIANT  
STEEL DEPLIANT  
US PLEX BOX  
ZICK-ZACK

VELAPLEX  
CLEAR FRAME  
SERIE PODIO  
CESTO GLOBE  
DUAL PLATE  
TOURIST SIGNAL  
AUTOMOTIVE  
FLEXIBLE  
FLEXIBLE LED  
ZETA PERSPEX  
ELLE PERSPEX  
SLIM DEPLIANT & SLIM  
INFO

# INFOEXPO & INFOEXPO STYLE

Tasca porta messaggi da banco, disponibile sia verticale che orizzontale, realizzata in Perspex trasparente, sagomata e tagliata a filo lucido mediante tecnologia laser. La leggera inclinazione permette una migliore visibilità dei messaggi esposti, che possono essere velocemente sostituiti.

*Pocket messages over the counter, available in both vertical and horizontal, made of transparent Perspex, contoured cut and polished edge by laser technology. The slight tilt allows for better visibility of the messages display, which can be quickly.*

## SCHEDA TECNICA INFOEXPO

Codice art.	Dimensioni cm	L.P.
EUEAB1015	Verticale 10x15	5
EUEAB1021	Verticale 10x21	6
EUEAB1521	Verticale 15x21	8
EUEAB2130	Verticale 21x30	12
EUEAB3040	Verticale 30x40	23
EUEAB1510	Orizzontale 15x10	5
EUEAB2110	Orizzontale 21x10	6
EUEAB2115	Orizzontale 21x15	8
EUEAB3021	Orizzontale 30x21	12
EUEAB4030	Orizzontale 40x30	23
EUEAB2130PB	Verticale 21x30 + Portabrochure 1/3 A4	30

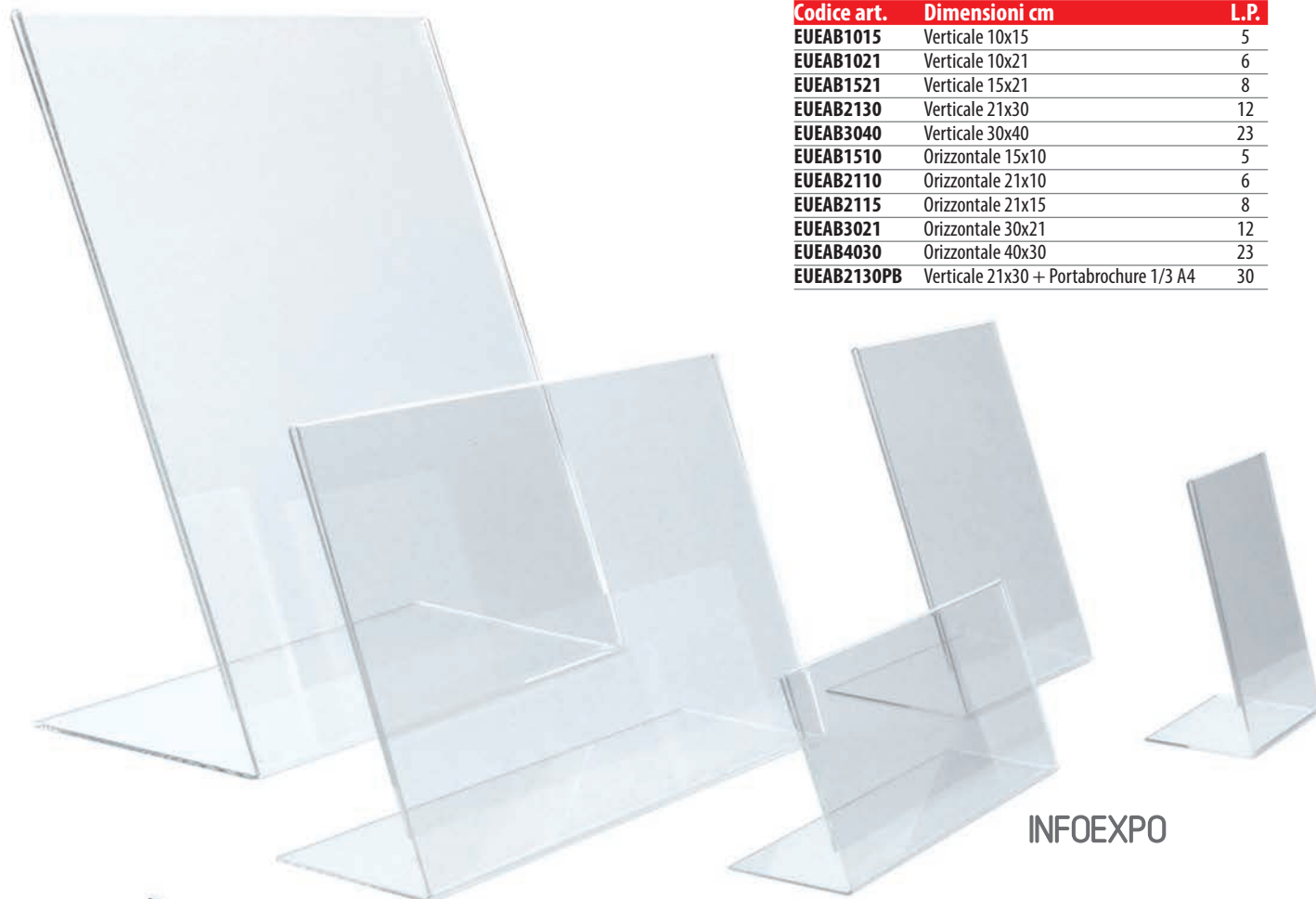

INFOEXPO

Espositore da banco in Perspex dal design semplice ed elegante, disponibile nelle varianti trasparente, nero lucido e fumè grigio. Contiene molti depliant o cataloghi.

*Counter display made of Perspex available in transparent, black and fumè finishing. It contains several catalogues and depliant.*



INFOEXPO STYLE

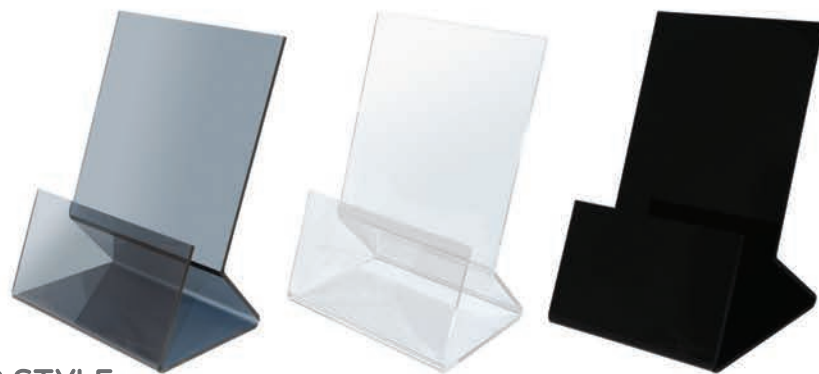

## SCHEDA TECNICA INFOEXPO STYLE

Codice art.	Colore	Formato	L.P.
EUEPRA4VTR	Trasparente	A4 verticale cm. 21x29,7	18
EUEPRA4VFU	Fumè grigio	A4 verticale cm. 21x29,7	18
EUEPRA4VNE	Nero lucido	A4 verticale cm. 21x29,7	18
EUEPRA5VTR	Trasparente	A5 verticale cm. 14,8x21	12
EUEPRA5VFU	Fumè grigio	A5 verticale cm. 14,8x21	12
EUEPRA5VNE	Nero lucido	A5 verticale cm. 14,8x21	12

# INFOTASCA

Tasca porta messaggi da banco, disponibile sia verticale che orizzontale, realizzata in Perspex trasparente, sagomata e tagliata a filo lucido mediante tecnologia laser. È ideale per l'esposizione di messaggi, che possono essere velocemente sostituiti.

*Pocket messages over the counter, available in both vertical and horizontal, made of transparent Perspex, contoured cut and polished edge by laser technology. It is ideal for the display of messages, which can be quickly replaced.*

## SCHEMA TECNICA

Codice art.	Dimensioni cm.	L.P.
EUECD1015	Verticale 10x15	9
EUECD1021	Verticale 10x21	10
EUECD1521	Verticale 15x21	11
EUECD2130	Verticale 21x30	16
EUECD3040	Verticale 30x40	26
EUECD1510	Orizzontale 15x10	9
EUECD2110	Orizzontale 21x10	10
EUECD2115	Orizzontale 21x15	12
EUECD3021	Orizzontale 30x21	16
EUECD4030	Orizzontale 40x30	26



# SEGNAPOSTI

Cavalletto da tavolo per l'assegnazione dei posti, realizzato in Perspex trasparente lucido mediante tecnologia laser; riutilizzabile grazie al veloce cambio grafica.

*Trestle table for the allocation of seats, made of transparent Perspex polished by laser technology; Reusable thanks to the fast changing graphics.*

## SCHEMA TECNICA

Codice art.	Dimensioni cm.	L.P.
EUECAV55	5,5x5,5	4
EUECAV101	10x10	5
EUECAV125	12x5	5
EUECAV156	15x6	5
EUECAV186	18x6	8
EUECAV207	20x7	8
EUECAV201	20x10	8
EUECAV218	21x8	10
EUECAV211	21x10	10
EUECAV258	25x8	12
EUECAV301	30x10	12

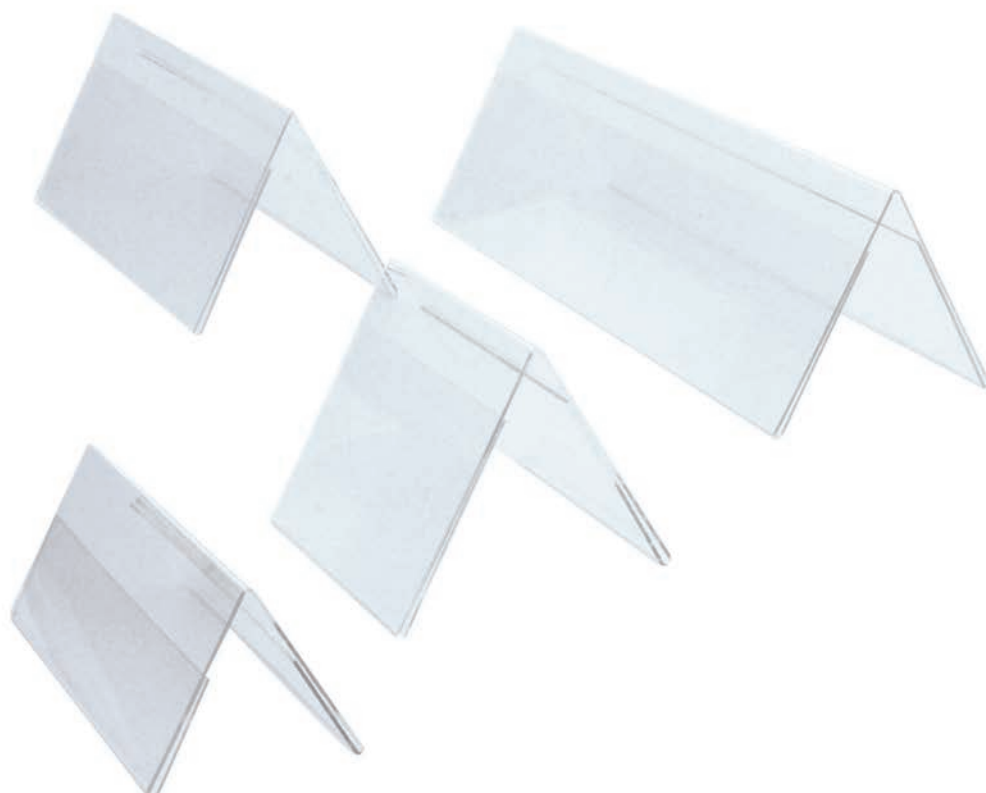

## DA BANCO

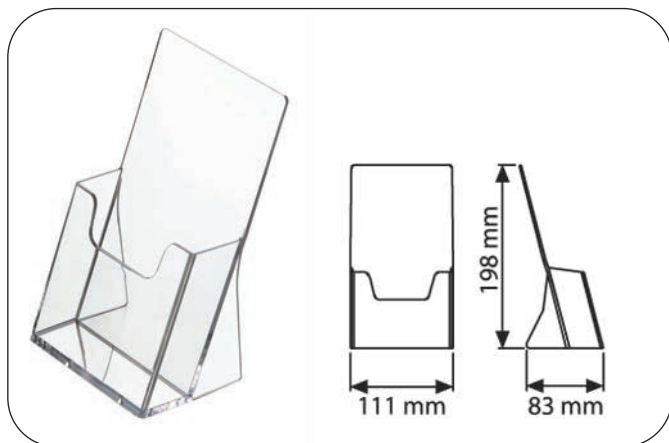

Codice art.	Descrizione	L.P.
MTC110	Portabrochure da banco 1 f.to 1/3 di A4 cm. 10x21	3,00

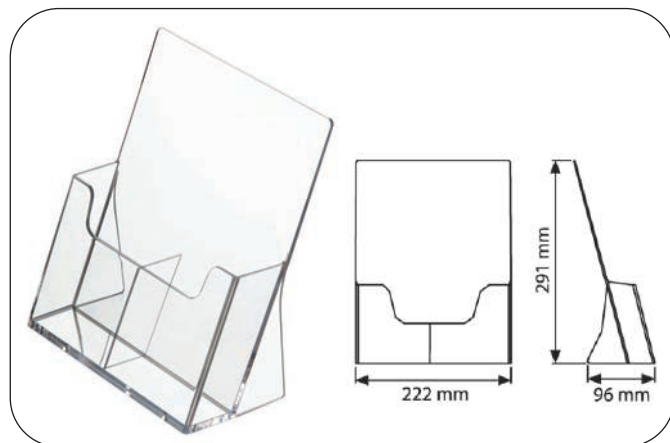

Codice art.	Descrizione	L.P.
MTC112	Portabrochure da banco 2 f.ti 1/3 di A4 cm. 10x21	7,00

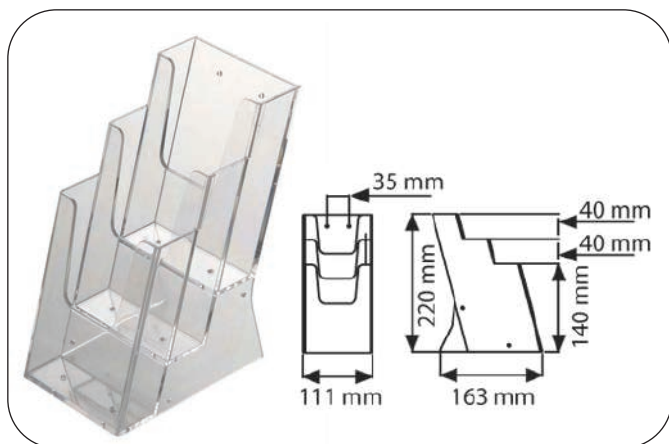

Codice art.	Descrizione	L.P.
MT3C104	Portabrochure da banco 3 f.ti 1/3 di A4 cm. 10x21	8,00

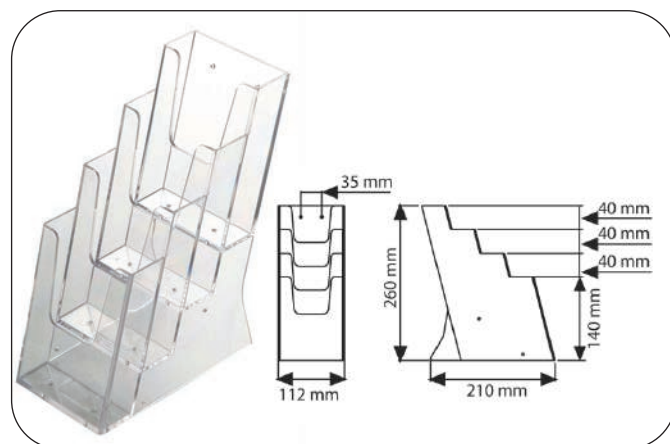

Codice art.	Descrizione	L.P.
MT4C110	Portabrochure da banco 4 f.ti 1/3 di A4 cm. 10x21	10,00

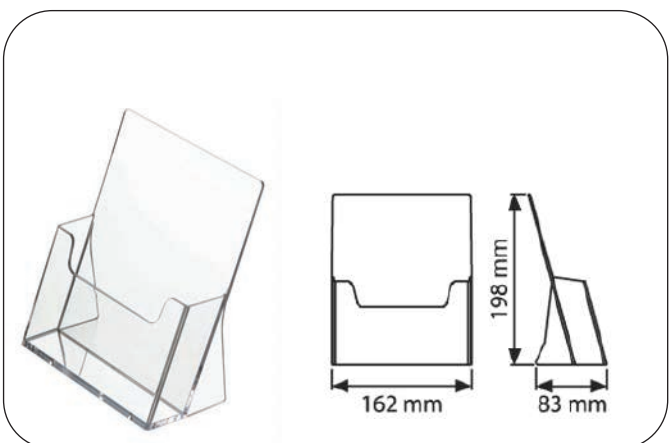

Codice art.	Descrizione	L.P.
MTC160	Portabrochure da banco 1 f.to A5 cm. 15x21	4,00

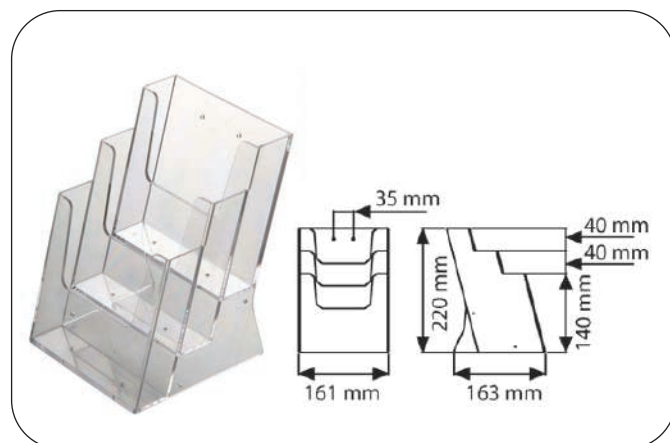

Codice art.	Descrizione	L.P.
MT3C160	Portabrochure da banco 3 f.ti A5 cm. 15x21	10,00

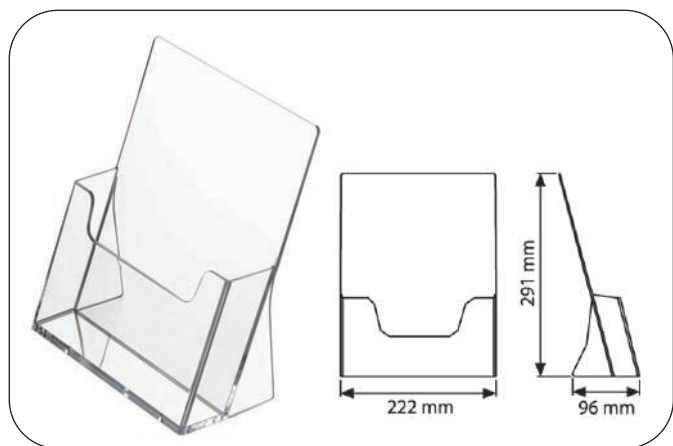

Codice art.	Descrizione	L.P.
MTC230	Portabrochure da banco 1 f.to A4 cm. 21x29,7	7,00

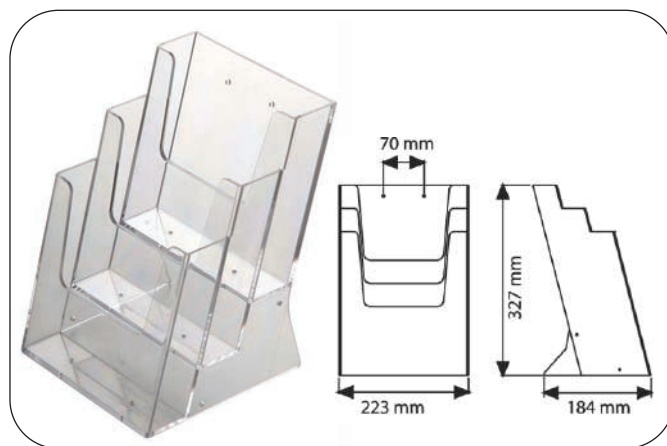

Codice art.	Descrizione	L.P.
MT3C230	Portabrochure da banco 3 f.ti A4 cm. 21x29,7	25,00

## DA PARETE

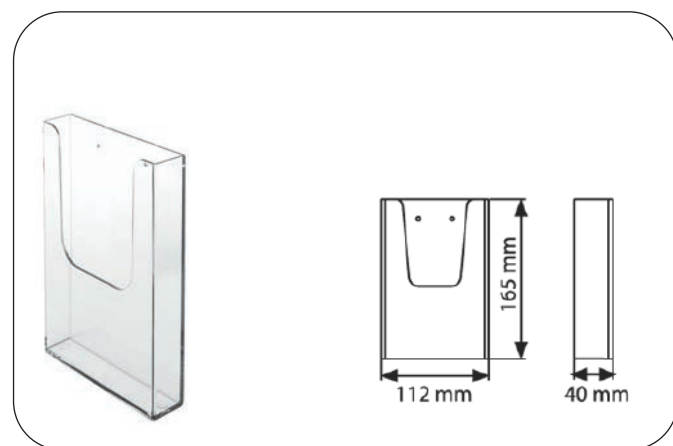

Codice art.	Descrizione	L.P.
MTW110	Portabrochure da parete 1 f.to 1/3 di A4 cm. 10x21	3,00

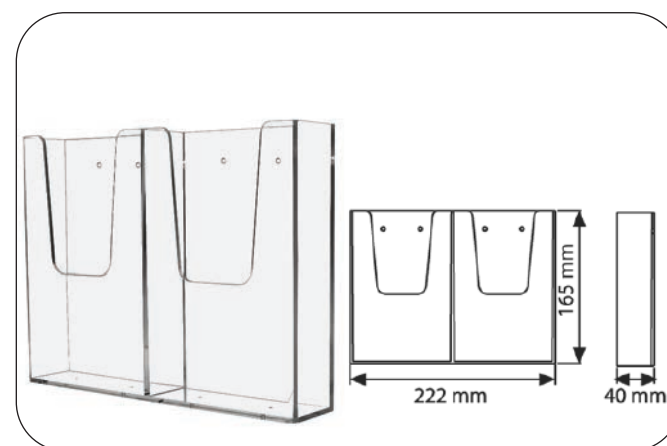

Codice art.	Descrizione	L.P.
MT2W110	Portabrochure da parete 2 f.ti 1/3 di A4 cm. 10x21	5,00

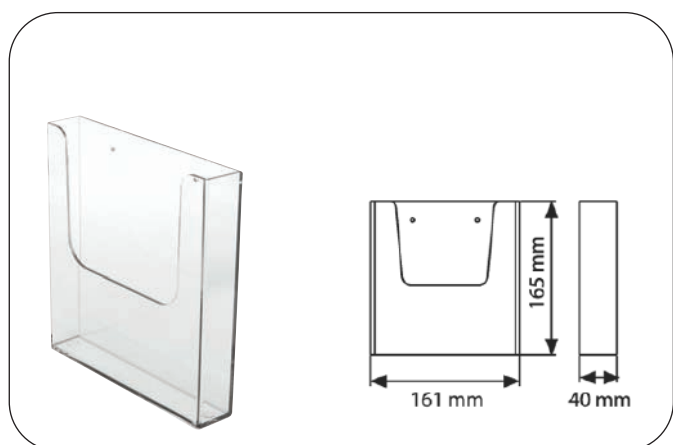

Codice art.	Descrizione	L.P.
MTW160	Portabrochure da parete 1 f.to A5 cm. 15x21	4,00

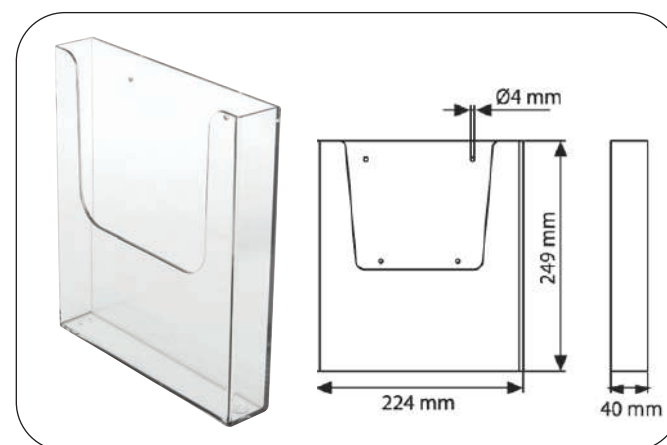

Codice art.	Descrizione	L.P.
MTW230	Portabrochure da parete 1 f.to A4 cm. 21x29,7	7,00



Cod. art.	Descrizione	L.P.
TYVBC56	Portabiglietti da visita ad un scompartimento verticale. Dim. Box mm.56x18	3

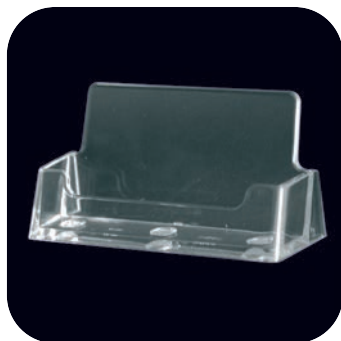

Cod. art.	Descrizione	L.P.
TYBC93	Portabiglietti da visita ad un scompartimento orizzontale. Dim. Box mm.93x18	3

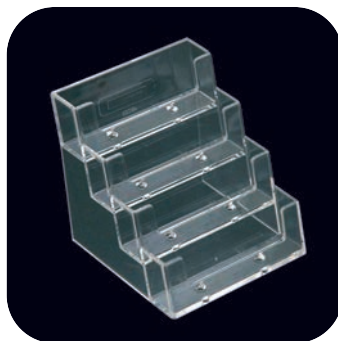

Cod. art.	Descrizione	L.P.
TY4BC93	Portabiglietti da visita a 4 scompartimenti sovrapposti orizzontali. Dim. Box mm.(93x18) x 4	10



Cod. art.	Descrizione	L.P.
TY8BC93	Portabiglietti da visita a 8 scompartimenti orizzontali sovrapposti, disposti su due file. Dim. Box mm.(93x18) x 8	16



Cod. art.	Descrizione	L.P.
TYC110	Portabrochure da banco ad un scompartimento verticale contiene un formato 1/3 A4 (10x21 cm.) Formato Box mm.110x32	5

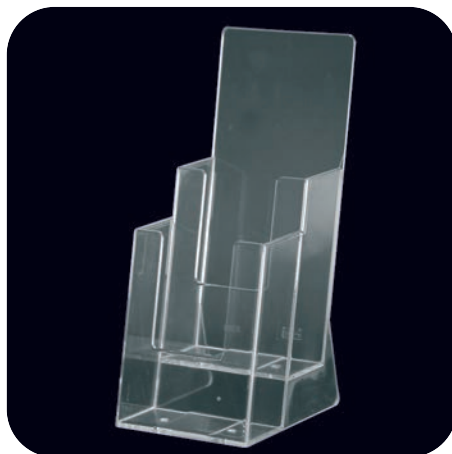

Cod. art.	Descrizione	L.P.
TY2C110	Portabrochure da banco a due scomp. verticali sovrapposti contiene 2 formati 1/3 di A4 (10x21) Formato Box mm.110x45 x 2 box	14



Cod. art.	Descrizione	L.P.
TY2C112	Portabrochure da banco a due scompartimenti vert. affiancati contiene due formati 1/3 A4 (10x21) Formato Box mm.112x30 x 2 box	16

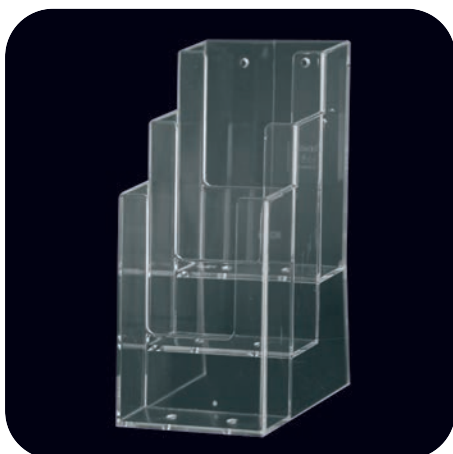

Cod. art.	Descrizione	L.P.
TY3C104	Portabrochure da banco a tre scompartimenti vert. sovrapposti contiene tre formati 1/3 A4 (10x21) Formato Box mm.104x32 x 3 box	19



Cod. art.	Descrizione	L.P.
TY3C110H	Portabrochure da banco a tre scompartimenti vert. affiancati contiene tre formati 1/3 A4 (10x21) Formato Box mm.110x32 x 3 box	17

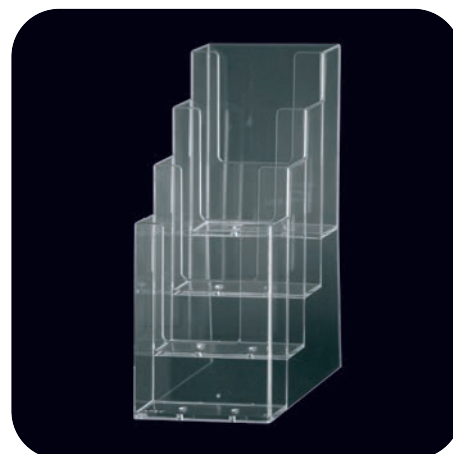

Cod. art.	Descrizione	L.P.
TY4C110	Portabrochure da banco a quattro scompartimenti vert. sovrapposti contiene quattro formati 1/3 A4 (10x21) Formato Box mm.110x32 x 4	20



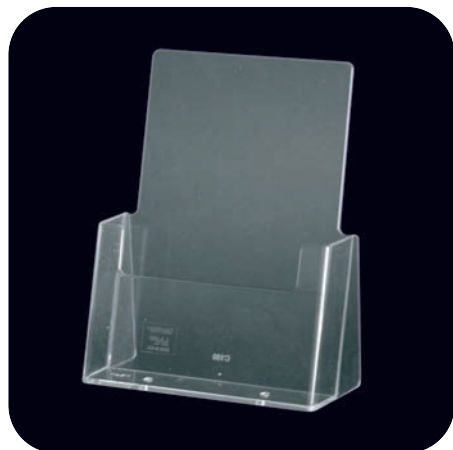

Cod. art.	Descrizione	L.P.
TYC160	Portabrochure da banco ad uno scompartimento verticale contiene un formato A5 (15x21) Formato Box mm.160x32	8



Cod. art.	Descrizione	L.P.
TYCLA5	Portabrochure da banco a uno scompartimento orizzontale contiene un formato A5 (21x15) Formato Box mm. 210x32	12

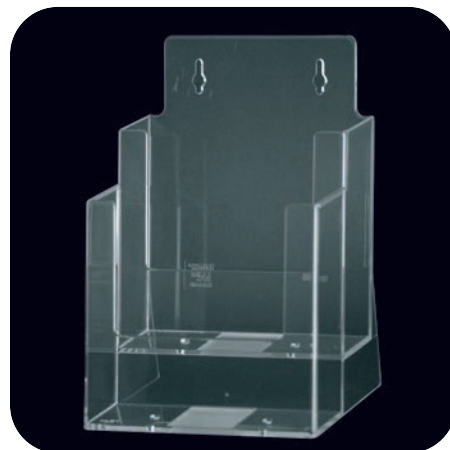

Cod. art.	Descrizione	L.P.
TY2C160	Portabrochure da banco a compart. verticali sovrapposti contiene due formati A5 (15x21) Formato Box mm. 160x32 x 2	17

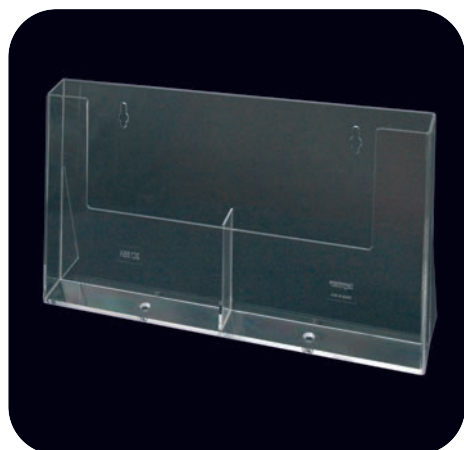

Cod. art.	Descrizione	L.P.
TY2C155H	Portabrochure da banco a scompartimenti vert. affiancati contiene due formati A5 (15x21) Formato Box mm. 160x32 x 2	16



Cod. art.	Descrizione	L.P.
TY3C160	Portabrochure da banco a scompartimenti vert. sovrapposti contiene 3 formati A5 (15x21) Formato Box mm.160x32 x 3	22



Cod. art.	Descrizione	L.P.
TY4C160	Portabrochure da banco scompartimenti vert. sovrapposti contiene quattro formati A5 (15x21) Formato Box mm.160x32 x 4	23



Cod. art.	Descrizione	L.P.
TYC230	Portabrochure da banco ad uno scompartimento verticale contiene un formato A4 (21x30) Formato Box mm.230x32	14

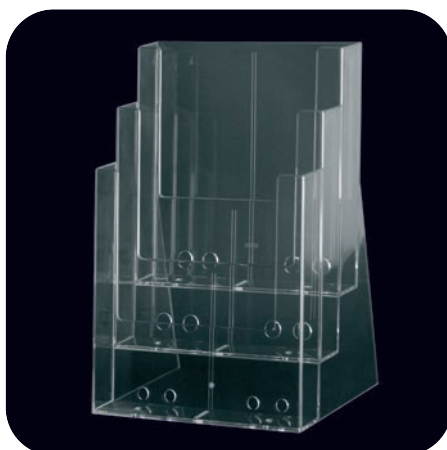

Cod. art.	Descrizione	L.P.
TY3C230	Portabrochure da banco scompartimenti verticali sovrapposti contiene tre formati A4 (21x30) Formato Box mm.230x32 x 3	50

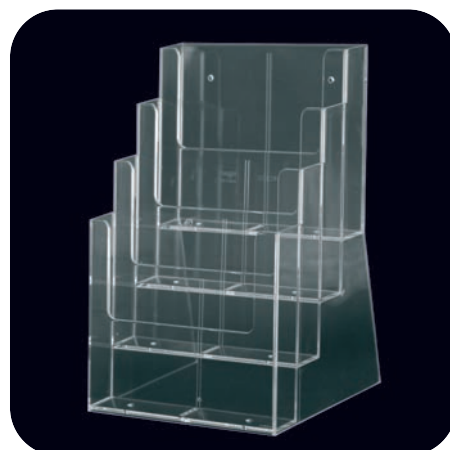

Cod. art.	Descrizione	L.P.
TY4C230	Portabrochure da banco a scompartimenti vert. sovrapposti contiene quattro formati A4 (21x30) Formato Box mm.230x32 x 4	50



Cod. art.	Descrizione	L.P.
TYC330	Portabrochure da banco ad un scompartimento orizzontale contiene un formato A4 (30x21) Formato Box mm.330x32	17



Cod. art.	Descrizione	L.P.
TY4C330	Portabrochure da banco scompartimenti orizz. sovrapposti contiene quattro formati A4 (30x21) Formato Box mm.330x32 x 4	70

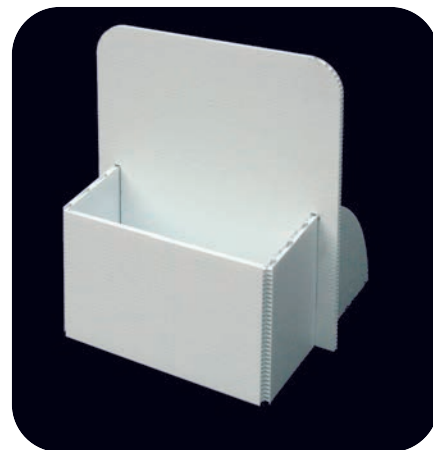

Cod. art.	Descrizione	L.P.
TPOC110	Portabrochure in polionda Contiene un formato 1/3 di A4 (10x21 cm.) Formato Box mm.110x70	4
TPOC160	Portabrochure in polionda Contiene un formato A5 (15x21 cm.) Formato Box mm.160x70	5
TPOC230	Portabrochure in polionda Contiene un formato A4 (21x30 cm.) Formato Box mm.220x70	6

## TASCA VISION

Porta-brochure da parete con supporto in alluminio anodizzato silver, e tasche in Perspex trasparente f.to A4.

Wall brochure holders with aluminum anodized silver, and pockets in transparent Perspex f.to A4.

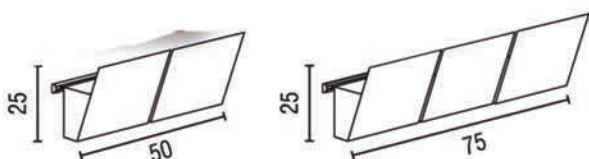
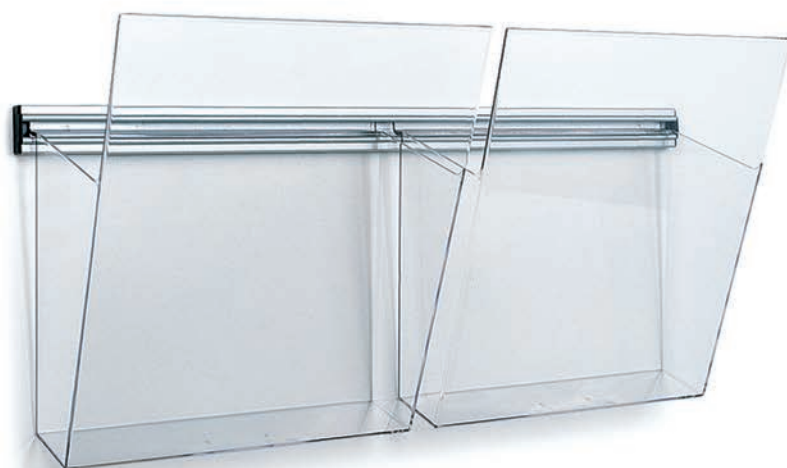

### SCHEDA TECNICA

Cod. articolo	Descrizione	Dimensioni cm.	Profondità cm.	L.P.
TYVIS2A4	Porta brochure Vision a 2 tasche f.to A4	50x25	14	52
TYVIS3A4	Porta brochure Vision a 3 tasche f.to A4	75x25	14	72



Cod. art.	Descrizione	L.P.
TYW110	Portabrochure da parete ad uno scompartimento vert. contiene un formato 1/3 A4 (10x21) Formato Box mm.110x32	7



Cod. art.	Descrizione	L.P.
TY3W110H	Portabrochure da parete scompartimenti vert. affiancati contiene tre formati 1/3 A4 (10x21) Formato Box mm.110x32 x 3	18

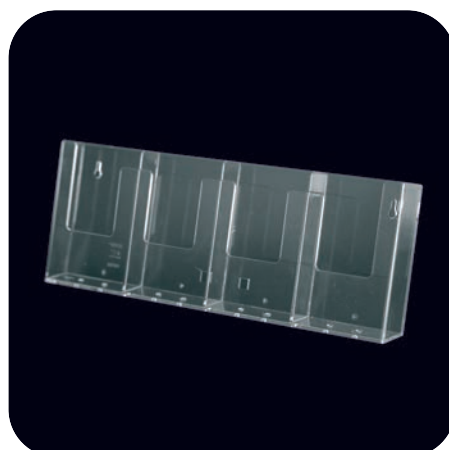

Cod. art.	Descrizione	L.P.
TY4W104	Portabrochure da parete scompartimenti vert. affiancati contiene quattro formati 1/3 A4 (10x21) Formato Box mm.104x32 x 4	22



Cod. art.	Descrizione	L.P.
TYW160	Portabrochure da parete ad uno scompartimento verticale contiene un formato A5 (15x21) Formato Box mm.160x32	11



Cod. art.	Descrizione	L.P.
TY2W155H	Portabrochure da parete a scompartimenti vert. affiancati contiene due formati A5 (15x21) Formato Box mm.160x32 x 2	18

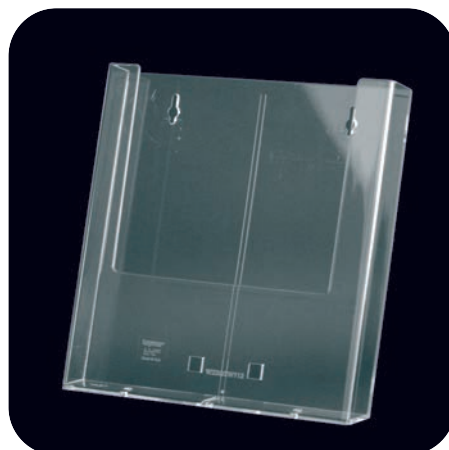

Cod. art.	Descrizione	L.P.
TYW230	Portabrochure da parete ad uno scompartimento vert. contiene un formato A4 (21x30) Formato Box mm.230x32	16



Cod. art.	Descrizione	L.P.
TY3W230	Portabrochure da parete a scompartimenti vert. sovrapposti contiene tre formati A4 (21x30) Formato Box mm.230x32x3	67

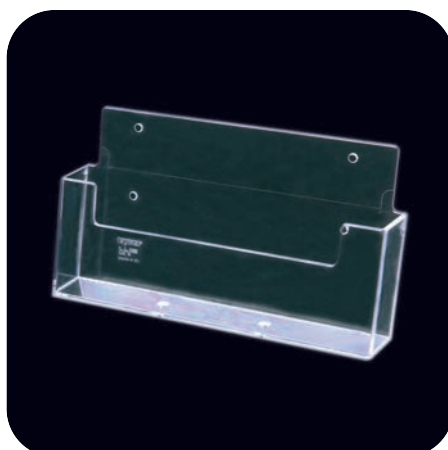

Cod. art.	Descrizione	L.P.
TYWLA5	Portabrochure da parete ad uno scompartimento orizz. contiene un formato A5 (21x15) Formato Box mm.230x32	14



Cod. art.	Descrizione	L.P.
TYW330	Portabrochure da parete ad uno scompartimento orizz. contiene un formato A4 (30x21) Formato Box mm.330x32	18

# WALL UNIT

**new  
PRODUCT**

Portabrochure da parete, realizzata in materiale plastico stampato, composto da tasche nei formati A4, A5 ed 1/3 di A4. Disponibile in tre colori, bianco, nero e grigio.

*Plastic wall structure for brochures-holder, made of pockets in A4, A5 and 1/3 A4 sizes. Available in three colours, white, black and grey.*



3X A4 GRIGIO



4 X A5 BIANCO



4 X 1/3 A4 NERO



ESPOSITORI

130

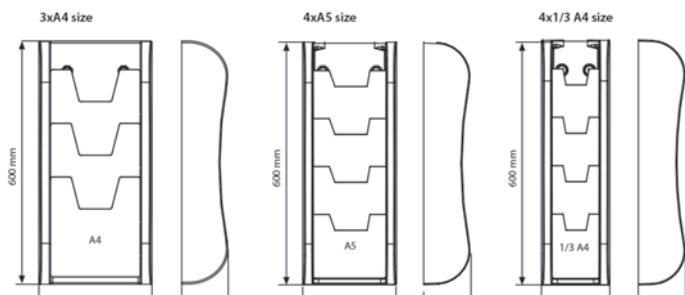

## SCHEDA TECNICA

Codice art.	Colore	Formato tasche	L.P.
MTWAUN3A4B	Bianco	3 x A4	48
MTWAUN3A4N	Nero	3 x A4	48
MTWAUN3A4G	grigio	3 x A4	48
MTWAUN4A5B	Bianco	4 x A5	44
MTWAUN4A5N	Nero	4 x A5	44
MTWAUN4A5G	grigio	4 x A5	44
MTWAUN413B	Bianco	1/3 di A4	36
MTWAUN413N	Nero	1/3 di A4	36
MTWAUN413G	grigio	1/3 di A4	36

# PLEX BOX

Serie di contenitori realizzati in Perspex trasparente, adatti a contenere dei formati A4. Grazie all'alta qualità del Perspex, sono durevoli e resistenti. Hanno una grande capacità di carico, e possono essere disposti a parete o a bandiera.

*Series of boxes made by clear plexiglas material, suitable for A4 format. Thanks to the plexiglas high quality, it is durable and resistant during the time. It's able to hold out a big quantity load. Can be arranged on the wall or positionable flag on the wall.*

**new  
PRODUCT**

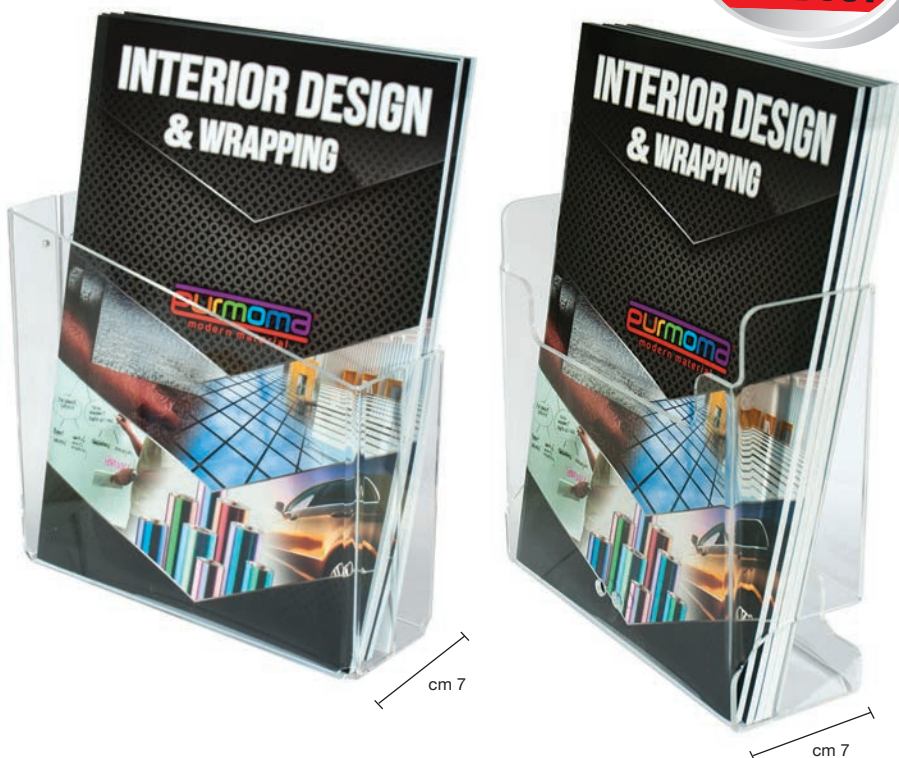

## SCHEDA TECNICA

Codice art.	Formato	L.P.
EUPLBOXPA4	A4 parete	50
EUPLBOXPA5	A5 parete	40
EUPLBOXBA4	A4 bandiera	50
EUPLBOXBA5	A5 bandiera	40

# METAL DEPLIANT

Porta-depliant autoportante in metallo, offre alloggio per 5 scomparti formato A4. La sacca per il trasporto è inclusa nella confezione.

*Freestanding brochure holder in metal, offers accommodation for 5 compartment A4. The carrying bag is included in the package.*



## SCHEDE TECNICA

Codice art.	Descrizione	Sacca cm.	Altezza cm.	Peso Kg.	L.P.
DWMEDE5A4	Portadepliant a 5 scomparti A4	32x28x37	143,5	7,5	140

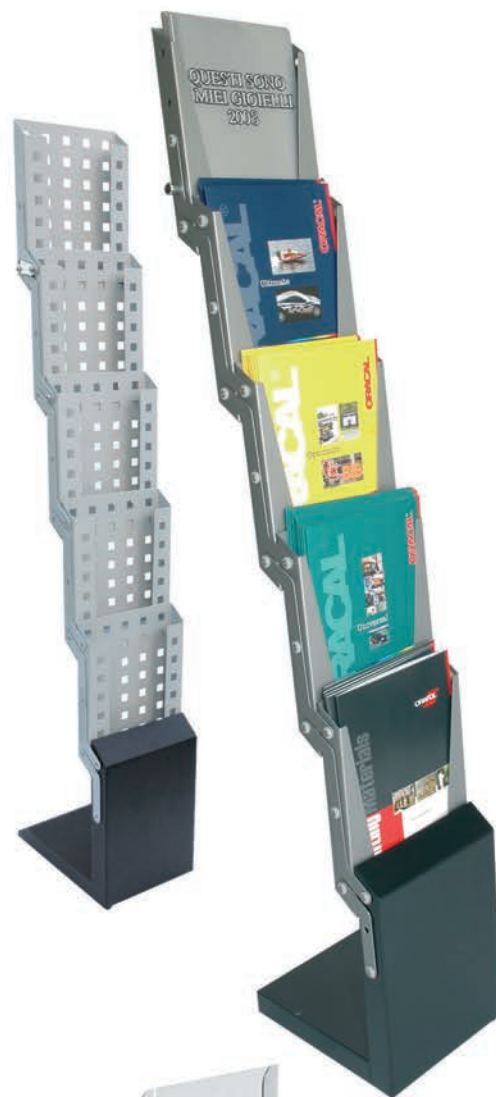

# STEEL DEPLIANT

Porta-depliant autoportante in acciaio cromato, con quattro tasche f.to A4 in materiale plastico trasparente. La sacca per il trasporto è compresa nella confezione.

*Freestanding brochure holder in chromed steel, with four pockets f.to A4 transparent plastic. The carrying bag is included in the package.*



## SCHEDE TECNICA

Codice art.	Descrizione	Sacca cm.	Altezza cm.	Peso Kg.	L.P.
DWSTDE4A4	Portadepliant a 4 scomparti A4	30x30x47	156	7	185



# US PLEXBOX

**new  
PRODUCT**

Struttura autoportante in alluminio silver con base in PVC-HD cm. 36x36 e tasche porta-brochure in Perspex trasparente ad ALTA CAPIENZA CON UNA PROFONDITÀ DI CM 7; disponibili in due varianti: Frontale e a Bandiera.

*Self supporting aluminum silver structure with PVC-HD base cm 36x36 and transparent Perspex brochure holder with HIGH CAPACITY CM 7 DEPTH; pockets are available in two variants: front and lateral.*



Tasca Frontale

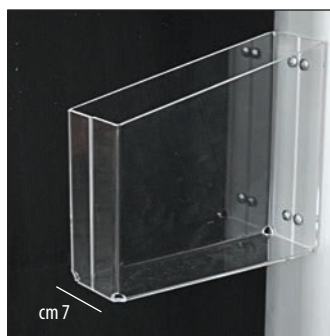

Tasca a Bandiera

## SCHEDA TECNICA PLEX BOX ALTA CAPACITÀ

Codice art.	Descrizione	Altezza cm.	F.to tasche	Base cm.	L.P.
EUUSPLEBOF	Tasche frontali	170	A4	36x36	264
EUUSPLEBOB	Tasche a bandiera	170	A4	36x36	414

**ALTRE MISURE SU RICHIESTA**

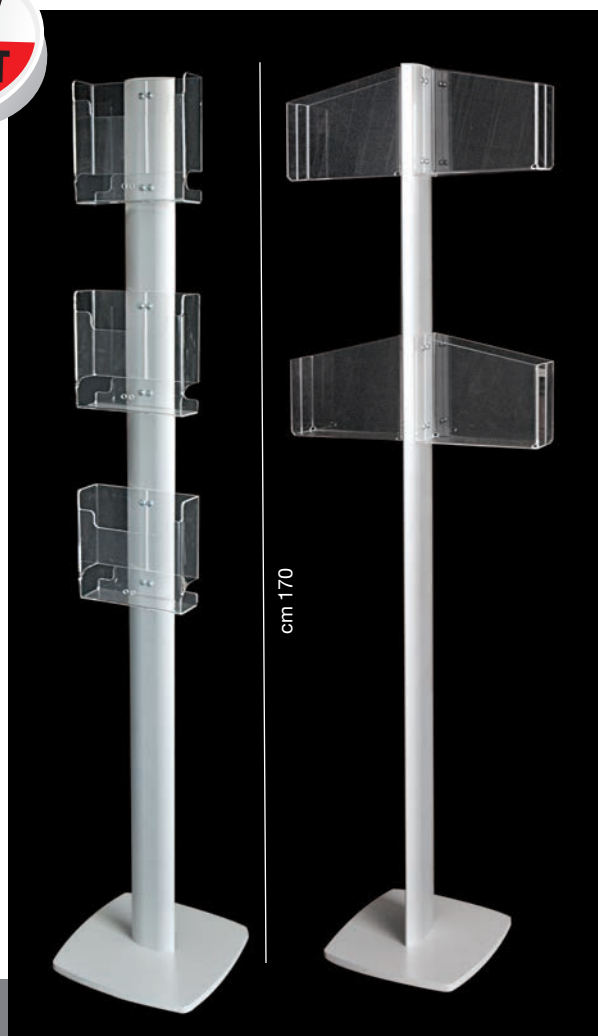

# ZICK ZACK

Porta-brochure autoportante in metallo, con base in materiale plastico antiurto e tasche in plastica trasparenti formato A4. Si trasporta facilmente grazie alla sacca inclusa nel prezzo.

*Door - brochure -standing metal base with impact-resistant plastic and transparent plastic pockets A4. Easy to carry thanks to the bag included.*

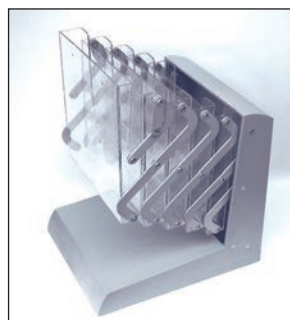

## SCHEDA TECNICA

Codice art.	Descrizione	Sacca cm.	Altezza cm.	L.P.
MTZZ5A4	Portadepliant richiudibile a 5 tasche f.to A4	34x26x43	134	200

# VELAPLEX

Tasca porta messaggi realizzata in Perspex trasparente, disponibile sia per fissaggio a parete con biadesivo, sia per fissaggio a sospensione con pinze e tiranti. È disponibile sia verticale che orizzontale.  
*Pocket messages made of transparent Perspex, available for wall fixing with double-sided tape, both for suspended with clamps and rods. It is available in both vertical and horizontal.*

## SCHEDA TECNICA VELA SEMPLICE DA PARETE

Codice art.	Formato tasca	L.P.
EUVELSEA4	A4 verticale	10
EUVELSEA3	A3 verticale	20
EUVELSE57	B2 50x70 verticale	58
EUVELSE710	B1 70x100 verticale	85
EUVELSEA2	A2 42x59,4 verticale	50
EUVELSEA1	A1 59,4x84,1 verticale	90
EUVELSEA0	A0 84,1x118,9 verticale	225
EUVELSEA4HO	A4 orizzontale	11
EUVELSEA3HO	A3 orizzontale	20
EUVELSE57HO	B2 50x70 orizzontale	53
EUVELSE710HO	B1 70x100 orizzontale	160
EUVELSEA2HO	A2 59,4x42 orizzontale	55
EUVELSEA1HO	A1 84,1x59,4 orizzontale	112
EUVELSEA0HO	A0 118,9x84,1 orizzontale	225

## SCHEDA TECNICA VELA SAGOMATA A SOSPENSIONE

Codice art.	Formato tasca	L.P.
EUVESAA4	A4 verticale	14
EUVESAA3	A3 verticale	28
EUVESA57	B2 50x70 verticale	80
EUVESAA710	B1 70x100 verticale	116
EUVESAA2	A2 42x59,4 verticale	60
EUVESAA1	A1 59,4x84,1 verticale	100
EUVESAA0	A0 84,1x118,9 verticale	225
EUVESAA4HO	A4 orizzontale	14
EUVESAA3HO	A3 orizzontale	28
EUVESA57HO	B2 50x70 orizzontale	72
EUVESA710HO	B1 70x100 orizzontale	225
EUVESAA2HO	A2 59,4x42 orizzontale	60
EUVESAA1HO	A1 84,1x59,4 orizzontale	115
EUVESAA0HO	A0 118,9x84,1 orizzontale	225

## SCHEDA TECNICA VELA SEMPLICE CON TESTATA E FORI

Codice art.	Formato tasca	L.P.
EUVELSEA4TF	A4 verticale	12
EUVELSEA3TF	A3 verticale	22
EUVELSE57TF	B2 50x70 verticale	60
EUVELSE710TF	B1 70x100 verticale	90
EUVELSEA4HOTF	A4 orizzontale	13
EUVELSEA3HOTF	A3 orizzontale	22
EUVELSE57HOTF	B2 50x70 orizzontale	60



VELA SEMPLICE

VELA SAGOMATA



VELA SEMPLICE CON TESTATA E FORI

# CLEAR FRAME

Tasca porta-messaggi in Perspex trasparente per vetrine o porte a vetro, da fissare mediante le 4 ventose incluse nella confezione.

*Door - posts Perspex transparent pocket windows or glass doors, to be determined by the four suction cups included in the package.*

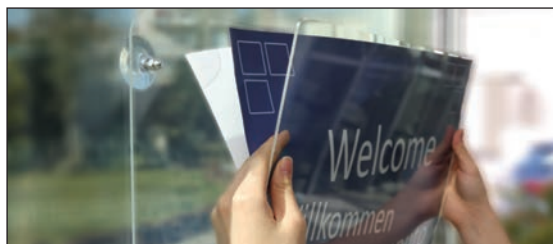

## SCHEDA TECNICA

Codice art.	Grafica cm.	Pezzi confez.	L.P.
EUCLEFRAA4V	A4 verticale 21x29,7	10	220
EUCLEFRAA4H	A4 orizzontale 21x29,7	10	220
EUCLEFRAA3V	A3 verticale 29,7x42	10	360



ALTRE MISURE SU RICHIESTA

# SERIE PODIO



Kit di alzate, disponibili in tre misure a scalare, realizzate in Perspex di spessore 5 mm. o 10 mm. sono disponibili in tre colori, trasparente, nero o fumè grigio. Molto in uso per evidenziare la merce esposta, indispensabili per l'allestimento di vetrine.

*Plexiglas 5 or 10 mm thickness. Structure available in three steps to climb. Colors available, clear, black and smoked grey. It's especially used to emphasize any items or to set up the shop window.*

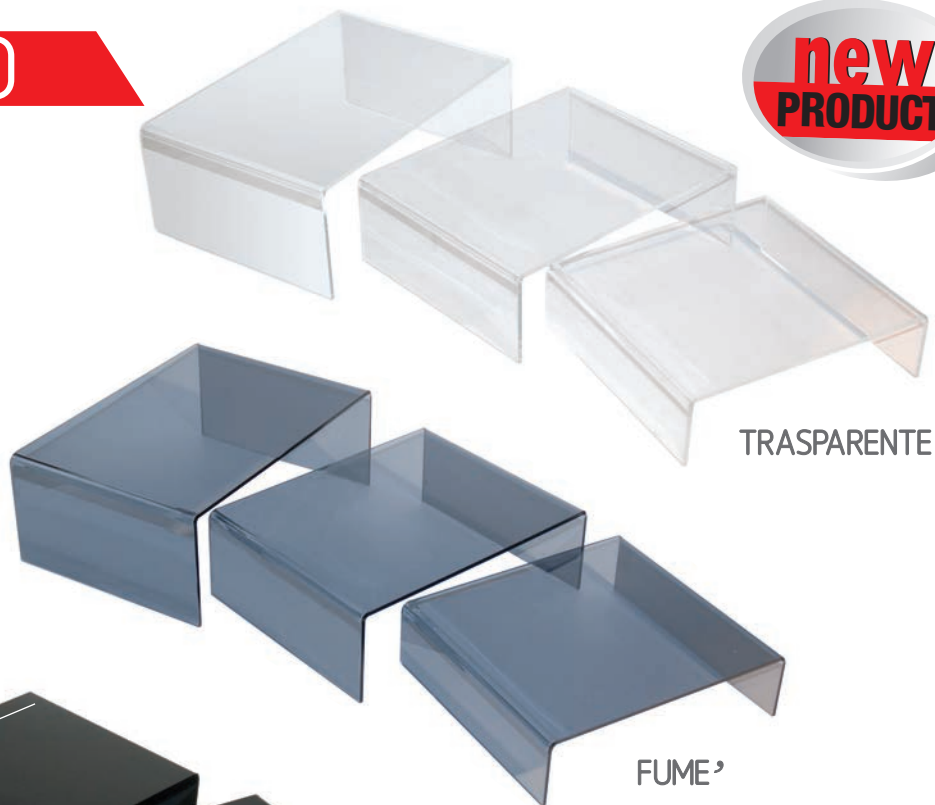

TRASPARENTE

FUMÈ

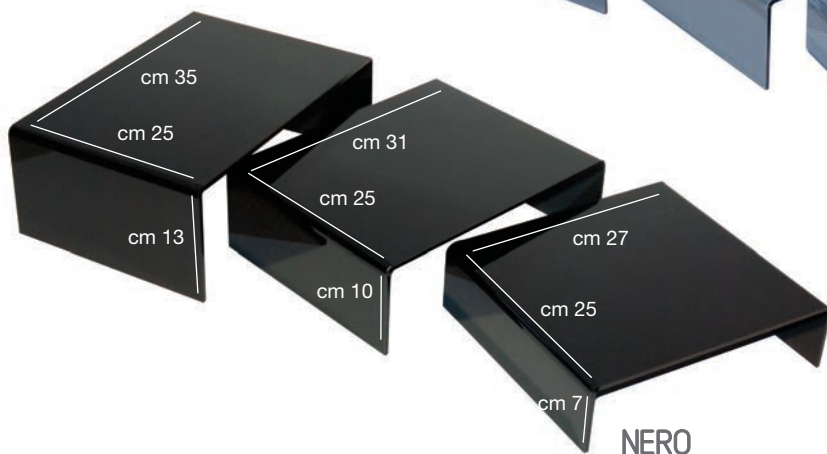

NERO

## SCHEDA TECNICA

Codice art.	Descrizione	Colore	L.P.
EUPODIO5TR	Kit Podio 3 pz. spessore 5 mm.	Trasparente	120
EUPODIO5NE	Kit Podio 3 pz. spessore 5 mm.	Nero	138
EUPODIO5FU	Kit Podio 3 pz. spessore 5 mm.	Fumè	138
EUPODIO10TR	Kit Podio 3 pz. spessore 10 mm.	Trasparente	200
EUPODIO10NE	Kit Podio 3 pz. spessore 10 mm.	Nero	230
EUPODIO10FU	Kit Podio 3 pz. spessore 10 mm.	Fumè	230

ALTRE MISURE SU RICHIESTA

# CESTO GLOBE

Espositore con struttura portante in pvc espanso nero ad incastro, e cesto in materiale plastico trasparente. Disponibile in tre diverse altezze da cm. 75, cm. 100 e cm. 125 e in un'unica larghezza di cm. 50.

*Exhibitor with structure in black expanded PVC interlocking, and basket in clear plastic. Available in three different heights cm. 75 cm. 100 and cm. 125 and on one cm wide. 50*

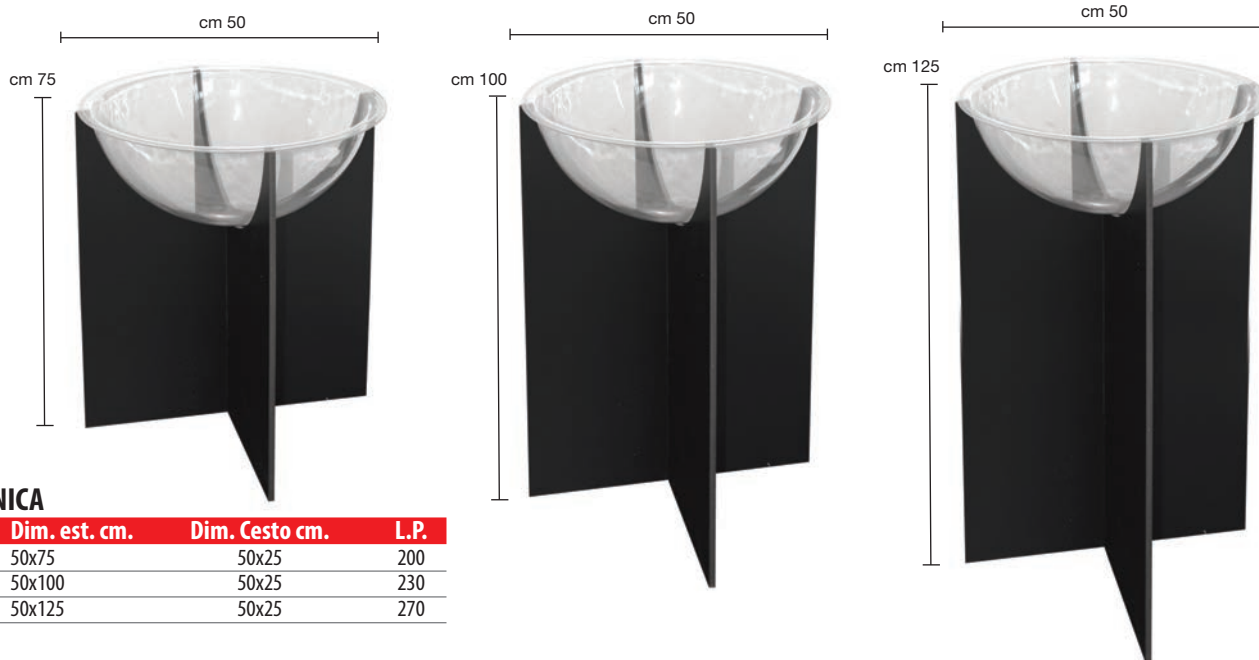

## SCHEDA TECNICA

Codice art.	Dim. est. cm.	Dim. Cesto cm.	L.P.
EUGL05075	50x75	50x25	200
EUGL050100	50x100	50x25	230
EUGL050125	50x125	50x25	270



# DUAL PLATE

Coppia di targhe in Perspex trasparente, fissate tramite magneti applicati all'interno dello spessore, dove trova alloggio la grafica. Quest'ultima può essere facilmente sostituita. È possibile averle anche con fondo in Perspex nero lucido. Disponibile in altri formati e sagome per determinati quantitativi.

*Pair of transparent Perspex plaque, fixed with magnets applied within the thickness, where accommodation is the graphics which can be easily replaced. It is also available with Perspex black gloss back, and in other sizes and shapes.*



MODELLO A TRASPARENTE



MODELLO B TRASPARENTE

## SCHEDA TECNICA MOD. A TRASPARENTE 6+6

Codice art.	Dim. cm.	Spess. mm.	Peso Kg	L.P.
EUDUPLA61010A	10x10	6+6	0.2	18
EUDUPLA61015A	10x15	6+6	0.2	22
EUDUPLA61318A	13x18	6+6	0.2	31
EUDUPLA61521A	15x21	6+6	0.2	35
EUDUPLA62130A	21x30	6+6	0.2	52

## SCHEDA TECNICA MOD. B TRASPARENTE 6+6

Codice art.	Dim. cm.	Spess. mm.	Peso Kg	L.P.
EUDUPLA61010B	10x10	6+6	0.2	18
EUDUPLA61015B	10x15	6+6	0.2	22
EUDUPLA61318B	13x18	6+6	0.3	31
EUDUPLA61521B	15x21	6+6	0.2	35
EUDUPLA62130B	21x30	6+6	0.2	52

## SCHEDA TECNICA MOD. A TRASPARENTE 8+8

Codice art.	Dim. cm.	Spess. mm.	Peso Kg	L.P.
EUDUPLA81010A	10x10	8+8	0.2	20
EUDUPLA81015A	10x15	8+8	0.3	25
EUDUPLA81318A	13x18	8+8	0.3	35
EUDUPLA81521A	15x21	8+8	0.6	40
EUDUPLA82130A	21x30	8+8	1.2	60

## SCHEDA TECNICA MOD. B TRASPARENTE 8+8

Codice art.	Dim. cm.	Spess. mm.	Peso Kg	L.P.
EUDUPLA81010B	10x10	8+8	0.2	20
EUDUPLA81015B	10x15	8+8	0.3	25
EUDUPLA81318B	13x18	8+8	0.3	35
EUDUPLA81521B	15x21	8+8	0.6	40
EUDUPLA82130B	21x30	8+8	1.2	60



MODELLO A FONDO NERO

## SCHEDA TECNICA MOD. A TRASPARENTE 15+15

Codice art.	Dim. cm.	Spess. mm.	Peso Kg	L.P.
EUDUPLA151521A	15x21	15+15	1.2	60
EUDUPLA152130A	21x30	15+15	2.4	100

## SCHEDA TECNICA MOD. B TRASPARENTE 15+15

Codice art.	Dim. cm.	Spess. mm.	Peso Kg	L.P.
EUDUPLA151521B	15x21	15+15	1.2	60
EUDUPLA152130B	21x30	15+15	2.4	100



MODELLO B FONDO NERO

## SCHEDA TECNICA MOD. A FONDO NERO 10+8

Codice art.	Dim. cm.	Spess. mm.	Peso Kg	L.P.
EUDUPL1010AN	10x10	10+8	0.2	20
EUDUPL1015AN	10x15	10+8	0.3	25
EUDUPL1521AN	15x21	10+8	0.6	40
EUDUPL2130AN	21x30	10+8	1.2	60

## SCHEDA TECNICA MOD. B FONDO NERO 10+8

Codice art.	Dim. cm.	Spess. mm.	Peso Kg	L.P.
EUDUPL1010BN	10x10	10+8	0.2	20
EUDUPL1015BN	10x15	10+8	0.3	25
EUDUPL1521BN	15x21	10+8	0.6	40
EUDUPL2130BN	21x30	10+8	1.2	60

ALTRE MISURE SU RICHIESTA

# TOURIST SIGNAL

Palette realizzate in PVC espanso, spessore mm. 8, disponibili in diverse forme e dimensioni. Consentono di ottenere una grande visibilità, ed hanno una comoda ed ergonomica impugnatura.

*Signaling disks made of PVC foam, thickness mm. 8, available in different shapes and sizes. They achieve a high visibility, and they have a comfortable and ergonomic grip.*



## SCHEMA TECNICA

Codice art.	Descrizione	Conf.	Dim. grafica cm.	L.P.
EUTSCIRC20	Paletta circolare in pvc diam. cm.20 spess. 8 mm.	10 pz.	Diam. cm. 21	72
EUTSCIRC30	Paletta circolare in pvc diam. cm.30 spess. 8 mm.	10 pz.	Diam. cm. 29,5	120
EUTSLL2030	Paletta ellittica in pvc dim. cm. 20x30 spess. 8mm.	10 pz.	cm. 20x29,5	96
EUTSLL3040	Paletta ellittica in pvc dim. cm. 30x40 spess. 8mm	10 pz.	cm. 30x42	144
EUTSRET2030	Paletta rettangolare in pvc dim. cm. 20x30 spess. 8 mm.	10 pz.	cm. 21x29,5	120
EUTSRET3040	Paletta rettangolare in pvc dim. cm. 30x40 spess. 8 mm.	10 pz.	cm. 30x42	150

ALTRE MISURE SU RICHIESTA

# AUTOMOTIVE

Serie di prodotti dedicata al settore della vendita di automobili.

## MIRROR GLASS

Tasca formato A4 realizzata in policarbonato trasparente tagliato a laser e resistente alle alte temperature, disponibile sia verticale che orizzontale; tramite un apposito gancio, si fissa allo specchietto retrovisore.

## WINDOW GLASS

Stessa fattura e caratteristiche del MIRROR GLASS, ma con gancio differente ed apposito per il fissaggio sui vetri laterali della automobili.

*Series of products dedicated to the business of selling cars.*

## MIRROR GLASS

*Pocket A4 made of polycarbonate laser cut and heat resistant, available in both vertical and horizontal; through a special hook, fixed to the rearview mirror.*

## WINDOW GLASS

*The same bill and features MIRROR GLASS, but with different and special hook for fastening on the side windows of cars.*



## SCHEMA TECNICA MIRROR GLASS

Codice art.	Descrizione	Dim. grafica cm.	L.P.
EUAUTGANA4HO	Tasca portamessaggi f.to A4 orizzontale	30x21	14
EUAUTGANA4	Tasca portamessaggi f.to A4 verticale	21x30	14

## SCHEMA TECNICA WINDOWS GLASS

Codice art.	Descrizione	Dim. grafica cm.	L.P.
EUAUTVETA4HO	Tasca portamessaggi f.to A4 orizzontale	30x21	15
EUAUTVETA4	Tasca portamessaggi f.to A4 verticale	21x30	15

ALTRE MISURE SU RICHIESTA

# FLEXIBLE

Struttura in alluminio anodizzato colore silver, con cornice klik klak regolabile con un angolo di 90°, sia verticale che orizzontale.

Structure Anodized aluminum silver color, framed Klik Klak adjustable at an angle of 90°, both vertically and horizontally.



## SCHEMA TECNICA

Codice art.	Cornice cm.	Grafica cm.	Imballo cm.	Peso Kg	L.P.
MTFLXA4	A4 21x29,7	21x29,7	28,5x103x10,2	5,2	138
MTFLXA3	A3 29,7x42	29,7x42	36,5x101x10,2	6,8	188

# FLEXIBLE LED

Struttura in alluminio anodizzato colore silver, con cornice klik klak illuminata a Led con trasformatore a bassa tensione da 12V. Regolabile con un angolo di 90°, sia in verticale che in orizzontale.

Structure anodized aluminum frame color silver, framed Klik Klak lit LEDs with low voltage transformer 12V. Adjustable with an angle of 90°, both vertically and horizontally.



**LED TECHNOLOGY**



## SCHEMA TECNICA

Codice art.	Cornice cm.	Grafica cm.	L.P.
MTFLXDA4	A4 21x29,7	21x29,7	294
MTFLXDA3	A3 29,7x42	29,7x42	384

# ZETA PERSPEX

Espositore autoportante realizzato in Perspex dove è possibile abbinare accessori come cornici klik klak, portabrochure, targhe, ecc. Disponibile in Perspex trasparente, fumè, nero lucido, nero opaco bisatinato e bisabbiato.

*Perspex freestanding exhibiting, it can be combined with accessories such as frames Klik Klak, portabrochure, plates, etc. Available in Perspex transparent, tinted, black gloss, frosted matt black on both sides and sand blasted on both sides.*

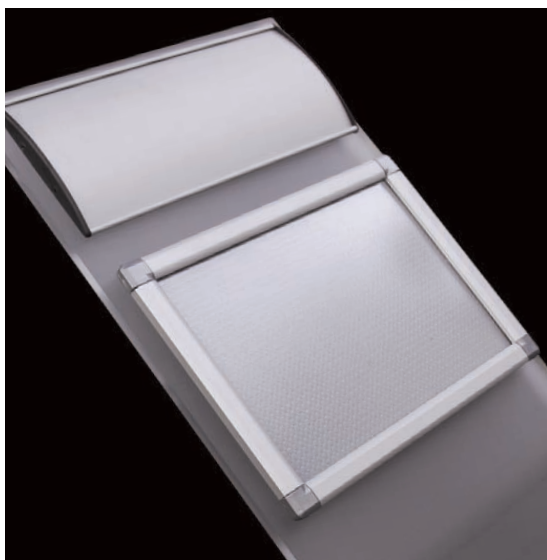
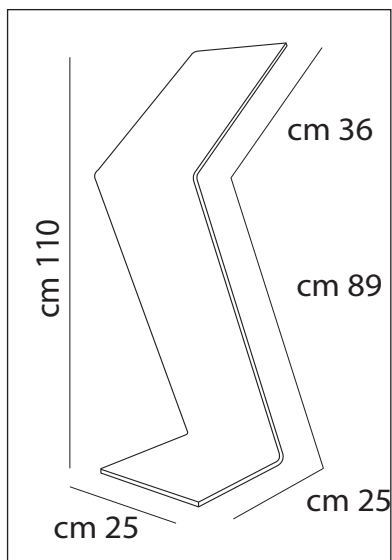

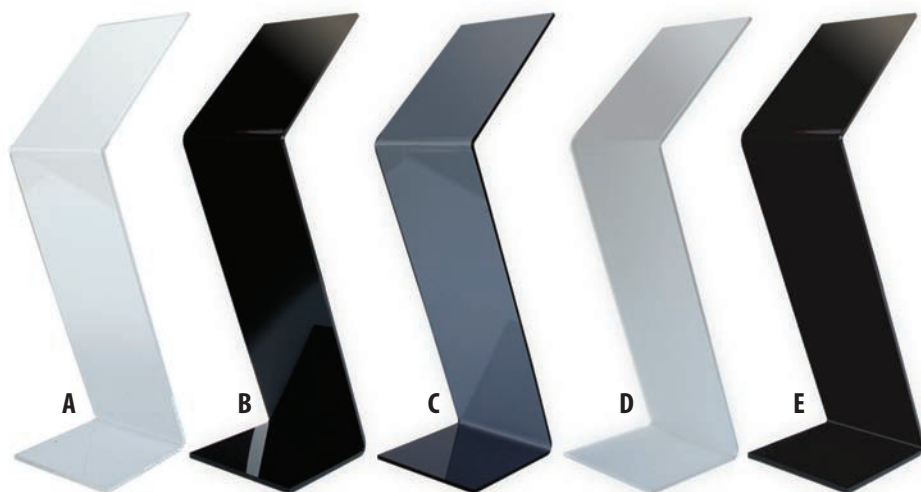

## SCHEMA TECNICA

Codice art.	Descrizione	L.P.
EUZETAPEA	ZetaPerspex A trasparente	120
EUZETAPEB	ZetaPerspex B nero lucido	120
EUZETAPEC	ZetaPerspex C fumè grigio	120
EUZETAPEE	ZetaPerspex D trasparente bisatinato	120
EUZETAPEE	ZetaPerspex E nero opaco bisatinato	120

## ZETA PERSPEX TRASPARENTE



## SCHEMA TECNICA

Codice art.	Descrizione	L.P.
EUZETAPE1	ZetaPerspex + 1 klik-klak A4	130
EUZETAPE2	ZetaPerspex + 2 klik-klak A5	134
EUZETAPE3	ZetaPerspex + 1 p.brochure A4	136
EUZETAPE4	ZetaPerspex + 2 p.brochure 1/3 A4 + targa Delta 10x20	156

## ZETA PERSPEX FUMÈ GRIGIO

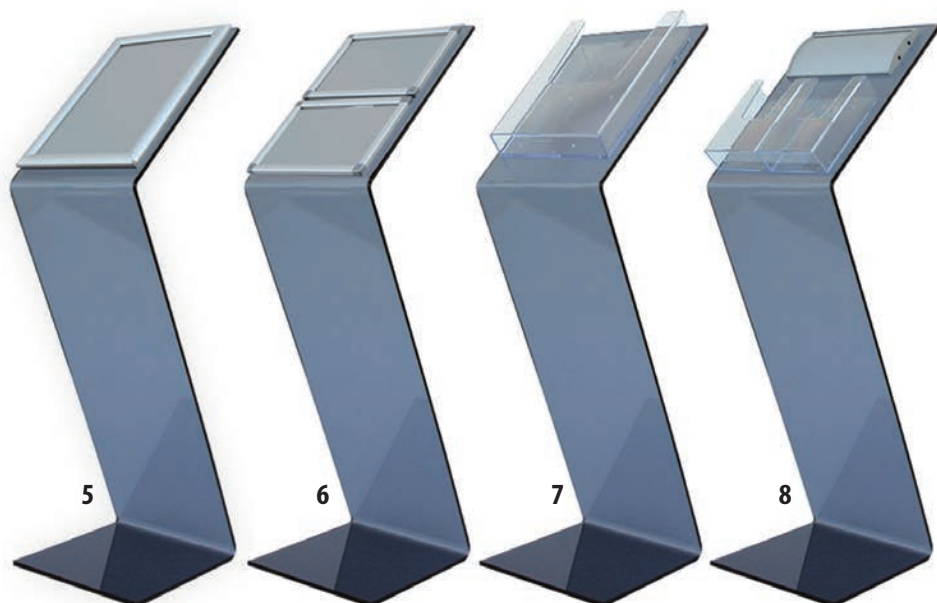

## SCHEMA TECNICA

Codice art.	Descrizione	L.P.
EUZETAPE5	ZetaPerspex + 1 klik-klak A4	130
EUZETAPE6	ZetaPerspex + 2 klik-klak A5	134
EUZETAPE7	ZetaPerspex + 1 p.brochure A4	136
EUZETAPE8	ZetaPerspex + 2 p.brochure 1/3 A4 + targa Delta 10x20	156

## ZETA PERSPEX TRASPARENTE BISATINATO



### SCHEDA TECNICA

Codice art.	Descrizione	L.P.
EUZETAPE9	ZetaPerspex + 1 klik-klak A4	120
EUZETAPE10	ZetaPerspex + 2 klik-klak A5	134
EUZETAPE11	ZetaPerspex + 1 p.brochure A4	136
EUZETAPE12	ZetaPerspex + 2 p.brochure 1/3 A4 + targa Delta 10x20	156

## ZETA PERSPEX NERO LUCIDO

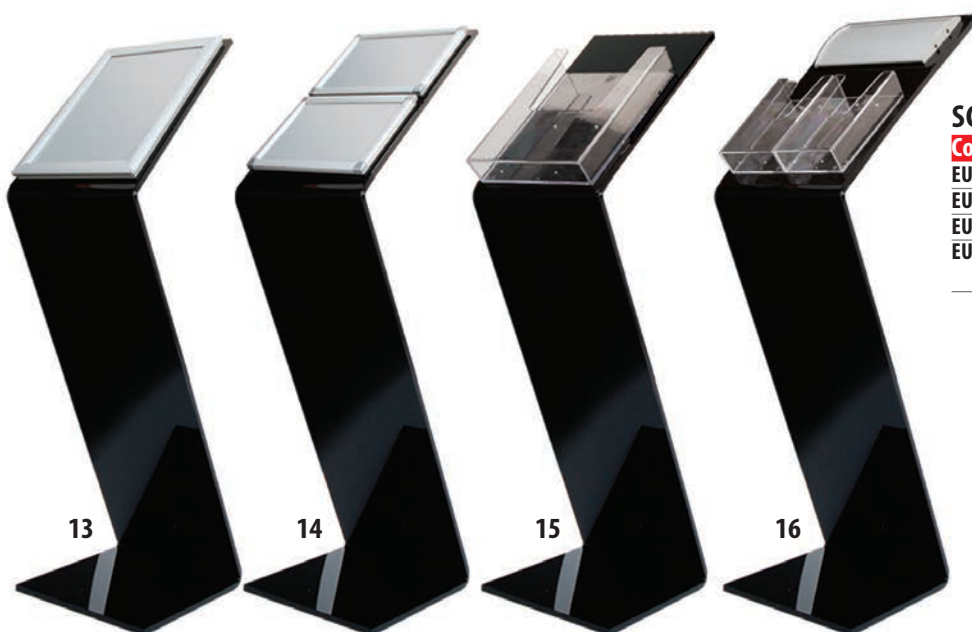

### SCHEDA TECNICA

Codice art.	Descrizione	L.P.
EUZETAPE13	ZetaPerspex + 1 klik-klak A4	130
EUZETAPE14	ZetaPerspex + 2 klik-klak A5	134
EUZETAPE15	ZetaPerspex + 1 p.brochure A4	136
EUZETAPE16	ZetaPerspex + 2 p.brochure 1/3 A4 + targa Delta 10x20	156

## ZETA PERSPEX NERO OPACO BISATINATO

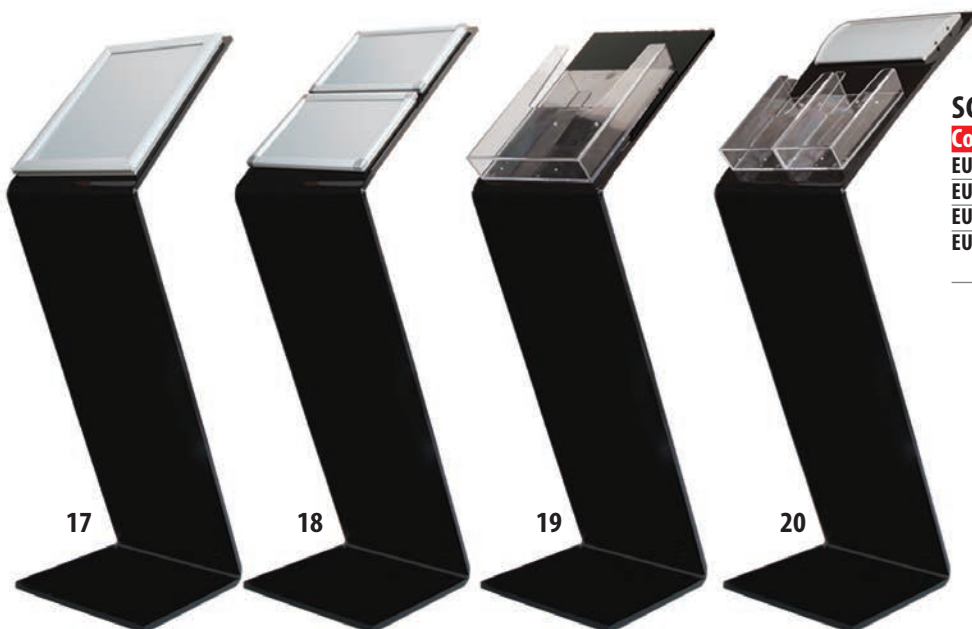

### SCHEDA TECNICA

Codice art.	Descrizione	L.P.
EUZETAPE17	ZetaPerspex + 1 klik-klak A4	130
EUZETAPE18	ZetaPerspex + 2 klik-klak A5	134
EUZETAPE19	ZetaPerspex + 1 p.brochure A4	136
EUZETAPE20	ZetaPerspex + 2 p.brochure 1/3 A4 + targa Delta 10x20	156

# ELLE PERSPEX

Espositore autoportante realizzato in Perspex, disponibile nelle due altezze Standard e Nano; è possibile abbinare accessori come cornici klik klak, portabrochure, targhe, ecc. Disponibile in Perspex trasparente, fumè, nero lucido, nero opaco bisatinato e bisabbiato.

*Perspex freestanding exhibiting, available in two heights Standard and Nano; it can be combined with accessories such as frames Klik Klak, portabrochure, plates, etc. Available in Perspex transparent, tinted, black gloss, frosted matt black on both sides and sand blasted on both sides.*



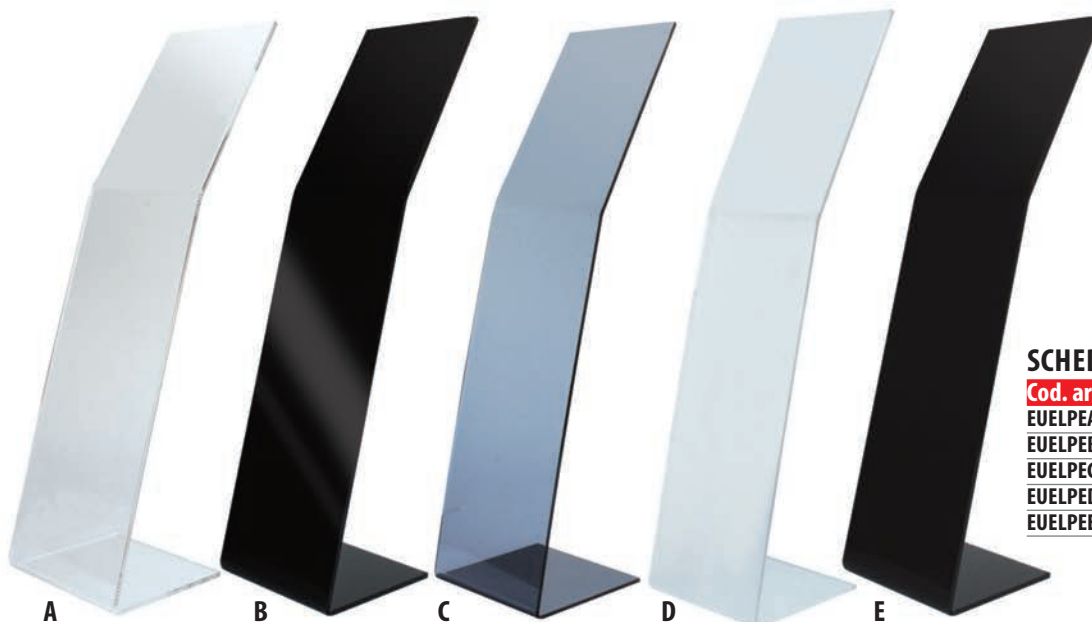

### SCHEDA TECNICA

Cod. art.	Descrizione	L.P.
<b>EUELPEA</b>	EllePerspex trasparente	120
<b>EUELPEB</b>	EllePerspex nero lucido	120
<b>EUELPEC</b>	EllePerspex fumè grigio	120
<b>EUELPED</b>	EllePerspex trasparente bisatinato	120
<b>EUELPEE</b>	EllePerspex nero opaco bisatinato	120

### ELLE PERSPEX TRASPARENTE



### SCHEDA TECNICA

Codice art.	Descrizione	L.P.
<b>EUELPE1</b>	EllePerspex +1 klik-klak A4	130
<b>EUELPE2</b>	EllePerspex +1 klik-klak A4 +1 p.brochure f.to A4	146
<b>EUELPE3</b>	EllePerspex +1 klik-klak A4 +1 p.brochure f.to A5	142
<b>EUELPE4</b>	EllePerspex +1 klik-klak A4 +2 p.brochure f.to 1/3A4	144



### SCHEDA TECNICA

Codice art.	Descrizione	L.P.
<b>EUELPE5</b>	EllePerspex +2 klik-klak A5	134
<b>EUELPE6</b>	EllePerspex +2 klik-klak A5 +1 p.brochure f.to A4	150
<b>EUELPE7</b>	EllePerspex +2 klik-klak A5 +1 p.brochure f.to A5	146
<b>EUELPE8</b>	EllePerspex +2 klik-klak A5 +2 p.brochure f.to 1/3A4	148





**SCHEDA TECNICA**

Codice art.	Descrizione	L.P.
<b>EUELPE13</b>	EllePerspex +1 klik-klak A4	130
<b>EUELPE14</b>	EllePerspex +1 klik-klak A4 +1 p.brochure f.to A4	146
<b>EUELPE15</b>	EllePerspex +1 klik-klak A4 +1 p.brochure f.to A5	142
<b>EUELPE16</b>	EllePerspex +1 klik-klak A4 +2 p.brochure f.to 1/3A4	144



**SCHEDA TECNICA**

Codice art.	Descrizione	L.P.
<b>EUELPE17</b>	EllePerspex +2 klik-klak A5	134
<b>EUELPE18</b>	EllePerspex +2 klik-klak A5 +1 p.brochure f.to A4	150
<b>EUELPE19</b>	EllePerspex +2 klik-klak A5 +1 p.brochure f.to A5	146
<b>EUELPE20</b>	EllePerspex +2 klik-klak A5 +2 p.brochure f.to 1/3A4	148



**ELLE PERSPEX TRASPARENTE BISATINATO**

**SCHEDA TECNICA**

Codice art.	Descrizione	L.P.
<b>EUELPE37</b>	EllePerspex +1 klik-klak A4	130
<b>EUELPE38</b>	EllePerspex +1 klik-klak A4 +1 p.brochure f.to A4	146
<b>EUELPE39</b>	EllePerspex +1 klik-klak A4 +1 p.brochure f.to A5	142
<b>EUELPE40</b>	EllePerspex +1 klik-klak A4 +2 p.brochure f.to 1/3A4	144

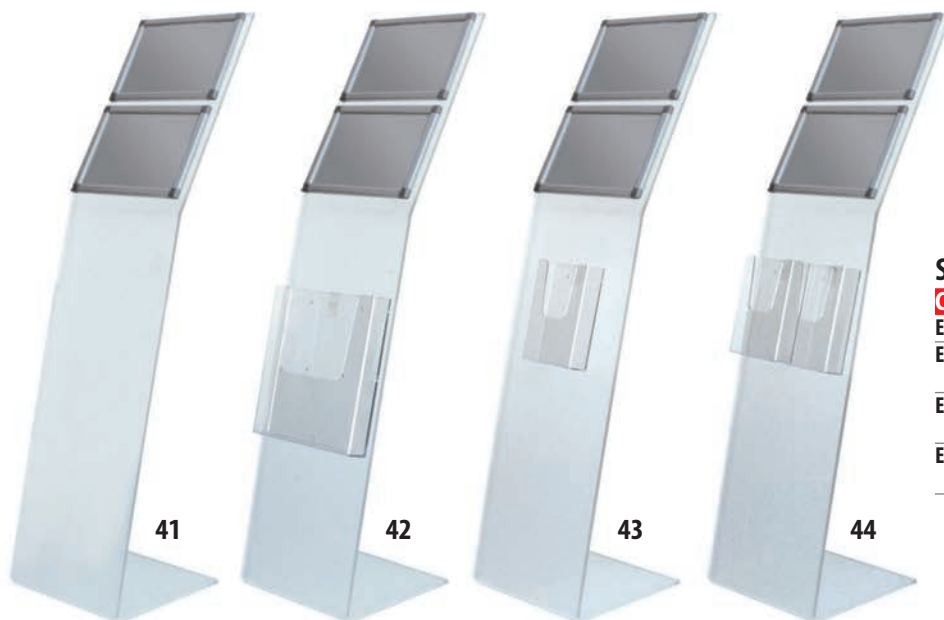

## ELLE PERSPEX TRASPARENTE BISATINATO

## SCHEMA TECNICA

Codice art.	Descrizione	L.P.
EUELPE41	EllePerspex +2 klik-klak A5	134
EUELPE42	EllePerspex +2 klik-klak A5 +1 p.brochure f.to A4	150
EUELPE43	EllePerspex +2 klik-klak A5 +1 p.brochure f.to A5	146
EUELPE44	EllePerspex +2 klik-klak A5 +2 p.brochure f.to 1/3A4	148

## ELLE PERSPEX FUMÈ GRIGIO

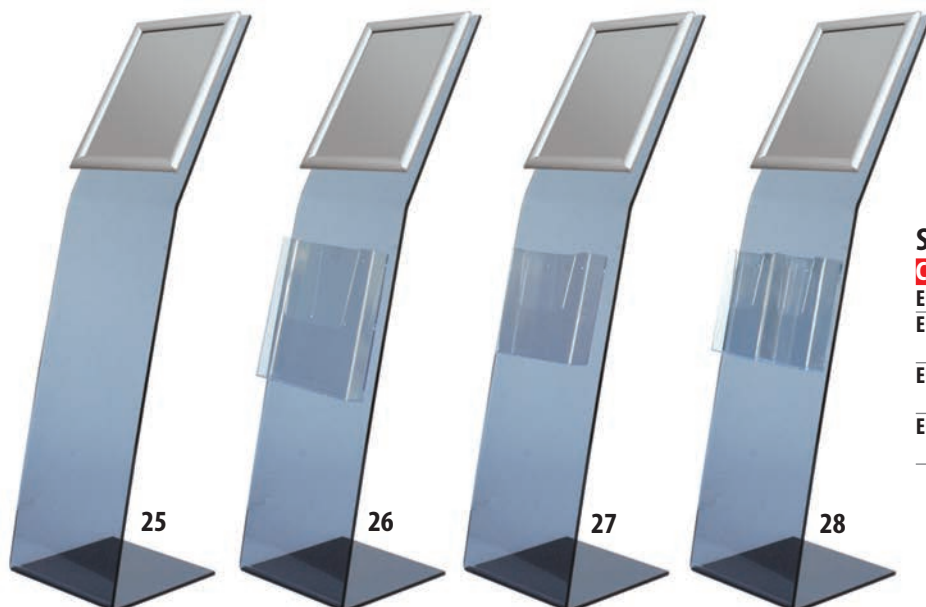

## SCHEMA TECNICA

Codice art.	Descrizione	L.P.
EUELPE25	EllePerspex +1 klik-klak A4	130
EUELPE26	EllePerspex +1 klik-klak A4 +1 p.brochure f.to A4	146
EUELPE27	EllePerspex +1 klik-klak A4 +1 p.brochure f.to A5	142
EUELPE28	EllePerspex +1 klik-klak A4 +2 p.brochure f.to 1/3A4	144

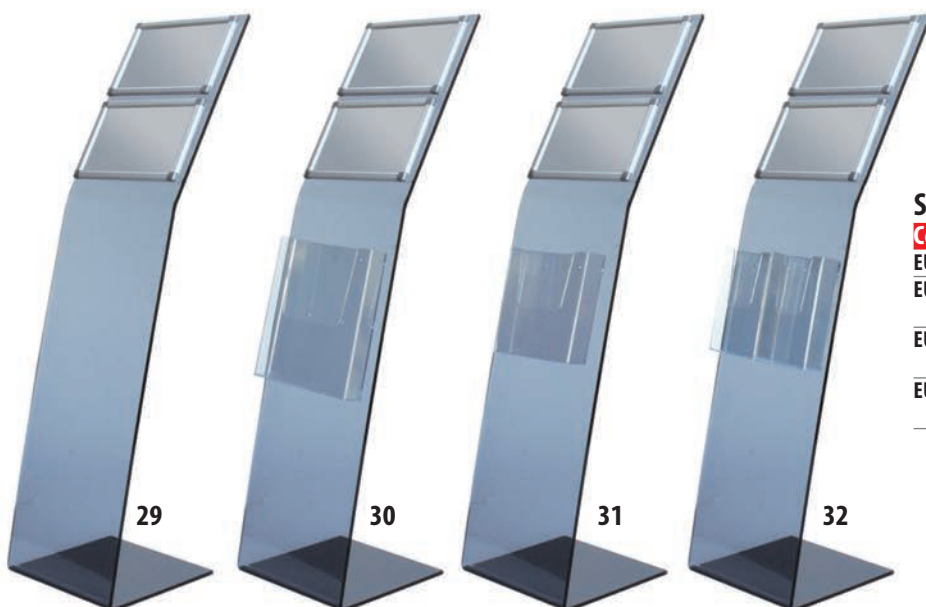

## SCHEMA TECNICA

Codice art.	Descrizione	L.P.
EUELPE29	EllePerspex +2 klik-klak A5	134
EUELPE30	EllePerspex +2 klik-klak A5 +1 p.brochure f.to A4	150
EUELPE31	EllePerspex +2 klik-klak A5 +1 p.brochure f.to A5	146
EUELPE32	EllePerspex +2 klik-klak A5 +2 p.brochure f.to 1/3A4	148

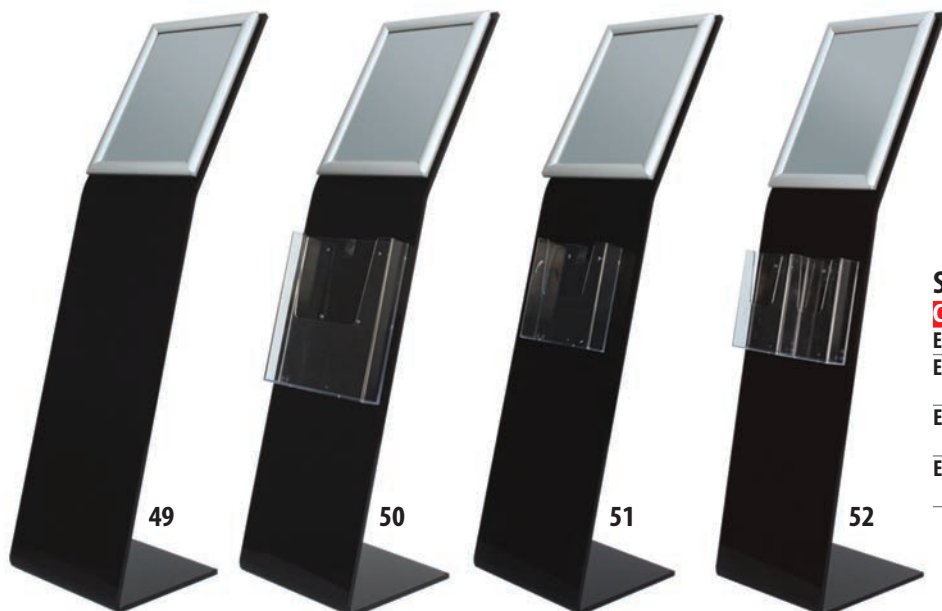

**SCHEMA TECNICA**

Codice art.	Descrizione	L.P.
<b>EUELPE49</b>	EllePerspex +1 klik-klak A4	130
<b>EUELPE50</b>	EllePerspex +1 klik-klak A4 +1 p.brochure f.to A4	146
<b>EUELPE51</b>	EllePerspex +1 klik-klak A4 +1 p.brochure f.to A5	142
<b>EUELPE52</b>	EllePerspex +1 klik-klak A4 +2 p.brochure f.to 1/3A4	144



**SCHEMA TECNICA**

Codice art.	Descrizione	L.P.
<b>EUELPE53</b>	EllePerspex +2 klik-klak A5	134
<b>EUELPE54</b>	EllePerspex +2 klik-klak A5 +1 p.brochure f.to A4	150
<b>EUELPE55</b>	EllePerspex +2 klik-klak A5 +1 p.brochure f.to A5	146
<b>EUELPE56</b>	EllePerspex +2 klik-klak A5 +2 p.brochure f.to 1/3A4	148

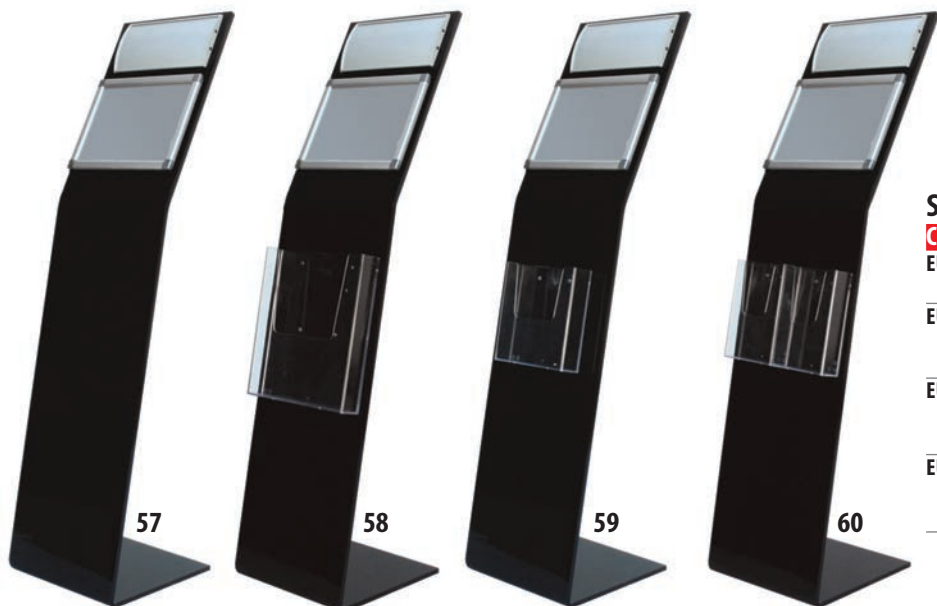

**SCHEMA TECNICA**

Codice art.	Descrizione	L.P.
<b>EUELPE57</b>	EllePerspex +1 klik-klak A5 +1 targa Delta 10x20	148
<b>EUELPE58</b>	EllePerspex +1 klik-klak A5 +1 targa Delta 10x20 +1 p.brochure f.to A4	164
<b>EUELPE59</b>	EllePerspex +1 klik-klak A5 +1 targa Delta 10x20 +1 p.brochure f.to A5	155
<b>EUELPE60</b>	EllePerspex +1 klik-klak A5 +1 targa Delta 10x20 +2 p.brochure f.to 1/3A4	162

# SLIM DEPLIANT & SLIM INFO



Struttura autoportante in lamiera verniciata grigia, piegata a "L" e leggermente inclinata; si possono applicare tramite biadesivo tasche portabrochure, cornici klik klak, targhe Delta, ecc. Disponibile in un unico formato.

*Painted steel grey structure, bent "L" and slightly inclined; can be applied via double-sided pockets portabrochure, frames Klik Klak, Delta plates, etc. Available in one size.*

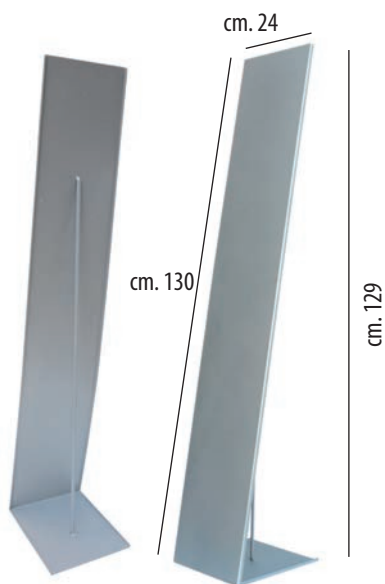

**SLIM INFO**  
speciale per stampe digitali

## SCHEMA TECNICA

Codice art.	Descrizione	L.P.
DSSLIMDE	Slim depliant senza tasche	106
DSSLIMINFO	Slim piantana in lamiera extra liscia per stampa	115



1



2



3



4



5



6



7



8



9

## SCHEDA TECNICA

Codice art.	Descrizione	L.P.
EUSLDEP1	Slim Depliant + 2 tasche p.brochure f.to A4	138
EUSLDEP2	Slim Depliant + 2 tasche p.brochure f.to A5	128
EUSLDEP3	Slim Depliant + 3 tasche p.brochure f.to A5	140
EUSLDEP4	Slim Depliant + 4 tasche p.brochure f.to 1/3 di A4	136

## SCHEDA TECNICA

Codice art.	Descrizione	L.P.
EUSLDEP5	Slim Depliant + 1 cornice klik-klak f.to A4	116
EUSLDEP6	Slim Depliant + 2 cornici klik-klak f.to A4	126
EUSLDEP7	Slim Depliant + 2 cornici klik-klak f.to A5	120
EUSLDEP8	Slim Depliant + 3 cornici klik-klak f.to A5	128
EUSLDEP9	Slim Depliant + 4 cornici klik-klak f.to A5	135

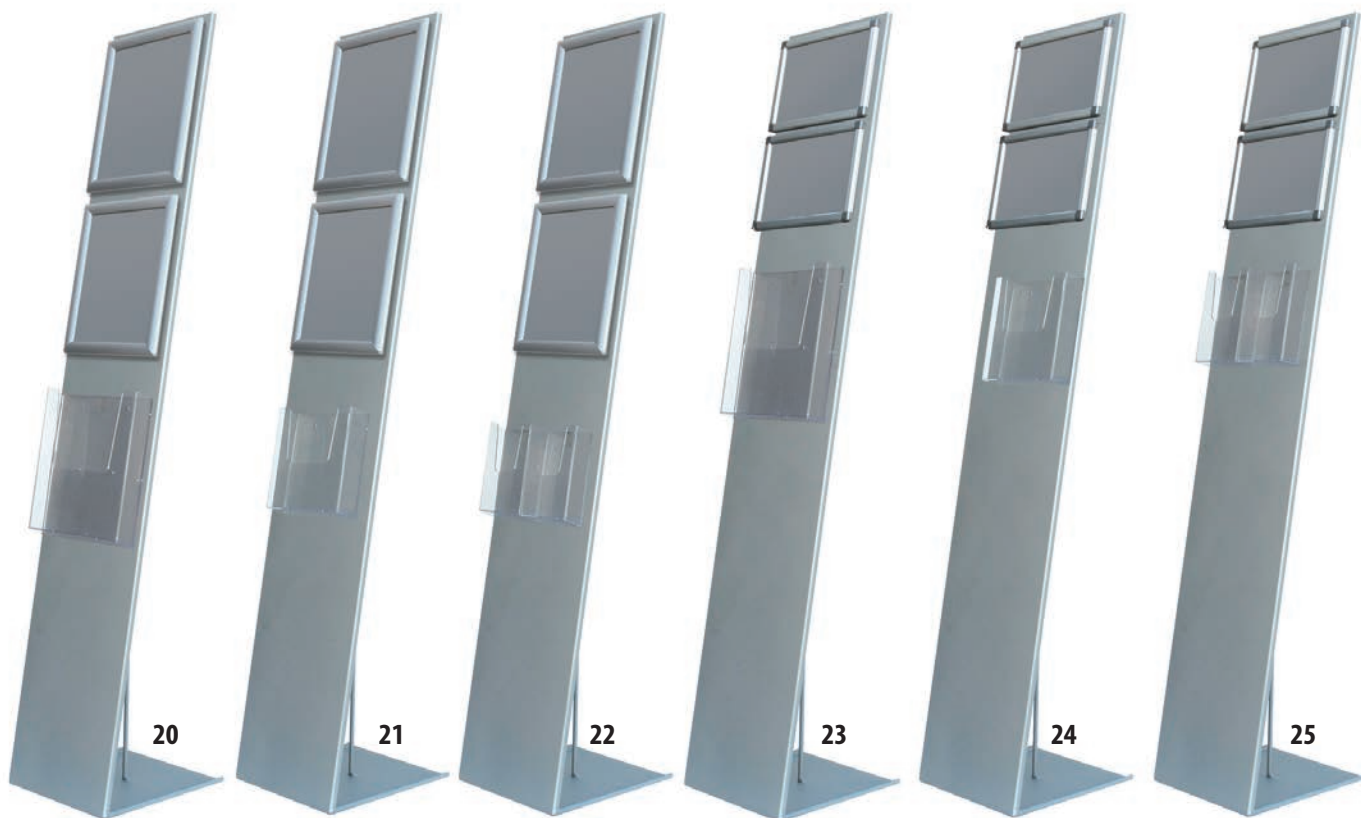

**SCHEMA TECNICA**

Codice art.	Descrizione	L.P.
<b>EUSLDEP15</b>	Slim Depliant + 1 klik-klak f.to A4 + 1 p.brochure f.to A4	132
<b>EUSLDEP16</b>	Slim Depliant + 1 klik-klak f.to A4 + 1 p.brochure f.to A5	128
<b>EUSLDEP17</b>	Slim Depliant + 1 klik-klak f.to A4 + 2 p.brochure f.to 1/3 di A4	130
<b>EUSLDEP18</b>	Slim Depliant + 1 klik-klak f.to A4 + 2 p.brochure f.to A5	138
<b>EUSLDEP19</b>	Slim Depliant + 1 klik-klak f.to A4 + 4 p.brochure f.to 1/3 di A4	145

**SCHEMA TECNICA**

Codice art.	Descrizione	L.P.
<b>EUSLDEP20</b>	Slim Depl. + 2 klik-klak f.to A4 + 1 p.brochure f.to A4	142
<b>EUSLDEP21</b>	Slim Depl. + 2 klik-klak f.to A4 + 1 p.brochure f.to A5	136
<b>EUSLDEP22</b>	Slim Depl. + 2 klik-klak f.to A4 + 2 p.brochure f.to 1/3 di A4	140
<b>EUSLDEP23</b>	Slim Depl. + 2 klik-klak f.to A5 + 1 p.brochure f.to A4	136
<b>EUSLDEP24</b>	Slim Depl. + 2 klik-klak f.to A5 + 1 p.brochure f.to A5	132
<b>EUSLDEP25</b>	Slim Depl. + 2 klik-klak f.to A5 + 2 p.brochure f.to 1/3 di A4	134



# SEGNALETICA

ECONOMY SISTEMA ARIANNA  
E ARIANNA LIGHT  
TARGHE INDUSTRY  
TARGHE ALLUMINIO  
SISTEMA DELTA  
TUTTOTARGHE STYLE  
TUTTOTARGHE  
DISTANZIALI  
STAFFE TARGHE PARETE/BANDIERA  
PORTATARGA LED  
US STANDING  
SISTEMI DI FISSAGGIO A SOSPENSIONE  
SISTEMI DI FISSAGGIO TIRANTI  
SISTEMI DI FISSAGGIO ACCIAIO/ELITE  
VELAPLEX  
SISTEMI DI FISSAGGIO RIGIDO  
SISTEMI DI FISSAGGIO QUADRI  
MAGNETIC LIGHTBOX



# ECONOMY SISTEMA ARIANNA

## SISTEMA ARIANNA MONOFACCIALE FORMATI STANDARD

Per un semplice montaggio è sufficiente inserire il messaggio tra il supporto estraibile e la protezione antiriflesso, richiudere il tutto con il telaio ed infine fissare con biadesivo o stop al muro, porta, ecc. Disponibile nei tre colori Grigio chiaro, Grigio scuro e Argento.

*For a simple installation, simply insert the message between removable media and the anti-reflection coat, close all with the chassis and finally secure with double sided tape or stop the wall, door, etc. Available in three colors: light grey, dark grey and silver.*



### SCHEDE TECNICHE SISTEMA ARIANNA MONOFACCIALE FORMATI STANDARD

Codice Art. Bianco	Codice Art. Grigio scuro	Misure Telaio mm.	L.P.
EUAM1010G	EUAM1010GS	108x108	11
EUAM1018G	EUAM1018GS	108x180	12
EUAM1414G	EUAM1414GS	144x144	13
EUAM1418G	EUAM1418GS	144x180	14
EUAM1430G	EUAM1430GS	144x302	22
EUAM1442G	EUAM1442GS	144x425	26
EUAM1450G	EUAM1450GS	144x505	28
EUAM1460G	EUAM1460GS	144x599	32
EUAM1471G	EUAM1471GS	144x712	35
EUAM1484G	EUAM1484GS	144x845	40
EUAM14100G	EUAM14100GS	144x1005	45
EUAM14120G	EUAM14120GS	144x1194	51
EUAM1818G	EUAM1818GS	180x180	15
EUAM2121G	EUAM2121GS	215x215	22
EUAM2142G	EUAM2142GS	215x425	32
EUAM2150G	EUAM2150GS	215x505	37
EUAM2160G	EUAM2160GS	215x599	41
EUAM2171G	EUAM2171GS	215x712	47
EUAM2184G	EUAM2184GS	215x845	53
EUAM21100G	EUAM21100GS	215x1005	61
EUAM21120G	EUAM21120GS	215x1194	69
EUAM3030G	EUAM3030GS	302x302	32
EUAM3050G	EUAM3050GS	302x505	46
EUAM3060G	EUAM3060GS	302x599	53
EUAM3071G	EUAM3071GS	302x712	61
EUAM3084G	EUAM3084GS	302x845	69
EUAM30100G	EUAM30100GS	302x1005	80
EUAM30120G	EUAM30120GS	302x1194	93
EUAM4242G	EUAM4242GS	425x425	5

Codice Art. Bianco	Codice Art. Grigio scuro	Misure Telaio mm.	L.P.
EUAM4260G	EUAM4260GS	425x599	79
EUAM4271G	EUAM4271GS	425x712	90
EUAM4284G	EUAM4284GS	425x845	102
EUAM42100G	EUAM42100GS	425x1005	118
EUAM42120G	EUAM42120GS	425x1194	135
EUAM5050G	EUAM5050GS	505x505	79
EUAM5060G	EUAM5060GS	505x599	90
EUAM5071G	EUAM5071GS	505x712	103
EUAM5084G	EUAM5084GS	505x845	118
EUAM50100G	EUAM50100GS	505x1005	135
EUAM50120G	EUAM50120GS	505x1194	157
EUAM6060G	EUAM6060GS	599x599	103
EUAM6071G	EUAM6071GS	599x712	118
EUAM6084G	EUAM6084GS	599x845	135
EUAM60100G	EUAM60100GS	599x1005	156
EUAM60120G	EUAM60120GS	599x1194	182
EUAM7171G	EUAM7171GS	712x712	135
EUAM7184G	EUAM7184GS	712x845	156
EUAM71100G	EUAM71100GS	712x1005	181
EUAM71120G	EUAM71120GS	712x1194	212
EUAM71142G	EUAM71142GS	712x1419	248
EUAM8484G	EUAM8484GS	845x845	182
EUAM84100G	EUAM84100GS	845x1005	212
EUAM84120G	EUAM84120GS	845x1194	248
EUAM84142G	EUAM84142GS	845x1419	290
EUAM100100G	EUAM100100GS	1005x1005	248
EUAM100120G	EUAM100120GS	1005x1194	290
EUAM100142G	EUAM100142GS	1005x1419	340

## SISTEMA ARIANNA BIFACCIALE A BANDIERA FORMATI STANDARD



### SCHEDE TECNICHE BIFACCIALI A BANDIERA

Codice Art. Bianco	Codice Art. Grigio scuro	Misure Telaio mm.	L.P.
EUSAB1414G	EUSAB1414GS	144x144	31
EUSAB1418G	EUSAB1418GS	144x180	32
EUSAB1430G	EUSAB1430GS	144x302	50
EUSAB1442G	EUSAB1442GS	144x425	57
EUSAB1450G	EUSAB1450GS	144x505	62
EUSAB1818G	EUSAB1818GS	180x180	36
EUSAB2121G	EUSAB2121GS	215x215	50
EUSAB2130G	EUSAB2130GS	215x302	60
EUSAB2142G	EUSAB2142GS	215x425	70
EUSAB2150G	EUSAB2150GS	215x505	78
EUSAB3030G	EUSAB3030GS	302x302	70
EUSAB3042G	EUSAB3042GS	302x425	87
EUSAB3050G	EUSAB3050GS	302x505	98
EUSAB4242G	EUSAB4242GS	425x425	110

ALTRE MISURE SU RICHIESTA



# ECONOMY SISTEMA ARIANNA LIGHT



## SCHEDA TECNICA MONOFACCIALI LIGHT

Codice Art. Grigio chiaro	Codice Art. Grigio scuro	Codice Art. Nero	Misure Telaio mm.	L.P.
EUAL1172G	EUAL1172GS	EUAL1172N	108x72	7
EUAL1111G	EUAL1111GS	EUAL1111N	108x108	8
EUAL1118G	EUAL1118GS	EUAL1118N	108x180	10
EUAL1470G	EUAL1470GS	EUAL1470N	144x72	9
EUAL1411G	EUAL1411GS	EUAL1411N	144x108	10
		EUAL1414N	144x144	11
EUAL1418G	EUAL1418GS	EUAL1418N	144x180	12
EUAL1870G	EUAL1870GS	EUAL1870N	180x72	7
EUAL1818G	EUAL1818GS	EUAL1818N	180x180	12

## SISTEMA ARIANNA BIFACCIALE A SOSPENSIONE



## SCHEDA TECNICA

Codice Art.	Misure cm.	L.P.
EUSAS1460	14x60	74
EUSAS14100	14x100	103
EUSAS14142	14x142	135
EUSAS2160	21x60	95
EUSAS21100	21x100	141
EUSAS21142	21x142	186
EUSAS3060	30x60	122
EUSAS30100	30x100	185
EUSAS30142	30x142	250
EUSAS4260	42x60	184
EUSAS42100	42x100	272
EUSAS42142	42x142	363



ALTRE MISURE SU RICHIESTA

# TARGHE INDUSTRY

Soluzione per segnaletica stradale e cantieristica composta da tabelle in lamiera spess. 10/10, colore grigio industriale, in varie dimensioni e predisposte per fissaggio ai pali. Su richiesta è possibile avere anche le staffe, la bulloneria ed i pali in ferro zincato diametro mm. 48 e mm. 60.

*Solution for road signs and shipbuilding made up from tables sheet thickness 10/10, industrial gray, in various sizes and arranged for attachment to the posts. On request you can also have the brackets, bolts and galvanized iron poles diameter 48 mm and 60.*

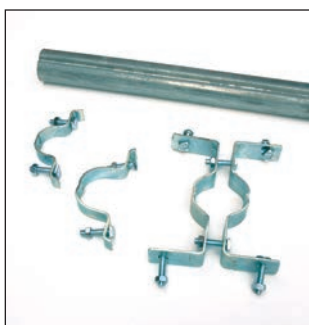

## SCHEDA TECNICA TARGHE INDUSTRY

Codice art.	Dim. mm	N° attacchi/canali	Pezzi per conf.	Colore	L.P. cad.	L.P. conf.
TBTAB20100	Targa 200x1000	2 attacchi	8	Grigio	24	192
TBTAB25100	Targa 250x1000	2 attacchi	8	Grigio	26	208
TBTAB25125	Targa 250x1250	4 attacchi	8	Grigio	25	200
TBTAB100150	Targa 1000x1500	4 canali	2	Grigio	148	296
TBTAB4060	Targa 400x600	4 attacchi	8	Grigio	18	144
TBTAB6090	Targa 600x900	4 attacchi	6	Grigio	36	216
TBTAB100200	Targa 1000x2000	4 canali	2	Grigio	272	544
TBTAB150200	Targa 1500x2000	4 canali	2	Grigio	288	576
TBTAB6060	Targa 600x600	2 attacchi	8	Grigio	24	192
TBTAB4040	Targa 400x400	2 attacchi	8	Grigio	20	160
TBTAB2780	Targa 270x800	2 attacchi	8	Grigio	16	128
TBTAB1535	Pannelli integrativi 15x35	1 attacco	-	Grigio	9	-
TBSTMO48	Staffa monof. Ø48 + bulloni	-	20	Silver	1.60	32
TBSTMO60	Staffa monof. Ø60 + bulloni	-	20	Silver	1.60	32
TBSTBI48	Staffa bifacc. Ø48 + bulloni	-	10	Silver	4.90	49,90
TBSTBI60	Staffa bifac. Ø60 + bulloni	-	10	Silver	5	50
TBPALO48	Palo Ø 48 x L 3000 + tappo	-	3	Silver	45	135
TBPALO60	Palo Ø 60 x L 3000 + tappo	-	3	Silver	54	162
TBPALO60XL	Palo Ø 60 x L 3300 + tappo	-	3	Silver	60	180

### SCHEDA TECNICA TARGHE LAMIERA CIRCOLARI

Codice art.	Diametro cm.	N° attacchi/canali	Colore	L.P.
TBTABC40	40	2 attacchi	Grigio	14
TBTABC60	60	2 attacchi	Grigio	21
TBTABC608	60	8 attacchi	Grigio	30
TBTABC90	90	2 canali	Grigio	57

### SCHEDA TECNICA TARGHE LAMIERA OTTAGONALI

Codice art.	Diagonale cm.	N° attacchi/canali	Colore	L.P.
TBTAB060	60	2 attacchi	Grigio	25
TBTAB090	90	2 canali	Grigio	70

### SCHEDA TECNICA TARGHE LAMIERA TRIANGOLARI

Codice art.	Dim. cm.	N° attacchi/canali	Colore	L.P.
TBTABTR60	60x60x60	2 attacchi	Grigio	14
TBTABTR90	90x90x90	2 attacchi	Grigio	20
TBTABTR120	120x120x120	2 canali	Grigio	54

### SCHEDA TECNICA TARGHE LAMIERA A FRECCIA

Codice art.	Dim. cm.	N° attacchi/canali	Colore	L.P.
TBTABF30130	30x130	2 canali	Grigio	47
TBTABF40150	40x150	2 canali	Grigio	60



### SCHEDA TECNICA PIANTANA MOBILE

Codice art.	Diametro piantana cm.	Diametro palo mm.	Altezza palo cm.	L.P.
TBPIAMO60	60	60	200	120

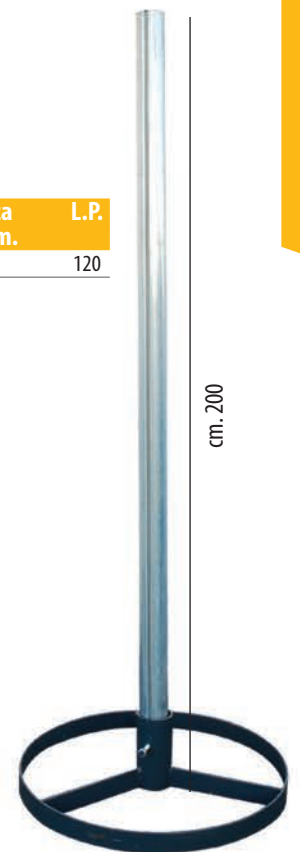

### SCHEDA TECNICA ARCHETTO

Codice art.	Dim archetto cm.	Diametro tubo mm.	Dim. targa cm.	L.P.
TBARCH	115x100	60	87x50	276

## AUTOADESIVI RIFRANGENTI PER CARTELLI H CM 122

ORALITE SERIE 5500 ENGINEER GRADE

010 WHITE	020 YELLOW	035 ORANGE	030 RED	060 GREEN	050 BLUE										
080 BROWN	070 BLACK	<b>SCHEDA TECNICA</b> <table border="1"> <thead> <tr> <th>Codice serie</th> <th>Colori</th> <th>Altezza cm.</th> <th>Lunghezza mtl.</th> <th>L.P./mtl</th> </tr> </thead> <tbody> <tr> <td>5500-Engineer Grade</td> <td>vari</td> <td>122</td> <td>50</td> <td>26</td> </tr> </tbody> </table>				Codice serie	Colori	Altezza cm.	Lunghezza mtl.	L.P./mtl	5500-Engineer Grade	vari	122	50	26
Codice serie	Colori	Altezza cm.	Lunghezza mtl.	L.P./mtl											
5500-Engineer Grade	vari	122	50	26											

# TARGHE ALLUMINIO

Targhe in alluminio per segnaletica stradale, toponomastica ed indicatoria aziendale; disponibile sia monofacciale che bifacciale, possibilità di fissaggio su palo singolo o tra due pali di sezione mm. 48 e mm. 60 in ferro, mm. 80 in alluminio.

*Targhe Aluminum road signs, place names and indicatoria company; available in both single-sided to double-sided, single-pole mounting options on or between two posts of section mm. And 48 mm. 60, iron mm. 80 aluminu.*

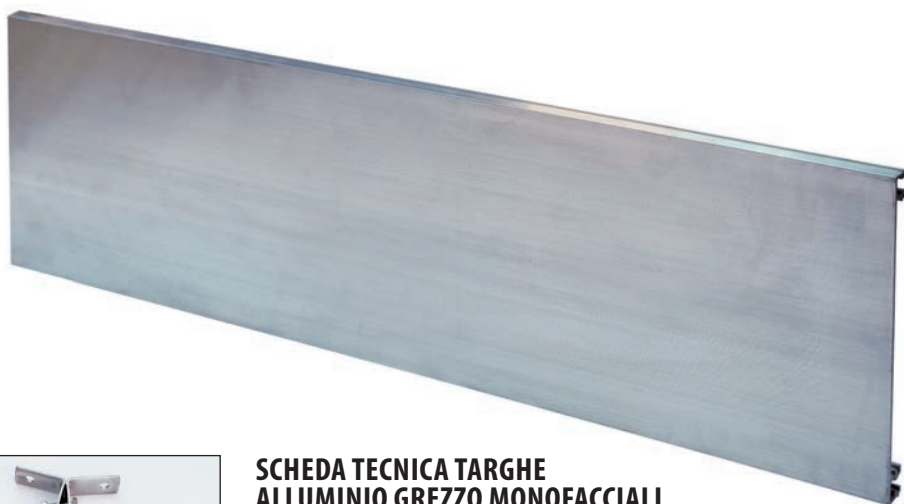

## MONOFACCIALI



### SCHEDA TECNICA TARGHE ALLUMINIO GREZZO MONOFACCIALI

Codice Articolo	Dimensioni mm.	L.P.
NLTALM020100	Targa 200x1000	50
NLTALM025100	Targa 250x1000	58
NLTALM025125	Targa 250x1250	70
TBSTM048	Staffa Ø 48 + bulloni	1,60
TBSTM060	Staffa Ø 60 + bulloni	1,60
TBSTBI60	Staffa Ø 60 + bulloni	5
TBPALO48	Palo Ø 48 x L 3000 + tappo	45
TBPALO60	Palo Ø 60 x L 3000 + tappo	54
TBPALO60XL	Palo Ø 60 x L 3300 + tappo	60

## BIFACCIALI A BANDIERA

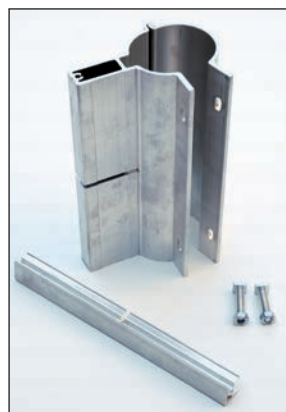
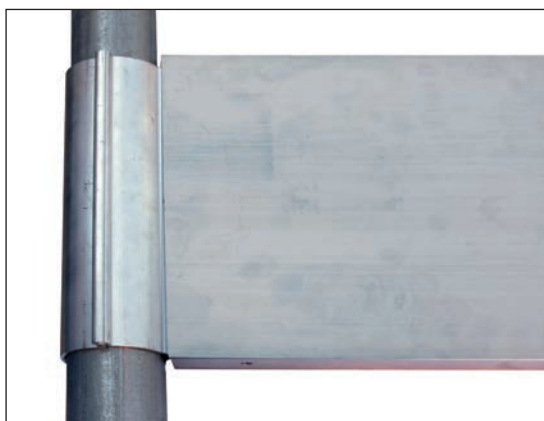

### SCHEDA TECNICA TARGHE ALLUMINIO GREZZO BIFACCIALI

Codice Articolo	Dimensioni mm.	L.P.
NLTALBI20100	Targa 200x1000	66
NLTALBI2580	Targa 250x800	58
NLTALBI25100	Targa 250x1000	76
NLTALBI25125	Targa 250x1250	91
NLSTAMAXI20	Staffa per targa H 200	20
NLSTAMAXI25	Staffa per targa H 250	25
NLTAAL20	Tappo per targa H 200	6
NTAAL25	Tappo per targa H 250	7
TBPALO60	Palo Ø 60 x L 3000 + tappo	54
TBPALO60XL	Palo Ø 60 x L 3300 + tappo	60

## BIFACCIALI



### SCHEDA TECNICA TARGHE ALLUMINIO GREZZO BIFACCIALI

Codice Articolo	Dimensioni mm.	L.P.
NLTALBI20100	Targa 200x1000	66
NLTALBI2580	Targa 250x800	58
NLTALBI25100	Targa 250x1000	76
NLTALBI25125	Targa 250x1250	91
NLSTA8020	Staffa per targa H 200, palo Ø 80	15
NLSTA8025	Staffa per targa H 250, palo Ø 80	18
NLTAAL20	Tappo per targa H 200	6
NLTAAL25	Tappo per targa H 250	6,50
NLPAAL802	Palo Ø 80 x L 3000, 2 vie	140
NLPAAL804	Palo Ø 80 x L 3000, 4 vie	170
NLTANE80	Tappo per palo 1801/1802	7

# SISTEMA DELTA

## SISTEMA DELTA MONOFACCIALE

Targhe monofacciali in alluminio silver, sezione curva, con tappi in acrilico nero e film protettivo in pvc antiriflesso; posizionabili sia in verticale che in orizzontale, sono indicate per la segnaletica direzionale, di sicurezza, ecc.

*Single-sided aluminum silver plates, curved section, with caps in black acrylic and PVC anti-reflective protective film; can be positioned either vertically or horizontally, are suitable for directional signage, security, etc.*



### SCHEDA TECNICA SERIE 40

Codice Articolo	Dimensioni cm.	L.P.
EUDLT44	4x4	8
EUDLT410	4x10	11
EUDLT415	4x15	13
EUDLT420	4x20	16
EUDLT430	4x30	20
EUDLT440	4x40	23



### SCHEDA TECNICA SERIE 80

Codice Articolo	Dimensioni cm.	L.P.
EUDLT810	8x10	17
EUDLT815	8x15	20
EUDLT820	8x20	21
EUDLT830	8x30	23
EUDLT840	8x40	26
EUDLT850	8x50	28

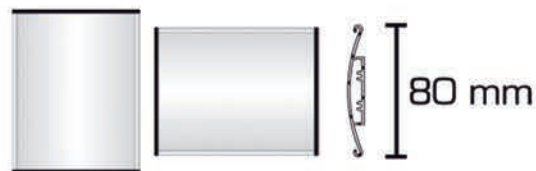

### SCHEDA TECNICA SERIE 100

Codice Articolo	Dimensioni cm.	L.P.
EUDLT105	10x5	15
EUDLT1010	10x10	16
EUDLT1015	10x15	18
EUDLT1020	10x20	21
EUDLT1030	10x30	23
EUDLT1040	10x40	30



**ALTRE MISURE SU RICHIESTA**

### SCHEDA TECNICA SERIE 120

Codice Articolo	Dimensioni cm.	L.P.
EUDLT125	12x5	18
EUDLT1212	12x12	22
EUDLT1220	12x20	26
EUDLT1225	12x25	28
EUDLT1230	12x30	32
EUDLT1250	12x50	43



### SCHEDA TECNICA SERIE 150

Codice Articolo	Dimensioni cm.	L.P.
EUDLT158	15x8	22
EUDLT1515	15x15	25
EUDLT1521	15x21	27
EUDLT1530	15x30	38
EUDLT1540	15x40	44
EUDLT1550	15x50	50

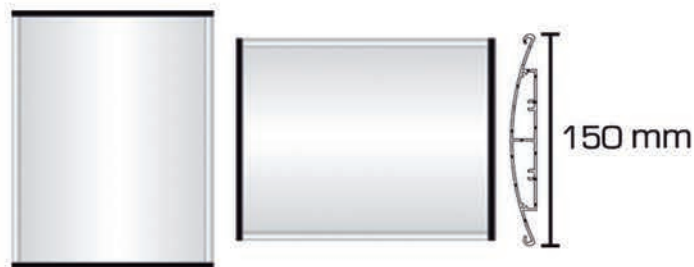

### SCHEDA TECNICA SERIE 200

Codice Articolo	Dimensioni cm.	L.P.
EUDLT208	20x8	23
EUDLT2012	20x12	26
EUDLT2020	20x20	34
EUDLT2030	20x30	40
EUDLT2040	20x40	50
EUDLT2050	20x50	58



### SCHEDA TECNICA SERIE 300

Codice Articolo	Dimensioni cm.	L.P.
EUDLT3010	30x10	39
EUDLT3015	30x15	42
EUDLT3021	30x21	46
EUDLT3030	30x30	65
EUDLT3042	30x42	82
EUDLT3050	30x50	107



### SCHEDA TECNICA SERIE 400

Codice Articolo	Dimensioni cm.	L.P.
EUDLT4010	40x10	52
EUDLT4015	40x15	60
EUDLT4020	40x20	65
EUDLT4030	40x30	98
EUDLT4040	40x40	120
EUDLT4050	40x50	142

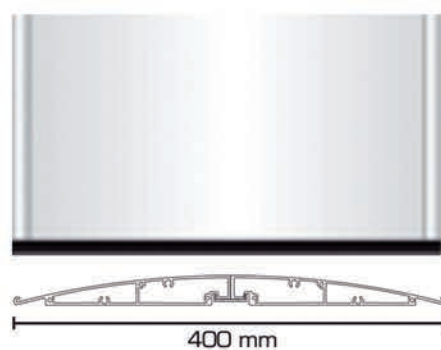

# SISTEMA DELTA

## SISTEMA DELTA BIFACCIALE

Targhe bifacciali in alluminio silver, sezione curva, tappi in acrilico nero e film protettivo in pvc antiriflesso; posizionabile a bandiera su muro, sia in orizzontale che in verticale per segnaletica direzionale, di sicurezza, ecc.

*Targhe Double sided aluminum silver, curved section, caps in black acrylic and PVC anti-reflective protective film; positionable flag on the wall, either horizontally or vertically for directional signage, security, etc.*



### SCHEDA TECNICA

Codice Articolo	Dimensioni cm.	L.P.
EUDLTB1212	12x12	80
EUDLTB1212A	12x12	80
EUDLTB1515	15x15	86
EUDLTB1515A	15x15	86
EUDLTB2015	20x15	92
EUDLTB2015A	20x15	98
EUDLTB1215	12x15	84
EUDLTB1215A	12x15	84
EUDLTB2020	20x20	112

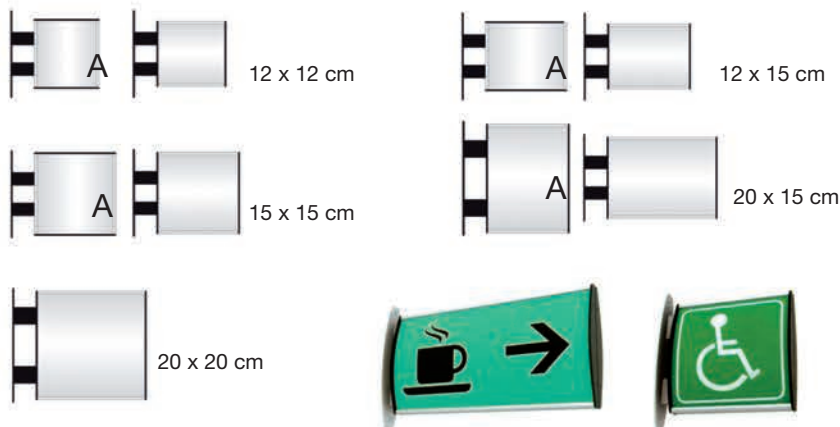

## SISTEMA DELTA DESK

Portanome da scrivania in alluminio anodizzato silver, con base in materiale plastico nero e film protettivo in pvc antiriflesso.

*Badges desk anodized aluminum silver, with base in black plastic protective film anti-reflective PVC.*

### SCHEDA TECNICA

Codice Articolo	Dimensioni cm.	L.P.
EUULD810	8x10	25
EUULD815	8x15	29
EUULD820	8x20	32
EUULD830	8x30	36
EUULD1010	10x10	25
EUULD1015	10x15	28
EUULD1020	10x20	31
EUULD1030	10x30	39



## SISTEMA DELTA TABLE

Targhe da tavolo in alluminio anodizzato silver e base in Perspex nero.

*Plates table in anodized aluminum base silver and black Perspex.*

### SCHEDA TECNICA

Codice Art.	Dimensioni cm.	L.P.
EUDT815	8x15	40
EUDT1020	10x20	45
EUDT1521	15x21	65





# TUTTOTARGHE STYLE



NERO

BIANCO LUCIDO

IMPRESSION FUMÈ

## SCHEDA TECNICA TARGHE PERSPEX NERO LUCIDO MM.5

Codice Art.	Dimensioni cm.	L.P.
EUTAPXN2010	20X10 con 2 fori	7
EUTAPXN2015	20X15 con 4 fori	8
EUTAPXN3020	30x20 con 4 fori	10
EUTAPXN3525	35x25 con 4 fori	15
EUTAPXN4030	40x30 con 4 fori	23
EUTAPXN5025	50x25 con 4 fori	23
EUTAPXN5035	50x35 con 4 fori	34
EUTAPXN5050	50x50 con 4 fori	45
EUTAPXN6040	60x40 con 4 fori	53
EUTAPXN7050	70x50 con 4 fori	60

## SCHEDA TECNICA TARGHE PERSPEX ULTRA BIANCO LUCIDO MM.5

Codice Art.	Dimensioni cm.	L.P.
EUTAPXB2010	20X10 con 2 fori	7
EUTAPXB2015	20X15 con 4 fori	8
EUTAPXB3020	30x20 con 4 fori	10
EUTAPXB3525	35x25 con 4 fori	15
EUTAPXB4030	40x30 con 4 fori	23
EUTAPXB5025	50x25 con 4 fori	23
EUTAPXB5035	50x35 con 4 fori	34
EUTAPXB5050	50x50 con 4 fori	45
EUTAPXB6040	60x40 con 4 fori	53
EUTAPXB7050	70x50 con 4 fori	60

## SCHEDA TECNICA TARGHE PERSPEX IMPRESSION FUMÈ' MM.5

Codice Art.	Dimensioni cm.	L.P.
EUTAIFI2010	20x10 con 2 fori	7
EUTAIFI2015	20X15 con 4 fori	8
EUTAIFI3020	30x20 con 4 fori	10
EUTAIFI3525	35x25 con 4 fori	15
EUTAIFI4030	40x30 con 4 fori	23
EUTAIFI5025	50x25 con 4 fori	23
EUTAIFI5035	50x35 con 4 fori	34
EUTAIFI5050	50x50 con 4 fori	45
EUTAIFI6040	60x40 con 4 fori	53
EUTAIFI7050	70x50 con 4 fori	60

ALTRE MISURE SU RICHIESTA

# TUTTOTARGHE STYLE



BIANCO OPACO

## SCHEDA TECNICA TARGHE PERSPEX ULTRA BIANCO OPACO MM.5

Codice Art.	Dimensioni cm.	L.P.
EUTAPXBM2010	20x10 con 2 fori	7
EUTAPXBM2015	20x15 con 4 fori	8
EUTAPXBM3020	30x20 con 4 fori	10
EUTAPXBM3525	35x25 con 4 fori	15
EUTAPXBM4030	40x30 con 4 fori	23
EUTAPXBM5025	50x25 con 4 fori	23
EUTAPXBM5035	50x35 con 4 fori	34
EUTAPXBM5050	50x50 con 4 fori	45
EUTAPXBM6040	60x40 con 4 fori	53
EUTAPXBM7050	70x50 con 4 fori	60



NERO OPACO

## SCHEDA TECNICA TARGHE PERSPEX NERO OPACO MM.5

Codice Art.	Dimensioni cm.	L.P.
EUTAPXNM2010	20x10 con 2 fori	7
EUTAPXNM2015	20x15 con 4 fori	8
EUTAPXNM3020	30x20 con 4 fori	10
EUTAPXNM3525	35x25 con 4 fori	15
EUTAPXNM4030	40x30 con 4 fori	23
EUTAPXNM5025	50x25 con 4 fori	23
EUTAPXNM5035	50x35 con 4 fori	34
EUTAPXNM5050	50x50 con 4 fori	45
EUTAPXNM6040	60x40 con 4 fori	53
EUTAPXNM7050	70x50 con 4 fori	60



TRASPARENTE OPACO

## SCHEDA TECNICA TARGHE PERSPEX TRASPARENTE OPACO MM.5

Codice Art.	Dimensioni cm.	L.P.
EUTAPXTM2010	20x10 con 2 fori	7
EUTAPXTM2015	20x15 con 4 fori	8
EUTAPXTM3020	30x20 con 4 fori	10
EUTAPXTM3525	35x25 con 4 fori	15
EUTAPXTM4030	40x30 con 4 fori	23
EUTAPXTM5025	50x25 con 4 fori	23
EUTAPXTM5035	50x35 con 4 fori	34
EUTAPXTM5050	50x50 con 4 fori	45
EUTAPXTM6040	60x40 con 4 fori	53
EUTAPXTM7050	70x50 con 4 fori	60

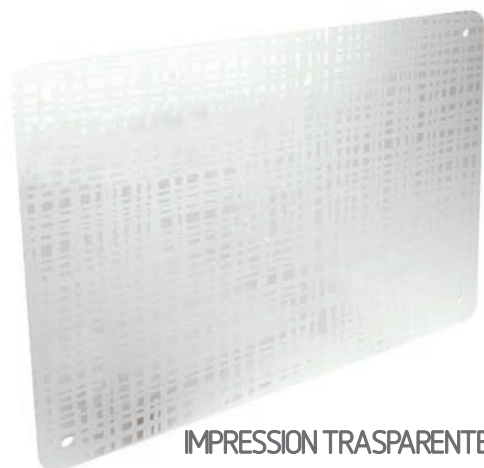

IMPRESSION TRASPARENTE

## SCHEDA TECNICA TARGHE PERSPEX IMPRESSION TRASPARENTE MM.5

Codice Art.	Dimensioni cm.	L.P.
EUTAPXIT2010	20x10 con 2 fori	7
EUTAPXIT2015	20x15 con 4 fori	8
EUTAPXIT3020	30x20 con 4 fori	10
EUTAPXIT3525	35x25 con 4 fori	15
EUTAPXIT4030	40x30 con 4 fori	23
EUTAPXIT5025	50x25 con 4 fori	23
EUTAPXIT5035	50x35 con 4 fori	34
EUTAPXIT5050	50x50 con 4 fori	45
EUTAPXIT6040	60x40 con 4 fori	53
EUTAPXIT7050	70x50 con 4 fori	60



FUMÈ

## SCHEDA TECNICA TARGHE PERSPEX FUME' MM.5

Codice Art.	Dimensioni cm.	L.P.
EUTAPXFU2010	20x10 con 2 fori	7
EUTAPXFU2015	20x15 con 4 fori	8
EUTAPXFU3020	30x20 con 4 fori	10
EUTAPXFU3525	35x25 con 4 fori	15
EUTAPXFU4030	40x30 con 4 fori	23
EUTAPXFU5025	50x25 con 4 fori	23
EUTAPXFU5035	50x35 con 4 fori	34
EUTAPXFU5050	50x50 con 4 fori	45
EUTAPXFU6040	60x40 con 4 fori	53
EUTAPXFU7050	70x50 con 4 fori	60



ORO BRILLANTE

## SCHEDA TECNICA TARGHE PERSPEX DUO ORO BRILLANTE MM.3

Codice Art.	Dimensioni cm.	L.P.
EUTAPXD02010	20x10 con 2 fori	7
EUTAPXD02015	20x15 con 4 fori	8
EUTAPXD03020	30x20 con 4 fori	10
EUTAPXD03525	35x25 con 4 fori	15
EUTAPXD04030	40x30 con 4 fori	23
EUTAPXD05025	50x25 con 4 fori	23
EUTAPXD05035	50x35 con 4 fori	34
EUTAPXD05050	50x50 con 4 fori	45
EUTAPXD06040	60x40 con 4 fori	53
EUTAPXD07050	70x50 con 4 fori	60

ALTRE MISURE SU RICHIESTA

# TUTTOTARGHE STYLE



ARGENTO BRILLANTE



SPECCHIO

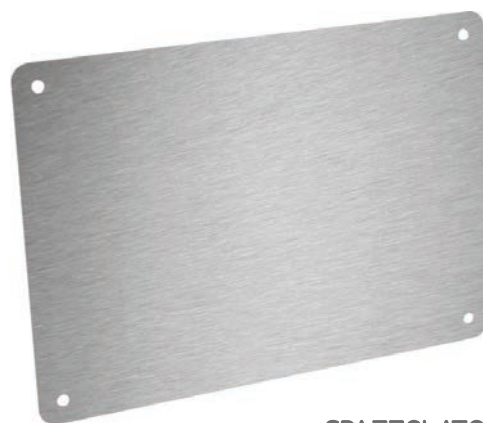

SPAZZOLATO

## SCHEDA TECNICA TARGHE PERSPEX DUO ARGENTO BRILLANTE MM.3

Codice Art.	Dimensioni cm.	L.P.
EUTAPXDA1020	20x10 con 2 fori	7
EUTAPXDA2015	20x15 con 4 fori	8
EUTAPXDA3020	30x20 con 4 fori	10
EUTAPXDA3525	35x25 con 4 fori	15
EUTAPXDA4030	40x30 con 4 fori	23
EUTAPXDA5025	50x25 con 4 fori	23
EUTAPXDA5035	50x35 con 4 fori	34
EUTAPXDA5050	50x50 con 4 fori	45
EUTAPXDA6040	60x40 con 4 fori	53
EUTAPXDA7050	70x50 con 4 fori	60

## SCHEDA TECNICA TARGHE EUROBOND SPECCHIO MM.3

Codice Art.	Dimensioni cm.	L.P.
EUTAEBSP1020	20x10 con 2 fori	7
EUTAEBSP2015	20x15 con 4 fori	8
EUTAEBSP3020	30x20 con 4 fori	10
EUTAEBSP3525	35x25 con 4 fori	15
EUTAEBSP4030	40x30 con 4 fori	23
EUTAEBSP5025	50x25 con 4 fori	23
EUTAEBSP5035	50x35 con 4 fori	34
EUTAEBSP5050	50x50 con 4 fori	45
EUTAEBSP6040	60x40 con 4 fori	53
EUTAEBSP7050	70x50 con 4 fori	60

## SCHEDA TECNICA TARGHE EUROBOND SPAZZOLATO MM.3

Codice Art.	Dimensioni cm.	L.P.
EUTAEBBF1020	20x10 con 2 fori	7
EUTAEBBF2015	20x15 con 4 fori	8
EUTAEBBF3020	30x20 con 4 fori	10
EUTAEBBF3525	35x25 con 4 fori	15
EUTAEBBF4030	40x30 con 4 fori	23
EUTAEBBF5025	50x25 con 4 fori	23
EUTAEBBF5035	50x35 con 4 fori	34
EUTAEBBF5050	50x50 con 4 fori	45
EUTAEBBF6040	60x40 con 4 fori	53
EUTAEBBF7050	70x50 con 4 fori	60



NERO SPAZZOLATO



SPECCHIO ANTRACITE

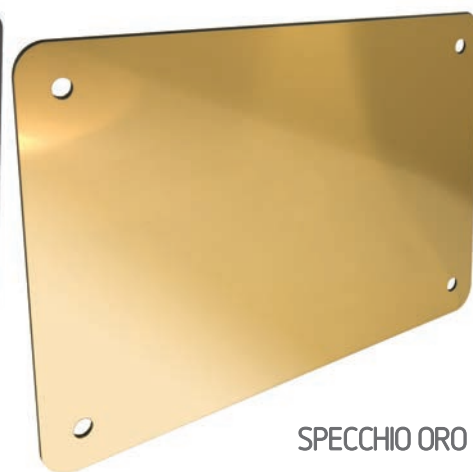

SPECCHIO ORO

## SCHEDA TECNICA TARGHE EUROBOND NERO SPAZZOLATO MM.3

Codice Art.	Dimensioni cm.	L.P.
EUTAEBBN2010	20x10 con 2 fori	7
EUTAEBBN2015	20x15 con 4 fori	8
EUTAEBBN3020	30x20 con 4 fori	10
EUTAEBBN3525	35x25 con 4 fori	15
EUTAEBBN4030	40x30 con 4 fori	23
EUTAEBBN5025	50x25 con 4 fori	23
EUTAEBBN5035	50x35 con 4 fori	34
EUTAEBBN5050	50x50 con 4 fori	45
EUTAEBBN6040	60x40 con 4 fori	53
EUTAEBBN7050	70x50 con 4 fori	60

## SCHEDA TECNICA TARGHE EUROBOND SPECCHIO ANTRACITE MM.3

Codice Art.	Dimensioni cm.	L.P.
EUTAEBSA1020	20x10 con 2 fori	7
EUTAEBSA2015	20x15 con 4 fori	8
EUTAEBSA3020	30x20 con 4 fori	10
EUTAEBSA3525	35x25 con 4 fori	15
EUTAEBSA4030	40x30 con 4 fori	23
EUTAEBSA5025	50x25 con 4 fori	23
EUTAEBSA5035	50x35 con 4 fori	34
EUTAEBSA5050	50x50 con 4 fori	45
EUTAEBSA6040	60x40 con 4 fori	53
EUTAEBSA7050	70x50 con 4 fori	60

## SCHEDA TECNICA TARGHE EUROBOND ORO SPECCHIO MM.3

Codice Art.	Dimensioni cm.	L.P.
EUTAEBOS1020	20x10 con 2 fori	7
EUTAEBOS2015	20x15 con 4 fori	8
EUTAEBOS3020	30x20 con 4 fori	10
EUTAEBOS3525	35x25 con 4 fori	15
EUTAEBOS4030	40x30 con 4 fori	23
EUTAEBOS5025	50x25 con 4 fori	23
EUTAEBOS5035	50x35 con 4 fori	34
EUTAEBOS5050	50x50 con 4 fori	45
EUTAEBOS6040	60x40 con 4 fori	53
EUTAEBOS7050	70x50 con 4 fori	60

ALTRE MISURE SU RICHIESTA



## TARGHE CLASSICHE TRASPARENTI SPESS. 3 MM.

Codice Art.	Descrizione	L.P.
EUTAPX31020	Classica leggera cm.10x20 con 2 fori	5
EUTAPX31520	Classica leggera cm.15x20 con 4 fori	6
EUTAPX33020	Classica leggera cm.30x20 con 4 fori	7
EUTAPX33525	Classica leggera cm.35x25 con 4 fori	11
EUTAPX34030	Classica leggera cm.40x30 con 4 fori	14
EUTAPX35035	Classica leggera cm.50x35 con 4 fori	22
EUTAPX36040	Classica leggera cm.60x40 con 4 fori	28
EUTAPX35050	Classica leggera cm.50x50 con 4 fori	30
EUTAPX37050	Classica leggera cm.70x50 con 4 fori	45

## TARGHE CLASSICHE TRASPARENTI SPESS. 5 MM.

Codice Art.	Descrizione	L.P.
EUTAPX51020	Classica cm.10x20 con 2 fori	7
EUTAPX51520	Classica cm.15x20 con 4 fori	8
EUTAPX53020	Classica cm.30x20 con 4 fori	10
EUTAPX53525	Classica cm.35x25 con 4 fori	15
EUTAPX54030	Classica cm.40x30 con 4 fori	20
EUTAPX55035	Classica cm.50x35 con 4 fori	30
EUTAPX56040	Classica cm.60x40 con 4 fori	40
EUTAPX55050	Classica cm.50x50 con 4 fori	42
EUTAPX57050	Classica cm.70x50 con 4 fori	60



## TARGHE CLASSICHE TRASPARENTI SPESS. 8 MM.

Codice Art.	Descrizione	L.P.
EUTAPX81020	Targa classica cm.10x20 con 2 fori	9
EUTAPX81520	Targa classica cm.15x20 con 4 fori	10
EUTAPX83020	Targa classica cm.30x20 con 4 fori	13
EUTAPX83525	Targa classica cm.35x25 con 4 fori	20
EUTAPX84030	Targa classica cm.40x30 con 4 fori	30
EUTAPX85025	Targa classica cm.50x25 con 4 fori	30
EUTAPX85035	Targa classica cm.50x35 con 4 fori	45
EUTAPX85050	Targa classica cm.50x50 con 4 fori	60
EUTAPX86040	Targa classica cm.60x40 con 4 fori	70
EUTAPX87050	Targa classica cm.70x50 con 4 fori	80
EUTAPX810050	Targa classica cm.100x50 con 4 fori	110
EUTAPX815050	Targa classica cm.150x50 con 6 fori	130
EUTAPX820050	Targa classica cm.200x50 con 6 fori	175
EUTAPX830050	Targa classica cm.300x50 con 8 fori	250
EUTAPX810070	Targa classica cm.100x70 con 4 fori	135
EUTAPX815070	Targa classica cm.150x70 con 6 fori	190
EUTAPX820070	Targa classica cm.200x70 con 6 fori	250
EUTAPX830066	Targa classica cm.300x66 con 8 fori	350
EUTAPX8100100	Targa classica cm.100x100 con 4 fori	175
EUTAPX8150100	Targa classica cm.150x100 con 6 fori	250
EUTAPX8200100	Targa classica cm.200x100 con 6 fori	350
EUTAPX8300100	Targa classica cm.300x100 con 8 fori	525

## TARGHE CLASSICHE TRASPARENTI SPESS. 12 MM.

Codice Art.	Descrizione	L.P.
EUTAPX121020	Targa classica cm.10x20 con 2 fori	14
EUTAPX121520	Targa classica cm.15x20 con 4 fori	16
EUTAPX123020	Targa classica cm.30x20 con 4 fori	20
EUTAPX123525	Targa classica cm.35x25 con 4 fori	30
EUTAPX124030	Targa classica cm.40x30 con 4 fori	45
EUTAPX125025	Targa classica cm.50x25 con 4 fori	45
EUTAPX125035	Targa classica cm.50x35 con 4 fori	67
EUTAPX125050	Targa classica cm.50x50 con 4 fori	90
EUTAPX126040	Targa classica cm.60x40 con 4 fori	105
EUTAPX127050	Targa classica cm.70x50 con 4 fori	120
EUTAPX1210050	Targa classica cm.100x50 con 4 fori	165
EUTAPX1215050	Targa classica cm.150x50 con 6 fori	195
EUTAPX1220050	Targa classica cm.200x50 con 6 fori	260
EUTAPX1230050	Targa classica cm.300x50 con 8 fori	375
EUTAPX1210070	Targa classica cm.100x70 con 4 fori	200
EUTAPX1215070	Targa classica cm.150x70 con 6 fori	285
EUTAPX1220070	Targa classica cm.200x70 con 6 fori	375
EUTAPX1230066	Targa classica cm.300x66 con 8 fori	525
EUTAPX12100100	Targa classica cm.100x100 con 4 fori	260
EUTAPX12150100	Targa classica cm.150x100 con 6 fori	375
EUTAPX12200100	Targa classica cm.200x100 con 6 fori	525
EUTAPX12300100	Targa classica cm.300x100 con 8 fori	780

# TUTTOTARGHE

Targhe in Perspex colato trasparente, sia da interno che da esterno, disponibili in varie forme e dimensioni negli spessori da mm. 3/5/8/12/15. Fori per il fissaggio a muro già praticati, distanziali acquistabili a parte in diverse finiture.

*Perspex plates cast transparent, both indoor and outdoor, available in various shapes and sizes in thicknesses from mm. 3/5/8/12/15. Anchor holes already drilled in the wall, spacers sold separately in different finishes.*

## TARGHE CLASSICHE TRASPARENTI SPESS. 15 MM.

Codice Art.	Descrizione	L.P.
EUTAPX151020	Classica spess. 15mm cm.10x20 con 2 fori	18
EUTAPX151520	Classica spess. 15mm cm.15x20 con 4 fori	20
EUTAPX153020	Classica spess. 15mm cm.30x20 con 4 fori	26
EUTAPX153525	Classica spess. 15mm cm.35x25 con 4 fori	40
EUTAPX154030	Classica spess. 15mm cm.40x30 con 4 fori	60
EUTAPX155025	Classica spess. 15mm cm.50x25 con 4 fori	60
EUTAPX155035	Classica spess. 15mm cm.50x35 con 4 fori	90
EUTAPX155050	Classica spess. 15mm cm.50x50 con 4 fori	120
EUTAPX156040	Classica spess. 15mm cm.60x40 con 4 fori	140
EUTAPX157050	Classica spess. 15mm cm.70x50 con 4 fori	160
EUTAPX1570100	Classica spess. 15mm cm.70x100 con 4 fori	270

## TARGHE ELLY LEGGERE TRASPARENTI SPESS. 3 MM.

Codice Art.	Descrizione	L.P.
EUTAPXEL33017	Targa Elly leggera cm.30x17	7
EUTAPXEL33520	Targa Elly leggera cm.35x20	11
EUTAPXEL34023	Targa Elly leggera cm.40x23	14
EUTAPXEL35029	Targa Elly leggera cm.50x29	22

## TARGHE ELLY LEGGERE TRASPARENTI SPESS. 5 MM.

Codice Art.	Descrizione	L.P.
EUTAPXEL53017	Targa Elly leggera cm.30x17	10
EUTAPXEL53520	Targa Elly leggera cm.35x20	15
EUTAPXEL54023	Targa Elly leggera cm.40x23	20
EUTAPXEL55029	Targa Elly leggera cm.50x29	30
EUTAPXEL56035	Targa Elly leggera cm.60x35	40
EUTAPXEL57544	Targa Elly leggera cm.75x44	60

## TARGHE ELLY LEGGERE TRASPARENTI SPESS. 8 MM.

Codice Art.	Descrizione	L.P.
EUTAPXEL83017	Targa Elly alto spessore cm.30x17	13
EUTAPXEL83520	Targa Elly alto spessore cm.35x20	20
EUTAPXEL84023	Targa Elly alto spessore cm.40x23	26
EUTAPXEL85029	Targa Elly alto spessore cm.50x29	40
EUTAPXEL86035	Targa Elly alto spessore cm.60x35	54
EUTAPXEL87544	Targa Elly alto spessore cm.75x44	80
EUTAPXEL810058	Targa Elly alto spessore cm.100x58	135
EUTAPXEL815088	Targa Elly alto spessore cm.150x88	250

## TARGHE INTERCAMBIABILI SPESS. 3 MM.

Codice Art.	Descrizione	L.P.
EUTAPXITA5	Targa intercambiabile f.to A5	13
EUTAPXITA5HO	Targa intercambiabile f.to A5 orizzontale	13
EUTAPXITA4	Targa intercambiabile f.to A4	20
EUTAPXITA4HO	Targa intercambiabile f.to A4 orizzontale	20
EUTAPXITA3	Targa intercambiabile f.to A3	38
EUTAPXITA3HO	Targa intercambiabile f.to A3 orizzontale	38
EUTAPXITA2	Targa intercambiabile f.to A2	85
EUTAPXITA2HO	Targa intercambiabile f.to A2 orizzontale	85
EUTAPXITA1	Targa intercambiabile f.to A1	140
EUTAPXITA1HO	Targa intercambiabile f.to A1 orizzontale	140
EUTAPXITB2	Targa intercambiabile f.to B2 (cm 50x70)	110
EUTAPXITB2HO	Targa intercambiabile f.to B2 orizzontale (cm 70x50)	110
EUTAPXITB1	Targa intercambiabile f.to B1 (cm 70x100)	155
EUTAPXITB1HO	Targa intercambiabile f.to B1 orizzontale (cm 100x70)	155



# DISTANZIALI

## COPRIVITE MM. 10/12/15/19/25 X 6

Codice Art.	Descrizione	Dimensioni mm			L.P. Cad.
		A	B	C	
UFCA106CRO	Coprivite cromo lucido mm.10x6	10	0	0	1,80
UFCA106ORO	Coprivite oro lucido mm.10x6	10	0	0	1,80
UFCA106SAT	Coprivite argento satinato mm.10x6	10	0	0	1,80
UFCA126CRO	Coprivite cromo lucido mm.12x6	12	0	0	2,00
UFCA126ORO	Coprivite oro lucido mm.12x6	12	0	0	2,00
UFCA126SAT	Coprivite argento satinato mm.12x6	12	0	0	2,00
UFCA156CRO	Coprivite cromo lucido mm.15x6	15	0	0	2,30
UFCA156ORO	Coprivite oro lucido mm.15x6	15	0	0	2,30
UFCA156SAT	Coprivite argento satinato mm.15x6	15	0	0	2,30
UFCA196CRO	Coprivite cromo lucido mm.19x6	19	0	0	2,70
UFCA196ORO	Coprivite oro lucido mm.19x6	19	0	0	2,70
UFCA196SAT	Coprivite argento satinato mm.19x6	19	0	0	2,70
UFCA256CRO	Coprivite cromo lucido mm.25x6	25	0	0	3,20
UFCA256ORO	Coprivite oro lucido mm. 25x6	25	0	0	3,20
UFCA256SAT	Coprivite argento satinato mm. 25x6	25	0	0	3,20

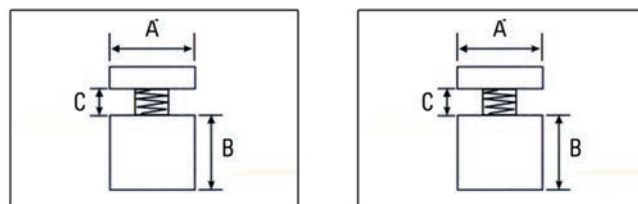
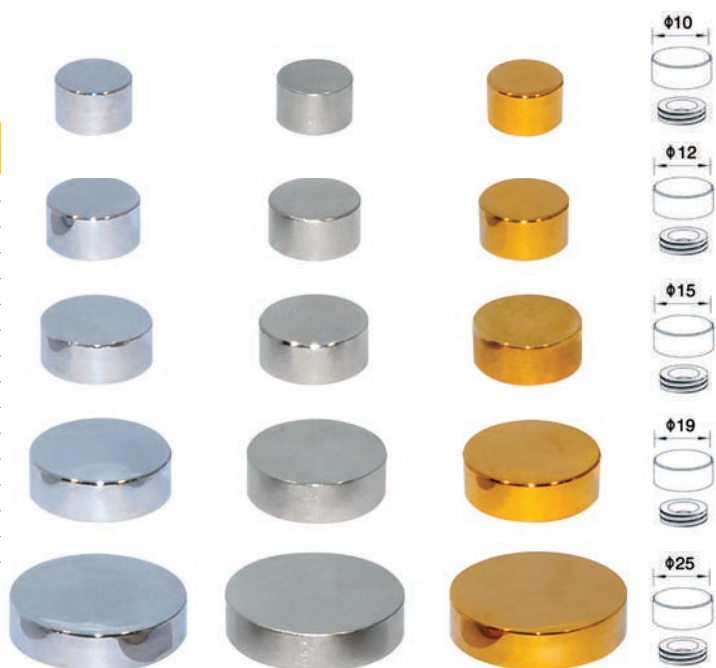

## DISTANZIALI PER TARGHE SPES. MAX MM. 5

Codice Articolo	Descrizione	Dimensioni mm			L.P./Cad
		A	B	C	
UFCA1313CRO	Distanziale cromo lucido mm. 13x13	13	13	5	2,30
UFCA1313ORO	Distanziale oro antico. mm. 13x13	13	13	5	2,30
UFCA1313OCR	Distanziale oro cromo mm. 13x13	13	13	5	2,30
UFCA1313SAT	Distanziale argento satinato mm. 13x13	13	13	5	2,30
UFCA1313ROS	Distanziale rosso satinato mm. 13x13	13	13	5	2,30
UFCA1313BLU	Distanziale blu satinato mm. 13x13	13	13	5	2,30
UFCA1313NE	Distanziale nero satinato mm. 13x13	13	13	5	2,30



## DISTANZIALI PER TARGHE SPES. MAX MM. 10

Codice Articolo	Descrizione	Dimensioni mm			L.P./Cad
		A	B	C	
UFCA1319CRO	Distanziale cromo lucido mm. 13x19	13	19	10	2.60
UFCA1319ORO	Distanziale oro antico mm. 13x19	13	19	10	2.60
UFCA1319OCR	Distanziale oro cromo mm. 13x19	13	19	10	2.60
UFCA1319SAT	Distanziale argento satinato mm. 13x19	13	19	10	2.60
UFCA1319ROS	Distanziale rosso satinato mm. 13x19	13	19	10	2.60
UFCA1319BLU	Distanziale blu satinato mm. 13x19	13	19	10	2.60
UFCA1319NE	Distanziale nero satinato mm. 13x19	13	19	10	2.60



## DISTANZIALI PER TARGHE SPES. MAX MM. 10

Codice Articolo	Descrizione	Dimensioni mm			L.P./Cad
		A	B	C	
UFCA1520CRO	Distanziale cromo lucido mm. 15x20	15	20	10	3.60
UFCA1520OCR	Distanziale oro cromo mm. 15x20	15	20	10	3.30
UFCA1520SAT	Distanziale argento satinato mm. 15x20	15	20	10	3.30
UFCA1520ROS	Distanziale rosso satinato mm. 15x20	15	20	10	3.30
UFCA1520BLU	Distanziale blu satinato mm. 15x20	15	20	10	3.30
UFCA1520NE	Distanziale nero satinato mm. 15x20	15	20	10	3.30



### DISTANZIALI PER TARGHE SPESS. MAX MM. 15

Codice Articolo	Descrizione	Dimensioni mm			L.P./Cad
		A	B	C	
UFCA1525CRO	Distanziale cromo lucido mm. 15x25	15	25	15	4.00
UFCA1525OCR	Distanziale oro cromo mm. 15x25	15	25	15	3.60
UFCA1525SAT	Distanziale argento satinato mm. 15x25	15	25	15	3.60
UFCA1525ROS	Distanziale rosso satinato mm. 15x25	15	25	15	3.60
UFCA1525BLU	Distanziale blu satinato mm. 15x25	15	25	15	3.60
UFCA1525NE	Distanziale nero satinato mm. 15x25	15	25	15	3.60



### DISTANZIALI PER TARGHE SPESS. MAX MM. 15

Codice Articolo	Descrizione	Dimensioni mm			L.P./Cad
		A	B	C	
UFCA1925CRO	Distanziale cromo lucido mm. 19x25	19	25	15	4.50
UFCA1925ORO	Distanziale oro antico mm. 19x25	19	25	15	4.50
UFCA1925OCR	Distanziale oro cromo mm. 19x25	19	25	15	4.10
UFCA1925SAT	Distanziale argento satinato mm. 19x25	19	25	15	4.10
UFCA1925ROS	Distanziale rosso satinato mm. 19x25	19	25	15	4.10
UFCA1925BLU	Distanziale blu satinato mm. 19x25	19	25	15	4.10
UFCA1925NE	Distanziale nero satinato mm. 19x25	19	25	15	4.10



### DISTANZIALI PER TARGHE SPESS. MAX MM. 20

Codice Articolo	Descrizione	Dimensioni mm			L.P./Cad
		A	B	C	
UFCA2530CRO	Distanziale cromo lucido mm. 25x30	25	30	20	5.30
UFCA2530ORO	Distanziale oro antico mm. 25x30	25	30	20	5.30
UFCA2530OCR	Distanziale oro cromo mm. 25x30	25	30	20	5.30
UFCA2530SAT	Distanziale argento satinato mm. 25x30	25	30	20	5.30
UFCA2530NE	Distanziale nero satinato mm. 25x30	25	30	20	5.30



### DISTANZIALI PER TARGHE SPESS. MAX MM. 25

Codice Art.	Descrizione	Dimensioni mm			L.P./Cad
		A	B	C	
UFNCN2550CRO	Distanziale cromo lucido dim. mm. 25x50	25	50	25	20,90
UFNCN2550ORO	Distanziale oro satinato dim. mm. 25x50	25	50	25	24,48
UFNCN2550SAT	Distanziale argento satinato mm. 25x50	25	50	25	22,70

### DISTANZIALI PER TARGHE SPESS. MAX MM. 25

Codice Art.	Descrizione	Dimensioni mm			L.P./Cad
		A	B	C	
UFNCN2575CRO	Distanziale cromo lucido dim. mm. 25x75	25	75	25	25,92
UFNCN2575ORO	Distanziale oro satinato dim. mm. 25x75	25	75	25	29,52
UFNCN2575SAT	Distanziale argento satinato mm. 25x75	25	75	25	27,75



# DISTANZIALI

## SCHEMA TECNICA

Codice Art.	Descrizione	Dimensioni mm			L.P./Cad
		A	B	C	
UFSA1616ST	Distanz. argento satinato mm. 16x16	16	16	8	4,56
UFSA1616CP	Distanz. cromo lucido dim. mm. 16x16	16	16	8	4,80

## SCHEMA TECNICA

Codice Art.	Descrizione	Dimensioni mm			L.P./Cad
		A	B	C	
UFSA1625ST	Distanz. argento satinato mm. 16x25	16	25	12	5,04
UFSA1625CP	Distanz. cromo lucido dim. mm. 16x25	16	25	12	5,28

## SCHEMA TECNICA

Codice Art.	Descrizione	Dimensioni mm			L.P./Cad
		A	B	C	
UFSA1640ST	Distanz. argento satinato mm. 16x40	16	40	20	5,76
UFSA1640CP	Distanz. cromo lucido dim. mm. 16x40	16	40	20	6,00



## SCHEMA TECNICA

Codice Art.	Descrizione	Dimensioni mm			L.P./Cad
		A	B	C	
UFSA1925ST	Distanz. argento satinato mm. 19x25	19	25	12	5,15
UFSA1925CP	Distanz. cromo lucido mm. 19x25	19	25	12	5,60

## SCHEMA TECNICA

Codice Art.	Descrizione	Dimensioni mm			L.P./Cad
		A	B	C	
UFSA2525ST	Distanz. argento satinato mm. 25x25	25	25	12	7,68
UFSA2525CP	Distanz. cromo lucido dim. mm. 25x25	25	25	12	8,28

## SCHEMA TECNICA

Codice Art.	Descrizione	Dimensioni mm			L.P./Cad
		A	B	C	
UFSA2540ST	Distanz. argento satinato mm. 25x40	25	40	20	9,85
UFSA2540CP	Distanz. cromo lucido dim. mm. 25x40	25	40	20	10,44

## SCHEMA TECNICA

Codice Art.	Descrizione	Dimensioni mm			L.P./Cad
		A	B	C	
UFSA2551ST	Distanz. argento satinato mm. 25x51	25	51	25	11,16
UFSA2551CP	Distanz. cromo lucido dim. mm. 25x51	25	51	25	11,76



## SCHEMA TECNICA

Codice Art.	Descrizione	Dimensioni mm			L.P./Cad
		A	B	C	
UFSA3225ST	Distanz. argento satinato mm. 32x25	32	25	12	9,66
UFSA3225CP	Distanz. cromo lucido dim. mm. 32x25	32	25	12	10,08

## SCHEMA TECNICA

Codice Art.	Descrizione	Dimensioni mm			L.P./Cad
		A	B	C	
UFSA3240ST	Distanz. argento satinato mm. 32x40	32	40	20	11,16
UFSA3240CP	Distanz. cromo lucido dim. mm. 32x40	32	40	20	11,76

## SCHEMA TECNICA

Codice Art.	Descrizione	Dimensioni mm			L.P./Cad
		A	B	C	
UFSA3251ST	Distanz. argento satinato mm. 32x51	32	51	25	12,60
UFSA3251CP	Distanz. cromo lucido dim. mm. 32x51	32	51	25	13,20





### SCHEDA TECNICA

Codice Art.	Descrizione	Dim.mm			L.P./Cad
		A	B	C	
UFGR1614CP	Distanz. cromo lucido mm. 16x14	16	14	8	3,90
UFGR1614SS	Distanz. argento satin mm. 16x14	16	14	8	4,20

### SCHEDA TECNICA

Codice Art.	Descrizione	Dim.mm			L.P./Cad
		A	B	C	
UFGR1625CP	Distanz. cromo lucido mm. 16x25	16	25	15	5,60
UFGR1625SS	Distanz. argento satin mm. 16x25	16	25	15	5,90

### SCHEDA TECNICA

Codice Art.	Descrizione	Dim.mm			L.P./Cad
		A	B	C	
UFGR2525CP	Distanz. cromo lucido mm. 25x25	25	25	20	12,75
UFGR2525SS	Distanz. argento satin mm. 25x25	25	25	20	13,25

### SCHEDA TECNICA

Codice Art.	Descrizione	Dim.mm			L.P./Cad
		A	B	C	
UFGR2550CP	Distanz. cromo lucido mm. 25x50	25	50	25	19,00
UFGR2550SS	Distanz. argento satin mm. 25x50	25	50	25	19,50



### SCHEDA TECNICA

Codice Art.	Descrizione	Dim.mm			L.P./Cad
		A	B	C	
UFCH1623CP	Distanz. cromo lucido mm. 16x23	16	23	15	6,25
UFCH1623BG	Distanz. oro lucido mm. 16x23	16	23	15	6,75
UFCH1623SS	Distanz. argento satin mm. 16x23	16	23	15	6,60

### SCHEDA TECNICA

Codice Art.	Descrizione	Dim.mm			L.P./Cad
		A	B	C	
UFCH2327CP	Distanz. cromo lucido mm. 23x27	23	27	20	8,60
UFCH2327BG	Distanz. oro lucido mm. 23x27	23	27	20	9,10
UFCH2327SS	Distanz. argento satin mm. 23x27	23	27	20	9,00



## DISTANZIALI PER TARGHE SERIE ACCIAIO

### SCHEDA TECNICA

Codice Articolo	Descrizione	Dimensioni mm			L.P./Cad
		A	B	C	
UFSS1319	Distanz. acciaio mm. 13x19	13	19	5	4,50
UFSS1925	Distanz. acciaio mm. 19x25	19	25	6	7,50
UFSS2525	Distanz. acciaio mm. 25x25	25	25	10	12,50

### SCHEDA TECNICA

Codice Articolo	Descrizione	Dimensioni mm			L.P./Cad
		A	B	C	
UFSS1320	Distanz. acciaio mm. 13x20	13	20	5	4,80
UFSS1820	Distanz. acciaio mm. 18x20	18	20	8/10	7,20



# DISTANZIALI IN PLASTICA TRASPARENTE

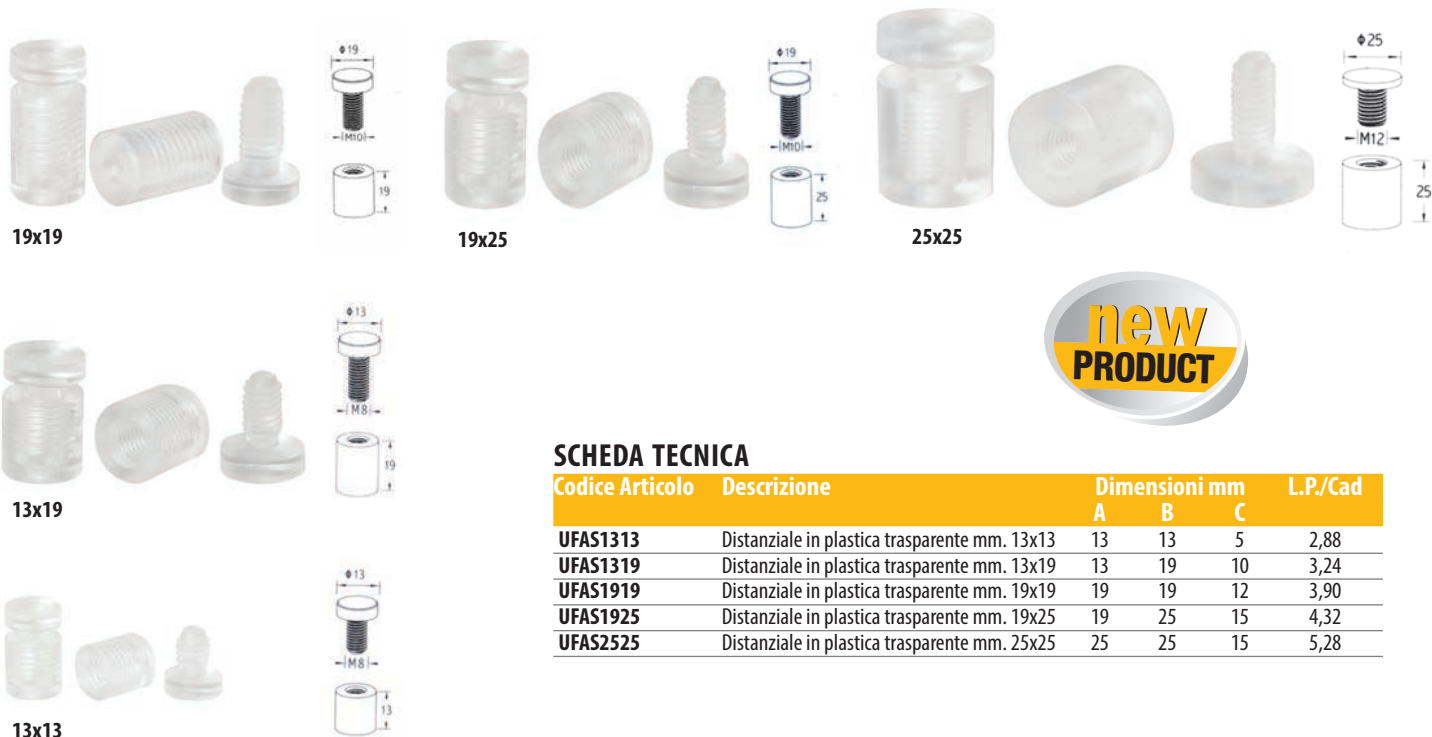

## SCHEDA TECNICA

Codice Articolo	Descrizione	Dimensioni mm			L.P./Cad
		A	B	C	
UFAS1313	Distanziale in plastica trasparente mm. 13x13	13	13	5	2,88
UFAS1319	Distanziale in plastica trasparente mm. 13x19	13	19	10	3,24
UFAS1919	Distanziale in plastica trasparente mm. 19x19	19	19	12	3,90
UFAS1925	Distanziale in plastica trasparente mm. 19x25	19	25	15	4,32
UFAS2525	Distanziale in plastica trasparente mm. 25x25	25	25	15	5,28

# DISTANZIALI IN ALLUMINIO

## DISTANZIALI PERIMETRALI



UFPE1619 - EUPE1925

UFPE2537 - EUPE3037

## SCHEDA TECNICA

Codice Articolo	Descrizione	Dimensioni mm			L.P./Cad
		A	B	C	
UFPE1619	Distanz. perimetro dim. mm. 16x19	16	19	6	4,80
UFPE1925	Distanz. perimetro dim. mm. 19x25	19	25	9	7,00
UFPE2537	Distanz. perimetro dim. mm. 25x37	25	37	8	7,80
UFPE3037	Distanz. perimetro dim. mm. 30x37	30	37	8	8,10

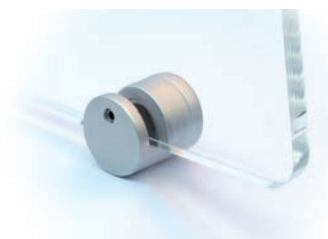

## SUPPORTI DA TAVOLO

### SCHEDA TECNICA

Codice Art.	Descrizione	Spess. targa mm.	L.P./Cad
UFTS0871SS	Supporto da tavolo argento satinato mm 8x71	5/6	4,50
UFTS0871CP	Supporto da tavolo cromo lucido mm 8x71	5/6	4,50



### SCHEDA TECNICA

Codice Art.	Descrizione	Spess. targa mm.	L.P./Cad
UFTS1025	Supporto da tavolo in acciaio mm 10x25	5/6	3,80

# STAFFA TARGHE A PARETE E BANDIERA

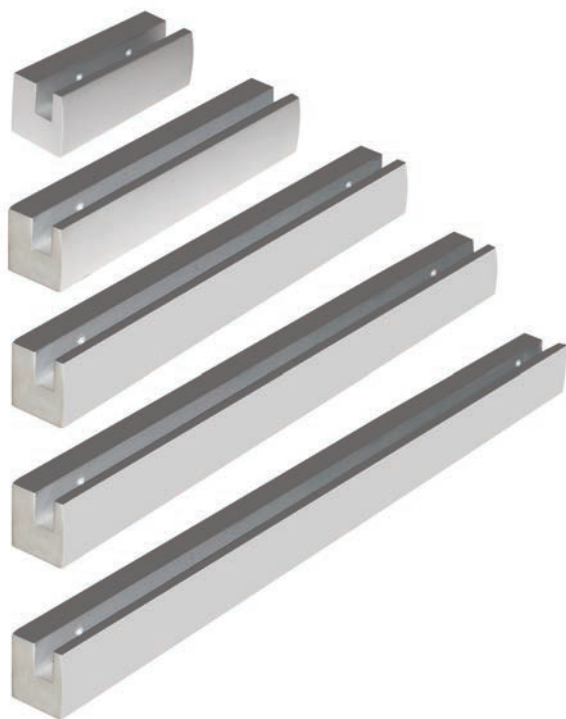

## SCHEDA TECNICA

Codice Articolo	Descrizione	Spess. max targa mm.	L.P.
UFXC1580	Staffa in all. argento sat. mm. 80	8	19,20
UFXC15120	Staffa in all. argento sat. mm. 120	8	21,60
UFXC15180	Staffa in all. argento sat. mm. 180	8	28,80
UFXC15280	Staffa in all. argento sat. mm. 280	8	36,00
UFXC15380	Staffa in all. argento sat. mm. 380	8	50,40



## SCHEDA TECNICA STAFFA A BANDIERA

Codice Articolo	Descrizione	Spess. max targa mm.	L.P.
UFXC1580FLAG	Alluminio argento sat. mm. 80	8	19,20
UFXC15120FLAG	Alluminio argento sat. mm. 120	8	21,60

# PORTATARGA **LED**

Kit per il fissaggio di targhe in Perspex tramite staffa alluminio con LED bianco freddo; inclusa la multiporta e l'alimentatore da 12v.

*Kit for fixing plates Perspex using aluminum bracket with LED cool white; including the multiport and power supply to 12v.*

**LED TECHNOLOGY**

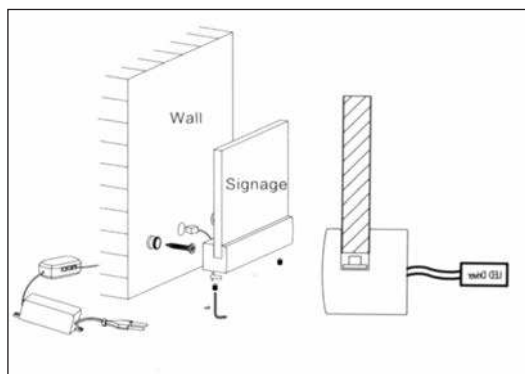

## SCHEDA TECNICA

Codice Art.	Descrizione	Spessore max targa	L.P.
UFXC80LEDB	Staffa alluminio a LED bianchi mm 80 + alimentatore	8 mm	55
UFXC180LEDB	Staffa alluminio a LED bianchi mm 180 + alimentatore	8 mm	70
UFXC280LEDB	Staffa alluminio a LED bianchi mm 280 + alimentatore	8 mm	90
UFXC380LEDB	Staffa alluminio a LED bianchi mm 380 + alimentatore	8 mm	120

# US STANDING

Struttura autoportante realizzata in alluminio anodizzato silver. Questo espositore consente di esporre più messaggi grazie a delle tasche realizzate in Perspex trasparente, sorrette da un sistema di cavi in acciaio tensionati. Le tasche, in formato A4, possono essere doppie o triple e la composizione, all'interno della struttura, potrà essere a piacimento. Di seguito riportiamo alcune dimensioni standard, a richiesta, è possibile realizzare altre dimensioni e composizioni.

*Self-standing structure realized with silver anodized aluminum. This exhibitor allows to show several messages thanks to the clear Perspex pockets, hold through a system of steel stretched wires. Pockets, size A4, can be double or triple and the composition inside the structure can be to pleasure. In the following pictures there are some standard sizes and, upon request, it is possible to realize other sizes and compositions.*



## COMPOSIZIONE STRUTTURE

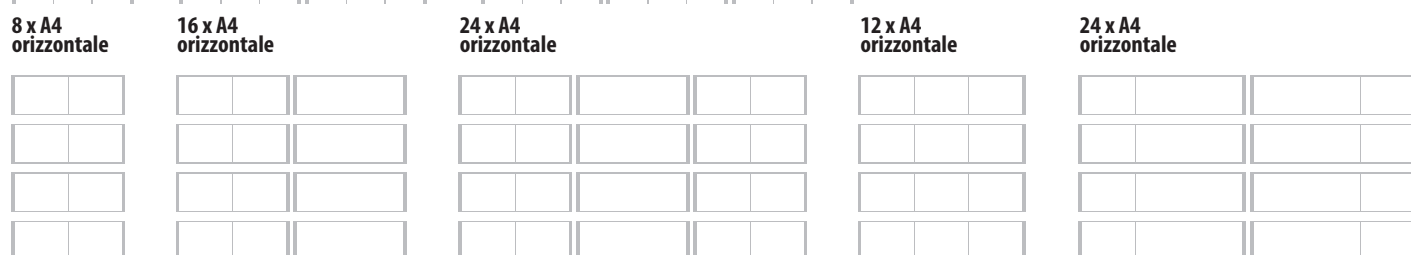
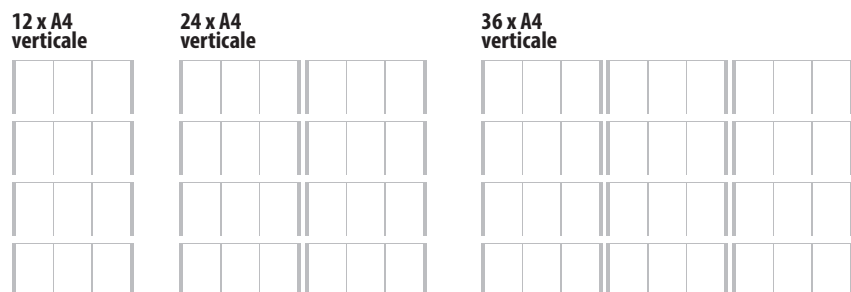
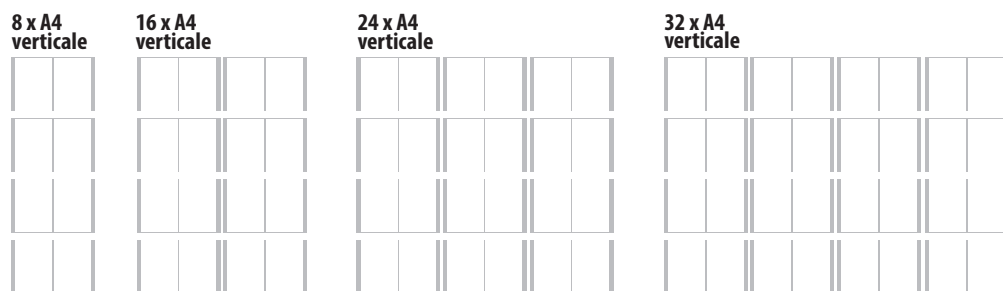

### SCHEDA TECNICA A4 VERTICALI

Codice art.	Dim. struttura cm.	F.to tasche	N. pannelli	Tip. Tasche	N. tasche A4	L.P.
EUUSSTA42A4V	60x200	A4 verticale	4	2 x A4	8	336
EUUSSTA82A4V	113x200	A4 verticale	8	2 x A4	16	550
EUUSSTA122A4V	166x200	A4 verticale	12	2 x A4	24	744
EUUSSTA162A4V	219x200	A4 verticale	16	2 x A4	32	862
EUUSSTA43A4V	83x200	A4 verticale	4	3 x A4	12	424
EUUSSTA83A4V	159x200	A4 verticale	8	3 x A4	24	686
EUUSSTA123A4V	235x200	A4 verticale	12	3 x A4	36	948

### SCHEDA TECNICA A4 ORIZZONTALI

Codice art.	Dim. struttura cm.	F.to tasche	N. pannelli	Tip. Tasche	N. tasche A4	L.P.
EUUSSTA42A4O	78x200	A4 orizzontale	4	2 x A4	8	350
EUUSSTA82A4O	149x200	A4 orizzontale	8	2 x A4	16	520
EUUSSTA122A4O	220x200	A4 orizzontale	12	2 x A4	24	678
EUUSSTA43A4O	110x200	A4 orizzontale	4	3 x A4	12	406
EUUSSTA83A4O	213x200	A4 orizzontale	8	3 x A4	24	620

### KIT ARGENTO SATINATO



# SISTEMI DI FISSAGGIO A SOSPENSIONE

Serie di fissaggi per targhe a sospensione. Il kit comprende i fissaggi a soffitto, il cavo in acciaio e le pinze per i pannelli.  
Disponibili in argento satinato e cromo lucido.

*Suspension fixing system for plates. Kit includes ceiling fixing, steel wire and tongs for panels.  
Available in frost argent and gloss chrome.*



## SERIE CROMO

Codice art.	Descrizione	L.P.
UFCF901CR	Fissaggio a soffitto	5,40
UFCF902CR	Fissaggio al pannello	7,20
FVCAV015	Cavo acciaio Ø mm 1,5 mt/l	1,20

## SERIE SILVER

Codice art.	Descrizione	L.P.
UFCF901AS	Fissaggio a soffitto	6,00
UFCF902AS	Fissaggio al pannello	7,80
FVCAV015	Cavo acciaio Ø mm 1,5 mt/l	1,20

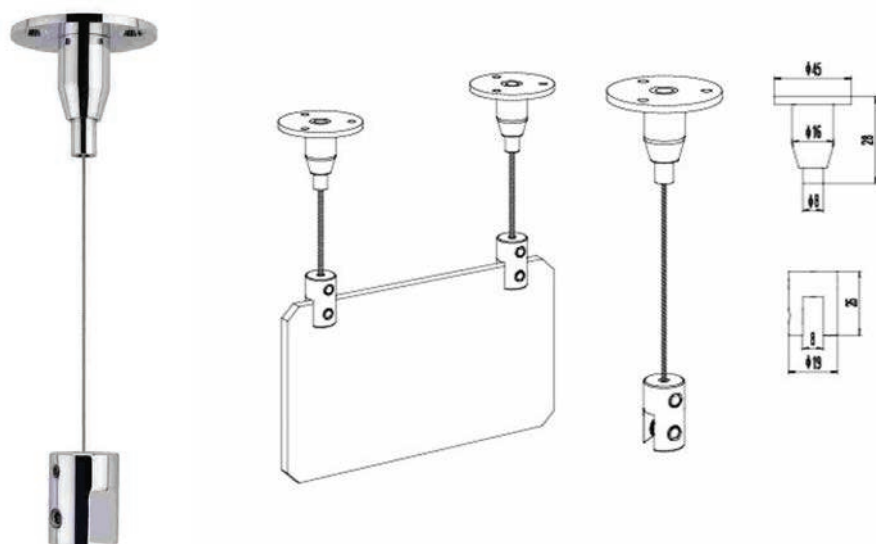
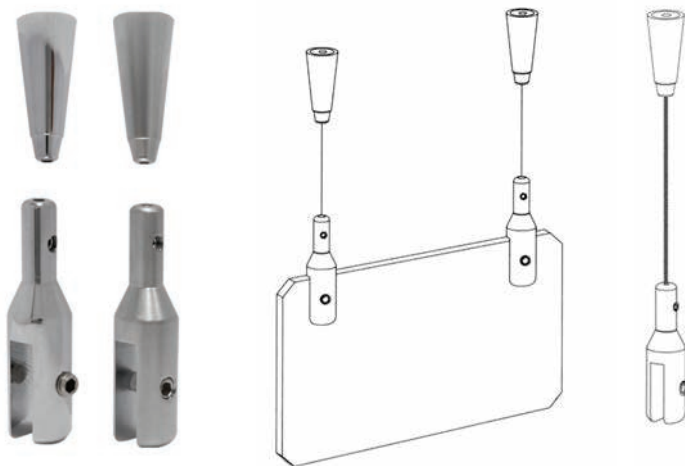

## SERIE CROMO

Codice art.	Descrizione	L.P.
UFCF101CP	Fissaggio a soffitto	6,60
UFCF102CP	Fissaggio al pannello	6,60
FVCAV015	Cavo acciaio Ø mm. 1,5 x 1mtl	1,20

## SERIE SILVER

Codice art.	Descrizione	L.P.
UFCF101SS	Fissaggio a soffitto	7,35
UFCF102SS	Fissaggio al pannello	7,35
FVCAV015	Cavo acciaio Ø mm. 1,5 x 1mtl	1,20

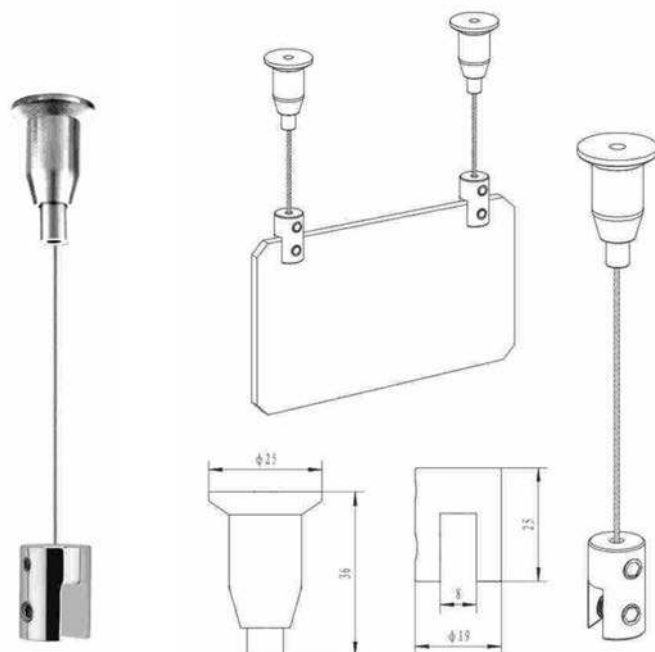

## SERIE CROMO

Codice art.	Descrizione	L.P.
UFCF1B01CP	Fissaggio a soffitto	6
UFCF1B02CP	Fissaggio al pannello	6
FVCAV015	Cavo acciaio Ø mm. 1,5 x 1mtl	1,20

## SERIE SILVER

Codice art.	Descrizione	L.P.
UFCF1B01SS	Fissaggio a soffitto	6,50
UFCF1B02SS	Fissaggio al pannello	6,50
FVCAV015	Cavo acciaio Ø mm. 1,5 x 1mtl	1,20

# SISTEMI DI FISSAGGIO CON TIRANTI

## SILVER E CHROME

Kit composto da coppia di tiranti snodati, pinze laterali e doppie e cavo in acciaio per il sostegno di poster acrilici a muro. Disponibili con finitura cromo lucido o argento satinato.

Kit consisting of a pair of tie rods articulated, lateral and double grippers and steel cable for the support of acrylic Poster wall. Available in polished chrome or satin silver.

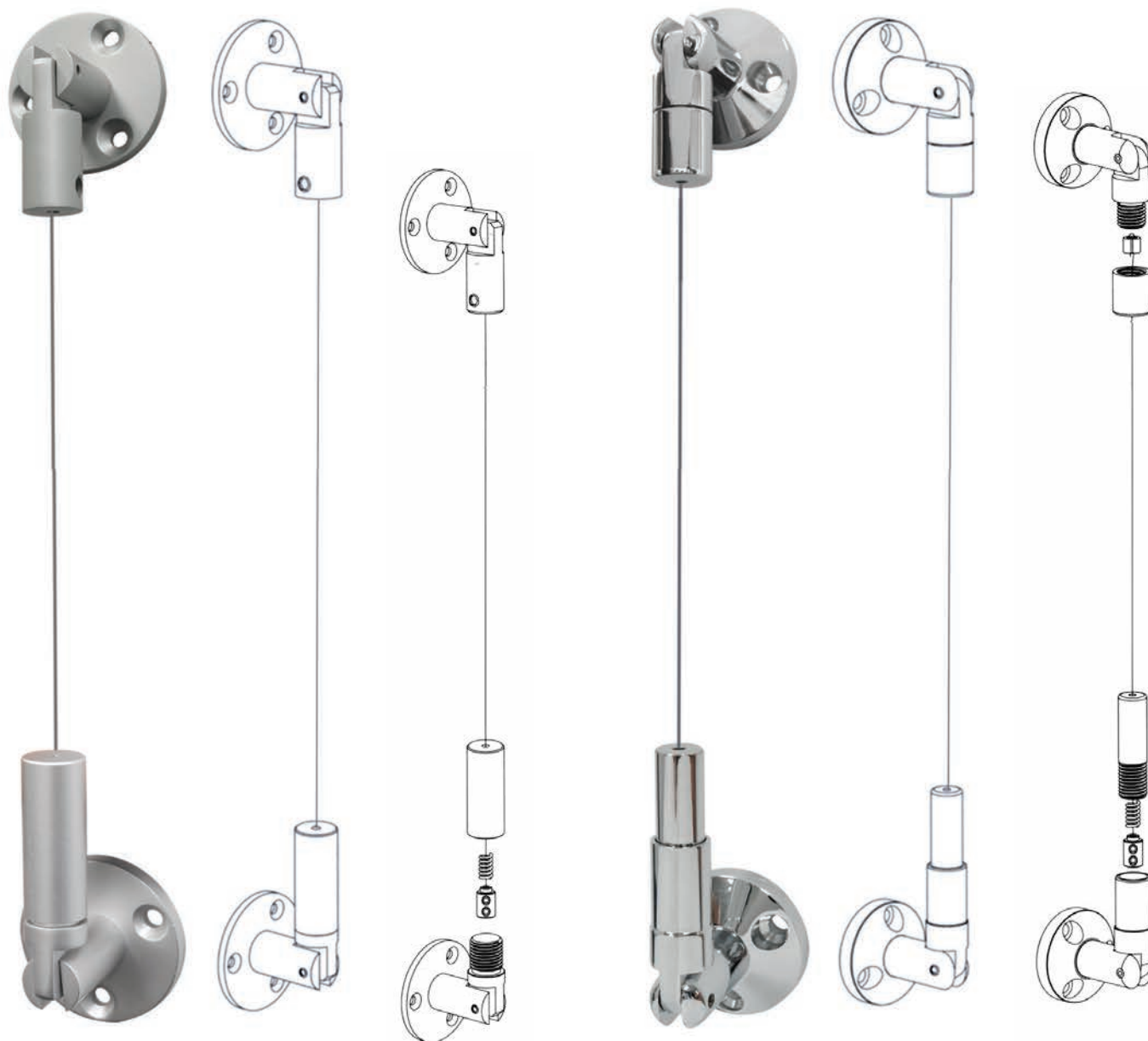

### SCHEDA TECNICA

Codice art.	Descrizione	L.P.
UFCF41AS	Tirante snodato fisso argento satinato	18
UFCF42AS	Tirante snodato regolabile argento satinato	18

### SCHEDA TECNICA

Codice art.	Descrizione	L.P.
UFCF81CR	Tirante snodato fisso cromo lucido	18
UFCF82CR	Tirante snodato regolabile cromo lucido	18

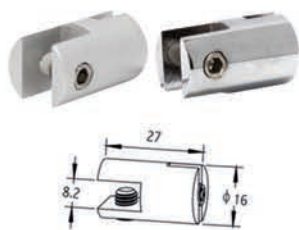

### SCHEDA TECNICA

Codice art.	Descrizione	L.P.
UFCVSAAS	Pinza laterale argento satinato	4,20
UFCVSACR	Pinza laterale cromo lucido	5,40

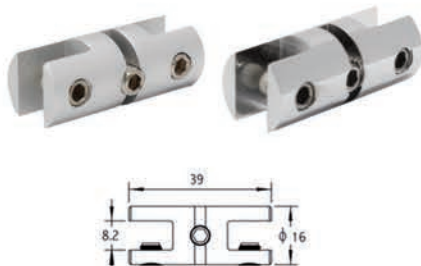

### SCHEDA TECNICA

Codice art.	Descrizione	L.P.
UFCVDAS	Pinza doppia argento satinato	6
UFCVDCR	Pinza doppia cromo lucido	7



### SCHEDA TECNICA

Codice art.	Descrizione	L.P.
FVCAV015	Cavo acciaio Ø mm 1,5 mt/l	1,20
UFFIS015	Fissacavo ottone	2
UFSTRI15	Stringicavo alluminio	1
UFSF15	Sfera stringicavo	5

# SISTEMI DI FISSAGGIO ACCIAIO E ELITE

Kit composto da tiranti, cavi in acciaio, pinze laterali singole o doppie per l'esposizione di poster all'interno di apposite tasche, sia a parete che a muro.  
Disponibile sia il kit in acciaio che quello in alluminio od ottone.

*Kit consisting of tie rods, steel cables, lateral grippers single or double for the display of poster in special pockets, either on the wall and or on the ceiling.  
Available in both steel kit and aluminum or brass kit.*

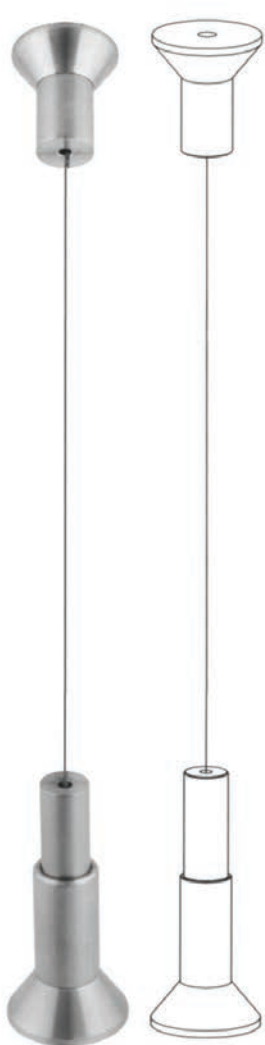

## TIRANTI CIELO TERRA

Codice art.	Descrizione	L.P.
UFSF01AC	Kit tiranti + 4 mt di cavo acciaio	27

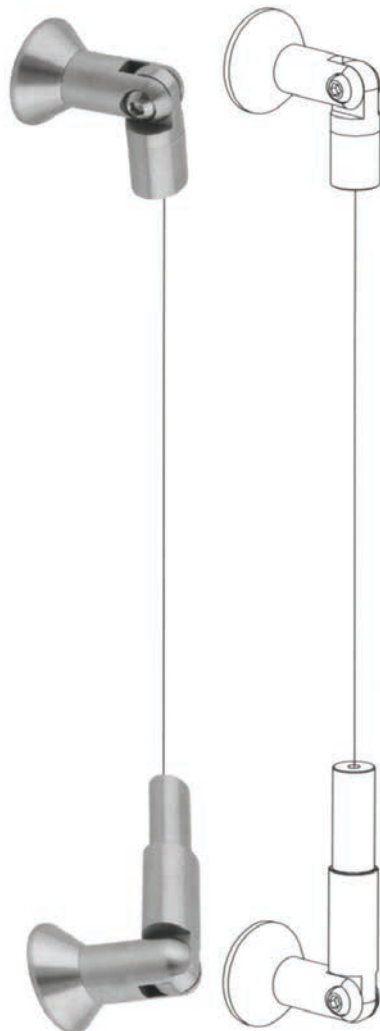

## TIRANTI DA PARETE

Codice art.	Descrizione	L.P.
UFSF02AC	Kit tiranti + 3 mt di cavo acciaio	43

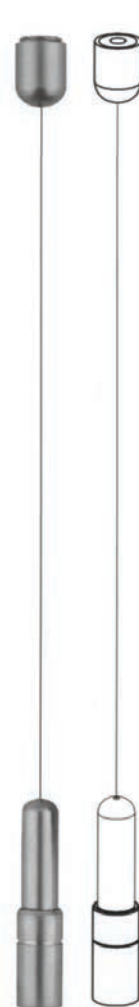

## TIRANTI CIELO TERRA

Codice art.	Descrizione	L.P.
UFAF01	Kit tiranti alluminio + 4 mt di cavo acciaio	18
UFBF01	Kit tiranti ottone + 4 mt di cavo acciaio	21

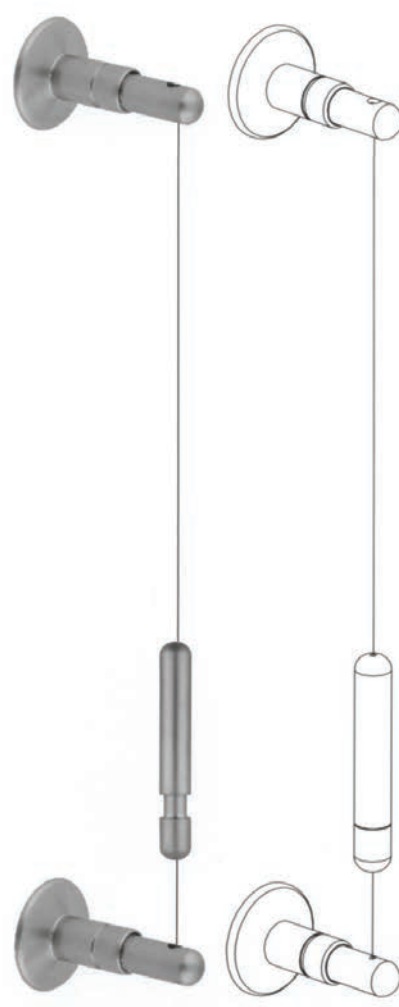

## TIRANTI DA PARETE

Codice art.	Descrizione	L.P.
UFAF02	Kit tiranti alluminio + 4 mt di cavo acciaio	37
UFBF02	Kit tiranti ottone + 4 mt di cavo acciaio	45

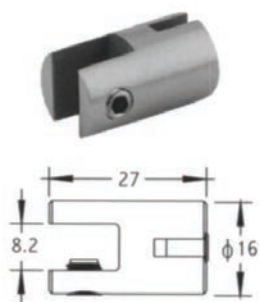

## SCHEDA TECNICA

Codice art.	Descrizione	L.P.
UFSCS	Pinza laterale acciaio	7

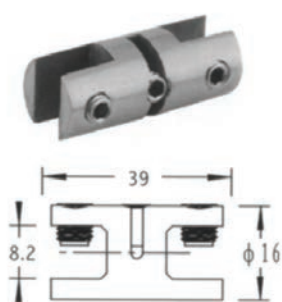

## SCHEDA TECNICA

Codice art.	Descrizione	L.P.
UFSFD	Pinza doppia acciaio	9

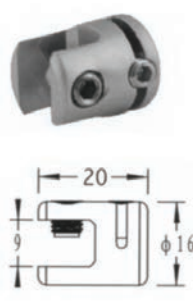

## SERIE IN ALLUMINIO SILVER SATIN

Codice art.	Descrizione	L.P.
UFAFCS	Pinza laterale argento sat.	4
UFAFD	Pinza doppia argento sat.	5

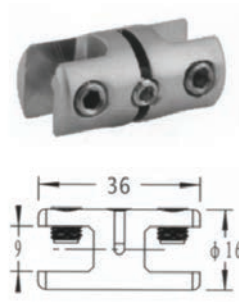

## SERIE IN OTTONE SILVER SATIN

Codice art.	Descrizione	L.P.
UFBFCS	Pinza laterale argento sat.	6
UFBFD	Pinza doppia argento sat.	7



# VELA PLEX

Tasca porta messaggi realizzata in Perspex trasparente, disponibile sia per fissaggio a parete con biadesivo, sia per fissaggio a sospensione con pinze e tiranti. È disponibile sia verticale che orizzontale.

*Pocket messages made of transparent Perspex, available for wall mounting with double-sided tape, both for suspended installation with clamps and rods. It is available in both vertical and horizontal.*

## SCHEDA TECNICA VELA SEMPLICE DA PARETE

Codice art.	Formato tasca	L.P.
EUVELSEA4	A4 verticale	10
EUVELSEA3	A3 verticale	20
EUVELSE57	B2 50x70 verticale	58
EUVELSE710	B1 70x100 verticale	85
EUVELSEA2	A2 42x59,4 verticale	50
EUVELSEA1	A1 59,4x84,1 verticale	90
EUVELSEA0	A0 84,1x118,9 verticale	225
EUVELSEA4HO	A4 orizzontale	11
EUVELSEA3HO	A3 orizzontale	20
EUVELSE57HO	B2 50x70 orizzontale	53
EUVELSE710HO	B1 70x100 orizzontale	160
EUVELSEA2HO	A2 59,4x42 orizzontale	55
EUVELSEA1HO	A1 84,1x59,4 orizzontale	112
EUVELSEA0HO	A0 118,9x84,1 orizzontale	225

## SCHEDA TECNICA VELA SAGOMATA A SOSPENSIONE

Codice art.	Formato tasca	L.P.
EUVESAA4	A4 verticale	14
EUVESAA3	A3 verticale	28
EUVESAA57	B2 50x70 verticale	80
EUVESAA710	B1 70x100 verticale	116
EUVESAA2	A2 42x59,4 verticale	60
EUVESAA1	A1 59,4x84,1 verticale	100
EUVESAA0	A0 84,1x118,9 verticale	225
EUVESAA4HO	A4 orizzontale	14
EUVESAA3HO	A3 orizzontale	28
EUVESAA57HO	B2 50x70 orizzontale	72
EUVESAA710HO	B1 70x100 orizzontale	225
EUVESAA2HO	A2 59,4x42 orizzontale	60
EUVESAA1HO	A1 84,1x59,4 orizzontale	115
EUVESAA0HO	A0 118,9x84,1 orizzontale	225

## SCHEDA TECNICA VELA SEMPLICE CON TESTATA E FORI

Codice art.	Formato tasca	L.P.
EUVELSEA4TF	A4 verticale	12
EUVELSEA3TF	A3 verticale	22
EUVELSE57TF	B2 50x70 verticale	60
EUVELSE710TF	B1 70x100 verticale	90
EUVELSEA4HOTF	A4 orizzontale	13
EUVELSEA3HOTF	A3 orizzontale	22
EUVELSE57HOTF	B2 50x70 orizzontale	60

## ALTRE MISURE SU RICHIESTA

### SCHEDA TECNICA MULTITASCA A4 VERTICALI

Codice art.	F.to tasche	N. pannelli	Tip. Tasche	N. tasche A4	L.P.
EUUSSTA42A4V	A4 verticale	4	2 x A4	8	336
EUUSSTA82A4V	A4 verticale	8	2 x A4	16	550
EUUSSTA122A4V	A4 verticale	12	2 x A4	24	744
EUUSSTA162A4V	A4 verticale	16	2 x A4	32	862
EUUSSTA43A4V	A4 verticale	4	3 x A4	12	424
EUUSSTA83A4V	A4 verticale	8	3 x A4	24	686
EUUSSTA123A4V	A4 verticale	12	3 x A4	36	948

### SCHEDA TECNICA MULTITASCA A4 ORIZZONTALI

Codice art.	F.to tasche	N. pannelli	Tip. Tasche	N. tasche A4	L.P.
EUUSSTA42A4O	A4 orizzontale	4	2 x A4	8	350
EUUSSTA82A4O	A4 orizzontale	8	2 x A4	16	520
EUUSSTA122A4O	A4 orizzontale	12	2 x A4	24	678
EUUSSTA43A4O	A4 orizzontale	4	3 x A4	12	406
EUUSSTA83A4O	A4 orizzontale	8	3 x A4	24	620

VELA SEMPLICE

VELA SAGOMATA

VELA SEMPLICE CON TESTATA E FORI

MULTITASCA 3 x A4

MULTITASCA 2 x A4

# SISTEMI DI FISSAGGIO RIGIDO

Soluzione espositiva per l'affissione a parete di targhe, pannelli o tasche porta messaggi. Il sistema è composto da fissaggi a parete, barra a sezione circolare e pinze scorrevoli; tutte le unità scorrevoli si bloccano mediante serraggio delle viti a scomparsa. Disponibili in versione cromo lucido o argento satinato.

*Exhibition solution for fixing plates on the wall, panels or pocket messages. Kit consisting of fixing on the wall, circular section rod and sliding clamps; All the sliding units are fixed by tightening retractable screw.*



## SCHEDA TECNICA SISTEMI FISSAGGIO ALLUMINIO SATINATO

Codice art.	Descrizione	L.P. cad.
UFRF01AS	Sostegno a parete singolo argento satinato	9
UFRVSAS	Pinza laterale singola argento satinato	6
EUTUB010AS	Barra tonda diam mm.10 argento satinato, al mt/l	15

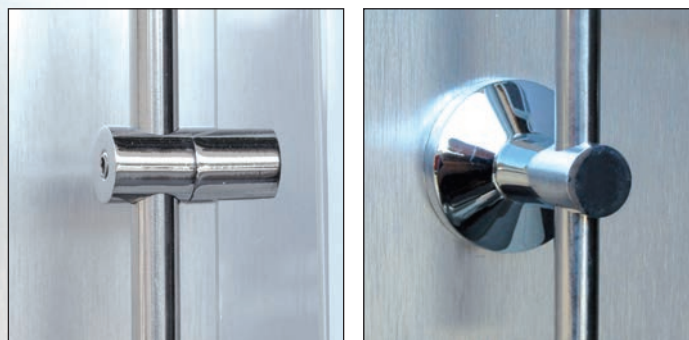

## SCHEDA TECNICA SISTEMI FISSAGGIO CROMO LUCIDO

Codice art.	Descrizione	L.P. cad.
UFRF01CR	Sostegno a parete singolo	14
UFRV01CR	Pinza laterale singola	7
EUTUB010	Tubo diam. mm 10 al mt/l	15

# SISTEMI DI FISSAGGIO QUADRI

Elegante serie di profili, cavi e ganci in alluminio e acciaio per il fissaggio di cornici e quadri all'interno di spazi espositivi.

Smart solution made of steel and aluminum profiles, wires and hooks to fix frames and pictures in exhibiting spaces.



## PROFILI

### SCHEDA TECNICA PROFILO FISSAGGIO A MURO T101

Codice art.	Descrizione	Lunghezza cm.	Finitura	Portata massima kg	L.P.
UFT101	Profilo alluminio	200	Alluminio anodizzato	50	22

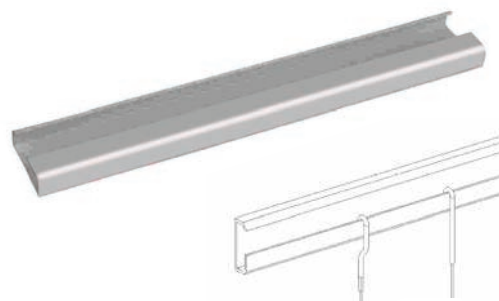
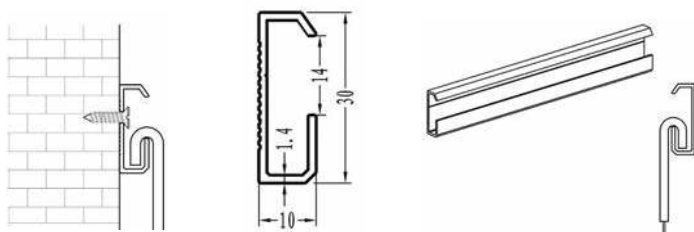

### SCHEDA TECNICA PROFILO FISSAGGIO DA SOFFITTO T102

Codice art.	Descrizione	Lunghezza cm.	Finitura	Portata massima kg	L.P.
UFT102	Profilo alluminio	200	Alluminio anodizzato	50	30

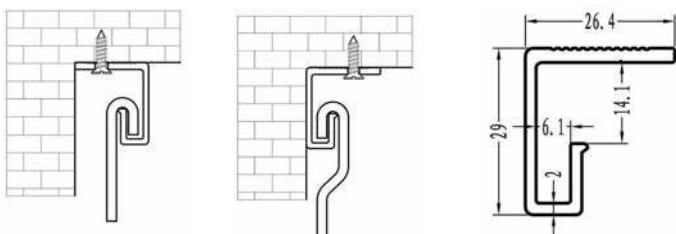

Montaggio nascosto

Montaggio a vista

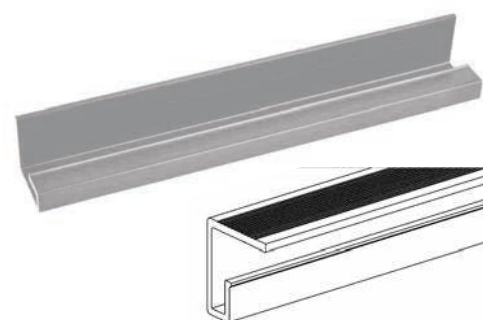

## CAVI

### SCHEDA TECNICA CAVO ACCIAIO C004

Codice art.	Descrizione	Lunghezza cm.	Portata massima kg	L.P.
UFC004S300CM	Cavo acciaio inossidabile	300	20	4

### SCHEDA TECNICA CAVO ACCIAIO C005

Codice art.	Descrizione	Lunghezza cm.	Portata massima kg	L.P.
UFC005S300CM	Cavo acciaio inossidabile	300	20	4

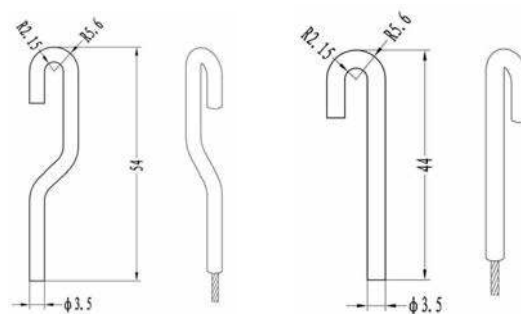

## GANCI



### SCHEDA TECNICA GANCIO HK-0001

Codice art.	Descrizione	Portata max Kg	L.P.
UFHK0001	Gancio in acciaio per cavo max $\phi$ mm. 2	15	4

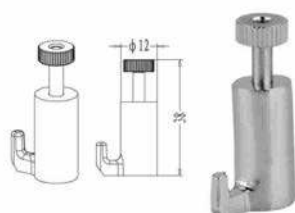

### SCHEDA TECNICA GANCIO HK-0007

Codice art.	Descrizione	Portata max Kg	L.P.
UFHK0007	Gancio in acciaio per cavo max $\phi$ mm. 2	15	6

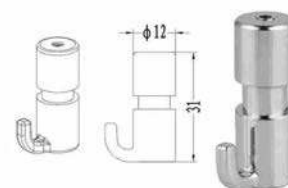

### SCHEDA TECNICA GANCIO HK0007A

Codice art.	Descrizione	Portata max Kg	L.P.
UFHK0007A	Gancio in acciaio per cavo max $\phi$ mm. 2	15	6

# MAGNETIC LIGHT BOX

Soluzione espositiva per valorizzare messaggi rivolti al pubblico, composta da tasca trasparente in Perspex con integrati serie di LED; grazie allo speciale pannello acrilico, la luminosità è intensa e omogenea e risalta la grafica esposta. La tasca è fissata mediante cavi di acciaio e fissaggi a soffitto; gli stessi hanno anche la funzione di cablaggio elettrico in bassa tensione a 12 Volt. Le tasche sono disponibili nei formati A4 e A3 nella versione monofacciale.

*Expositive solution to valorize messages to the public, consisting of a transparent Perspex pocket with LED in it; thanks to the special acrylic panel, the brightness is intense and homogeneous and gives valor to the exposed graphic. The pocket is fixed through steel wires and ceiling fittings, which also have the function of electric wiring in 12 Volt low tension. Pockets are available in A4 and A3 monofacial format, either horizontal and vertical.*



LED PANEL VERTICALE



LED PANEL ORIZZONTALE



**VEDI ISTRUZIONI DI MONTAGGIO A PAG. 93**

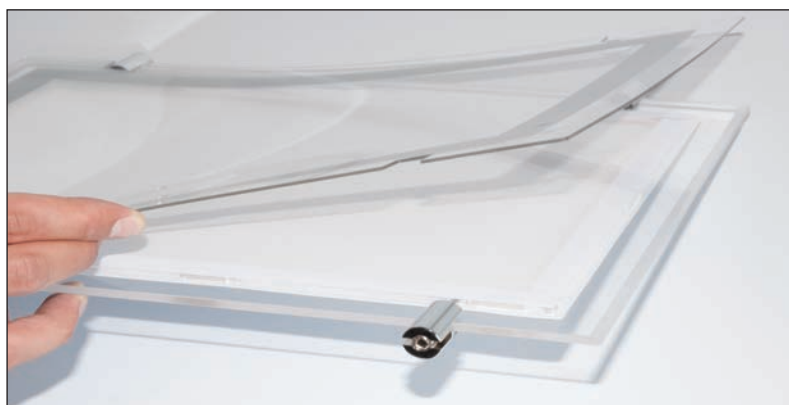

## SCHEMA TECNICA

Code art.	Descrizione	Dim. cornice mm.	Dim. grafica mm.	Spess. cornice mm.	Volt	Potenza Watt	L.P.
UFLBBA4P	Led Pannel f.to A4 verticale	363x276	297x210	8	24	4,8	165
UFLBBA4L	Led Pannel f.to A4 orizzontale	363x276	297x210	8	24	4,8	165
UFLBBA3P	Led Pannel f.to A3 verticale	486x363	420x297	8	24	4,8	220
UFLBBA3L	Led Pannel f.to A3 orizzontale	486x363	420x297	8	24	4,8	220
ETGS1512	Alimentatore Wall Mount 12V 15W 1,25A				24	15	51
ETGS4012	Alimentatore Desktop 12V 40W 3,34A				24	40	49
ETGS9012	Alimentatore Desktop 12V 80W 6,67A				24	80	109
UF2M	Cavo alimentazione con spinotto						5
UFBf0155	Kit sosp. Attacchi cielo/terra + cavo acciaio + isolanti						24
UFCF08	Connettore alimentazione						3
ETSPINA	Spina per alimentatore desktop						10



# BANDIERE

FLYING BANNER KIT  
FLYING BASE  
ACCESSORI FLYING BANNER KIT  
SPINNER FLAG  
WIND FLAG  
NEW FLAG  
BANNER FLAG  
METAL FLAG  
TRIPOLE  
GIGAFLAG  
BORDER, CORNER, ANGLE FLAG  
BANNER STAND & MAXI  
KINGFLAG

# FLYING BANNER KIT

new  
PRODUCT

Struttura a bandiera da pavimento, composta da base incrociata in metallo e asta verticale in alluminio con innesti a baionetta ed ultimo segmento in fibra di plastica, il tutto zavorrabile con la ciambella in dotazione. Disponibile in tre tipologie diverse, ha la sacca di trasporto compresa nel prezzo.

*Structure flag floor, consisting of a base metal and cross-vertical rod aluminum with bayonet fitting and last segment of plastic fiber, all supplied with the ring-shaped object provided. Available in three different types, it has the transport bag included.*

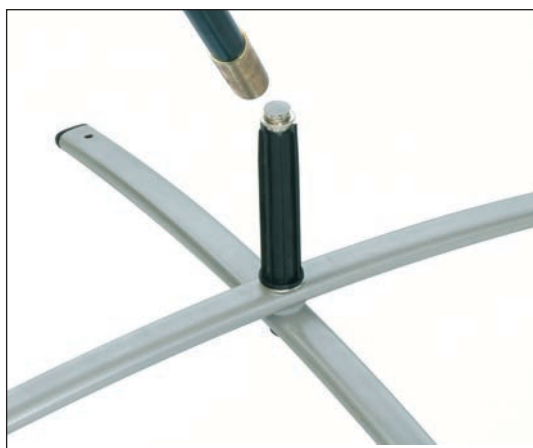

## SCHEMA TECNICA

Codice art.	Lunghezza asta cm.	Modello	Sacca cm.	Peso Kg	L.P.
AIFLYBAS	260	S	20x97	5	55
AIFLYBASM	350	SM	20x97	5	60
AIFLYBAM	400	M	20x120	5,2	65
AIFLYBAML	450	ML	20x120	5,2	70
AIFLYBAL	500	L	20x120	5,4	75
AIFLYBAXL	550	XL	20x120	5,4	80

# FLYING BANNER KIT

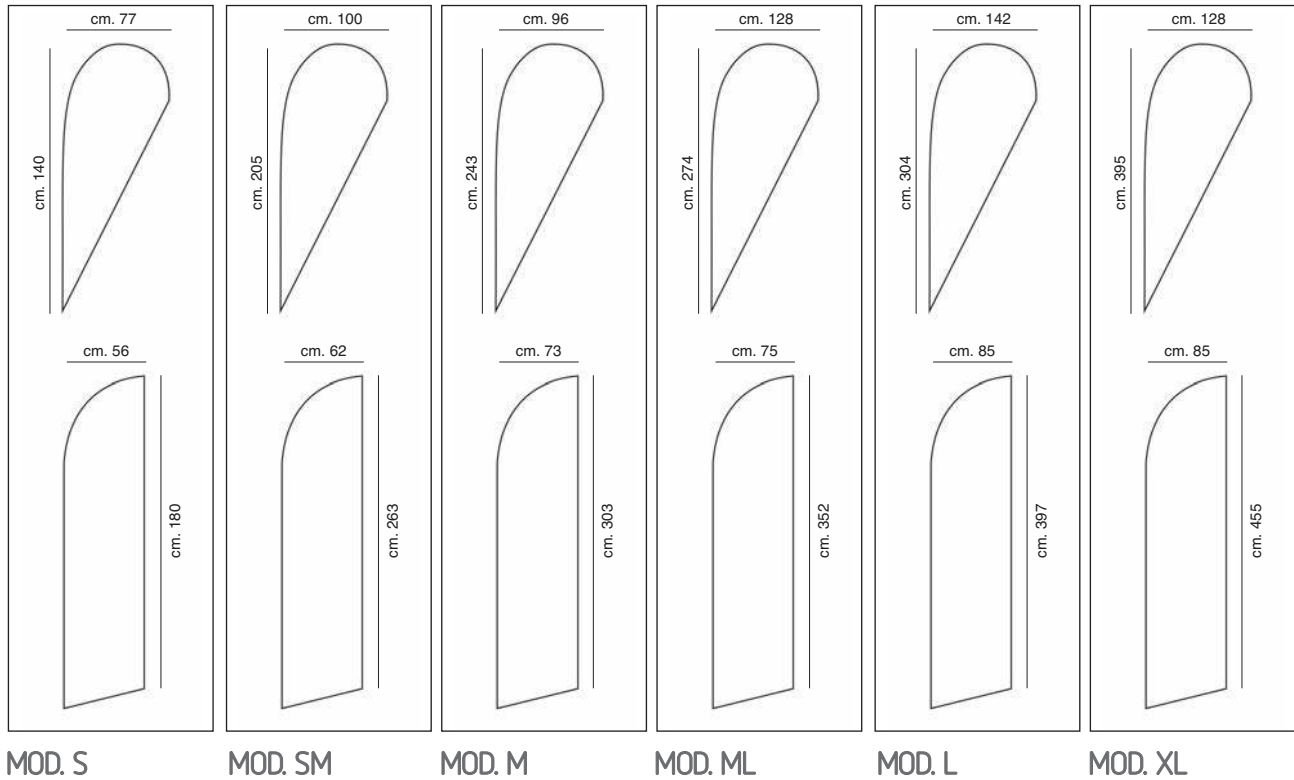

## FLYING BASE

Portabandiera composto da asta telescopica in fibra acrilica e base piatta in metallo da pavimento, con possibilità di aggiungere la zavorra per una maggiore stabilità.

Flag bearer made up telescopic rod made of acrylic fiber and a flat metal base from the floor with the possibility of adding the ballast for greater stability.

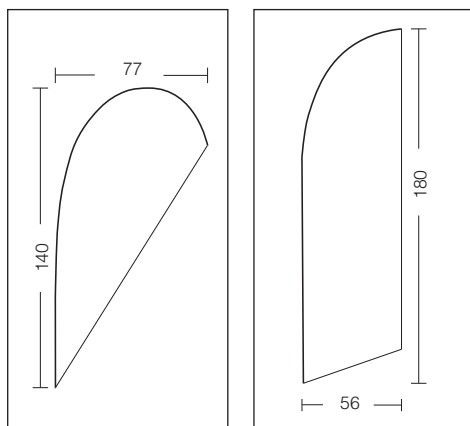

### SCHEMA TECNICA

Codice art.	Asta cm.	Sacca cm.	Base cm.	Peso Kg	L.P.
DWFLYBASE	240	10x20x130	30x21	2,5	40



cm 240

# ACCESSORI FLYING BANNER KIT

## SCHEDA TECNICA MOD. S

Codice art.	Descrizione	L.P.
AIASTAS	Asta Flying banner mod. S	23

## SCHEDA TECNICA MOD. SM

Codice art.	Descrizione	L.P.
AIASTASM	Asta Flying banner mod. SM	26



## SCHEDA TECNICA MOD. M

Codice art.	Descrizione	L.P.
AIASTAM	Asta Flying banner mod. M	30

## SCHEDA TECNICA MOD. ML

Codice art.	Descrizione	L.P.
AIASTAML	Asta Flying banner mod. ML	32



## SCHEDA TECNICA MOD. L

Codice art.	Descrizione	L.P.
AIASTAL	Asta Flying banner mod. L	36

## SCHEDA TECNICA MOD. XL

Codice art.	Descrizione	L.P.
AIASTAXL	Asta Flying banner mod. XL	40



## SCHEDA TECNICA

Codice art.	Descrizione	Misura cm.	L.P.
AIFLYBAX	Base incrociata Flying Banner mod. S, M e L	68x83	22

## SCHEDA TECNICA

Codice art.	Descrizione	L.P.
DWFLYZAV	Zavorra Flying banner mod. S, M e L	10

## SCHEDA TECNICA

Codice art.	Descrizione	Misura cm.	L.P.
DWFLYSAC	Sacca Flying Banner mod. S, M e L	120x20	12

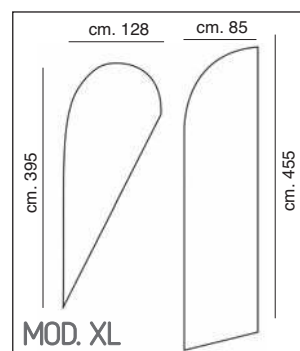
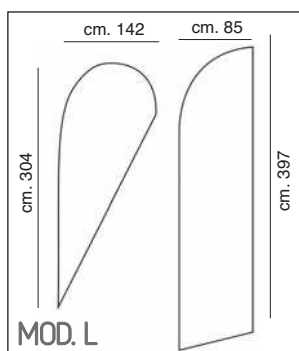
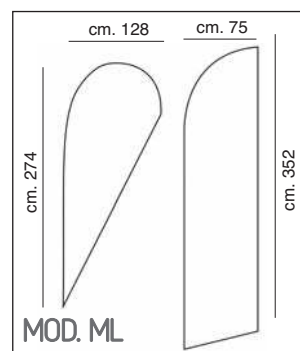
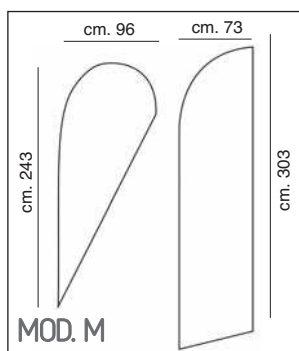
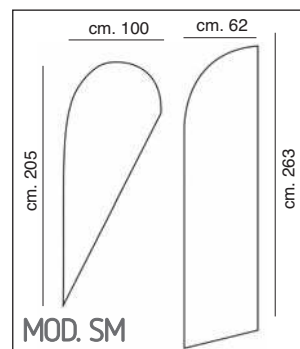
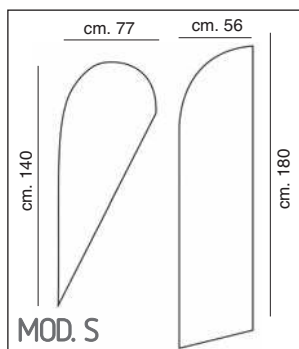





#### SCHEDA TECNICA

Codice art.	Descrizione	Misure cm.	Peso Kg	L.P.
DWFLYB1	Base incrociata in metallo	100x100	3	64



#### SCHEDA TECNICA

Codice art.	Descrizione	Misure cm.	Peso Kg	L.P.
AIFLYBA2	Base piatta in metallo	30x30	6	60
FLYFB8A44	Base piatta in metallo	40x40	8	80
FLYFB8A55	Base piatta in metallo	50x50	11	100



#### SCHEDA TECNICA

Codice art.	Descrizione	Misure cm.	L.P.
DWFLYBA3	Base a croce con contenitore riempibile	73x73	75



#### SCHEDA TECNICA

Codice art.	Descrizione	L.P.
DWFLYBA4	Base a forcella	45

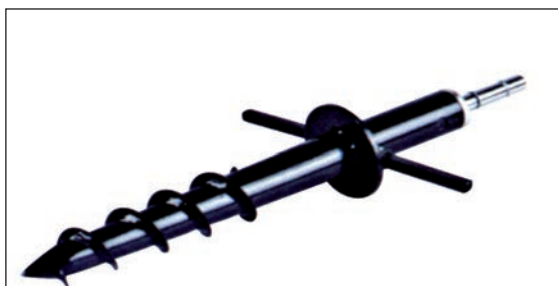

#### SCHEDA TECNICA

Codice art.	Descrizione	Profondità cm.	L.P.
DWFLYPER	Perno a vite per sabbia	31	60



#### SCHEDA TECNICA

Codice art.	Descrizione	L.P.
AIFLYPIC	Picchetto per terreno	18



#### SCHEDA TECNICA

Codice art.	Descrizione	L.P.
DWFLYBA6	Base incrociata	50

# SPINNER FLAG



Struttura per bandiera in tubolare di alluminio verniciato nero, ad innesto; l'ultimo segmento in fibra di vetro, che garantisce la flessibilità corretta per la curvatura superiore. È disponibile con sacca in tessuto per riporre le aste e la grafica. La base, a scelta, è fornita separata.

Structure for flag with black painted aluminum rod plus insert. The upper corner flexibility is guaranteed by the glass fiber. Supplied with a carrying bag to set to rights the rods and graphic too. The base is supplied separate.

BANDIERE

184

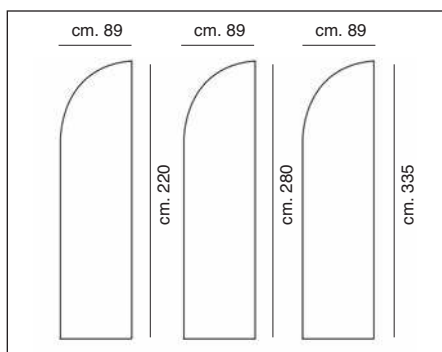

**ATTENZIONE!**  
base non compresa,  
specificare sempre la versione desiderata

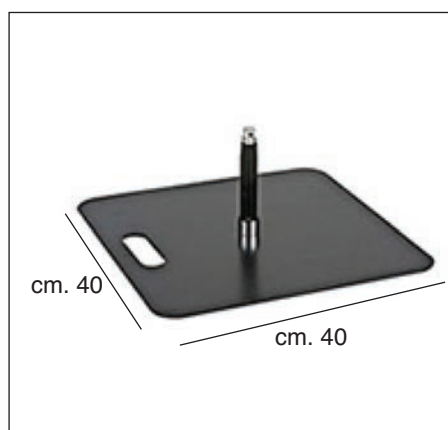

BASE PIATTA



BASE RIEMPIBILE

## SCHEMA TECNICA

Codice art.	Descrizione	Dim. grafica cm.	L.P.
DWSPIN200	Kit aste spinner flag + sacca cm.89x220	89x260	38
DWSPIN240	Kit aste spinner flag + sacca cm.89x280	89x320	42
DWSPIN345	Kit aste spinner flag + sacca cm.89x335	89x375	46
DWBASE13	Base riempibile in plastica		50
DWBASE01	Base metallica piatta		80

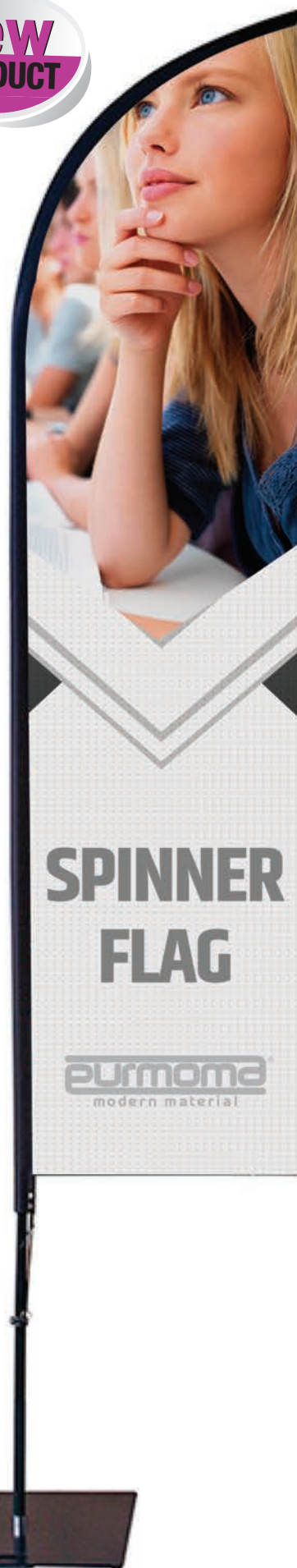

cm 260/320/375

# WIND FLAG

Struttura per bandiera in tubolare di alluminio verniciato nero, diam. 28 mm., ad innesto con curva fissa. È disponibile con sacca in tessuto per riporre le aste e la grafica. La base, a scelta, è fornita separata. Disponibile in tre formati di grafica, cm. 60x155, cm. 85x265 e cm. 85x375.

Structure for flag with black painted aluminum pole, 28mm. diameter, insert with unmoveable corner. Supplied with carrying bag to set to rights the rods and graphic too. The base is supplied separate. Available sizes 60x155 cm; 85x265 cm; 85x375 cm.

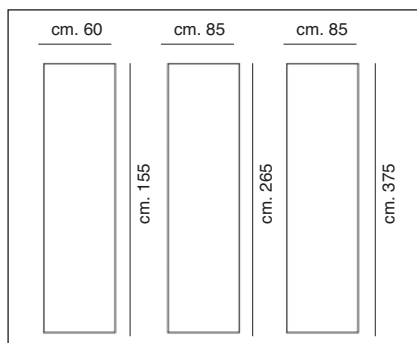

**ATTENZIONE!**  
base non compresa,  
specificare sempre la versione desiderata

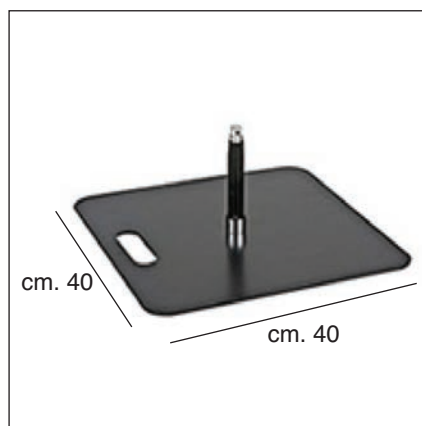

BASE PIATTA



BASE RIEMPIBILE



## SCHEMA TECNICA

Codice art.	Descrizione	Dim. grafica cm.	L.P.
DWWIND6015	Kit aste wind flag + sacca cm. 60x230	60x155	42
DWWIND8526	Kit aste wind flag + sacca cm. 60x335	85x265	50
DWWIND8537	Kit aste wind flag + sacca cm. 60x445	85x375	58
DWBASE13	Base riempibile in plastica		50
DWBASE01	Base metallica piatta		80

# NEW FLAG

Struttura per bandiera in tubolare di alluminio verniciato nero, con base riempibile in plastica. Steli fissi, per comporre una grafica di cm.80x240.

Structure for flag with black painted aluminum pole and refillable plastic base. Permanent rod to make the graphic, which is 80x240cm size.

**new  
PRODUCT**



cm 240

cm 366

cm 80

## SCHEMA TECNICA

Codice art.	Descrizione	Dim. grafica cm.	Peso kg.	L.P.
DWNFLAG	Kit new flag + base	80x240	3,3	100

# BANNER FLAG

Struttura componibile porta stendardo per uso interno ed esterno, composta da un'asta verticale da mt.3 e una orizzontale in alluminio anodizzato da cm. 70, con base incrociata; grafica dimensioni cm 70x260, sacca per il trasporto inclusa nel prezzo.

*The door pennant combinable structure for indoor and outdoor use, composed of a vertical rod mt. 3 high and an horizontal rod in anodized aluminum cm. 70 long, with cross base; graphic dimensions cm. 70x260, carrying bag included in the price.*

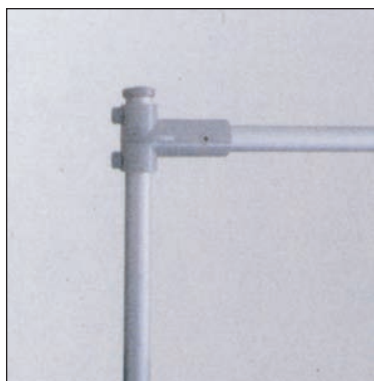

## SCHEDA TECNICA

Codice art.	Banner cm.	Sacca cm.	Misura base cm.	Peso Kg.	L.P.
DWBAFLAG	70x260	41x29x107	82x68	4,7	75



# METAL FLAG

Struttura portabandiera con asta verticale telescopica, asta orizzontale girevole e base richiudibile mediante sistema a compassi. Altezza cm. 528, grafica cm. 100x400.

*Flag-bearer structure with telescopic vertical rod, horizontal swivel rod and resealable base by a compasses system. Height. cm 528, graphic cm. 100x400.*

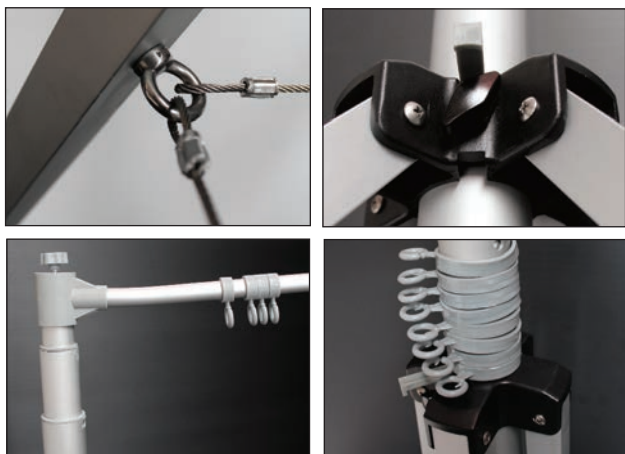

## SCHEDA TECNICA

Codice art.	Grafica cm.	Altezza cm.	Sacca cm.	Peso Kg.	L.P.
UTMEFLAG	100x400	528	20x20x170	20	200



# TRIPOLE

Struttura componibile per bandiera o stendardo, sia per esterni che per interni, asta verticale in alluminio telescopica, base cava riempibile diametro cm. 70. Altezza totale c.ca mt. 4, grafica cm. 80x280.

*Combinable structure for the flag or banner, for both outdoor and indoor, telescopic vertical aluminum rod, hollow base refillable diameter cm. 70, total height about mt. 4, graphics cm. 80x280.*



cm 280

cm 80

cm 400

## SCHEMA TECNICA

Codice art.	Altezza cm	Grafica cm	Sacca telaio cm	Sacca base cm	Peso Kg.	L.P.
DWTRIPOLE	400	80x280	14x16x160	30x69x69	11	240

# GIGAFLAG

Struttura componibile per stendardo o bandiera, sia da interno che da esterno; l'asta verticale è telescopica ed ha un'altezza massima di mt 5,4, mentre quella orizzontale è fissa. Banner dimensioni cm 300x110, base cava riempibile dim. cm. 80x80 e sacca inclusa nel prezzo.

*Combinable structure for banner or flag, both indoor and outdoor; the vertical rod is telescopic and has a maximum height of 5.4 meters, while the horizontal is fixed. Banner size 300x110 cm, hollow base size 80x80 cm can be filled and bag included in the price.*



cm 300

cm 110

altezza asta max cm 540

## SCHEDE TECNICA GIGAFLAG

Codice art.	Grafica cm.	Altezza cm.	Sacca telaio cm.	Sacca base cm.	Peso Kg.	L.P.
DWGIGAMO	110x300	540	162x13x15	81x42x43	16	260

## BORDER FLAG

Struttura adatta per l'esposizione di stendardi su palo o a parete; il kit comprende due aste di lunghezza cm.90, serie di fascette per il fissaggio a palo; questo kit, altamente resistente e durevole, presenta 2 molle adatte a scaricare l'energia del vento.

Questa struttura può contenere un banner di larghezza massima di cm.90.

*Structure suitable to exposure banner on the pole or on the wall. This kit included 2 rods, each 90cm high and plenty of bands to fix on the pole; This kit is durable and resistant, and it's able to let off the wind's power.*

## CORNER FLAG

Struttura adatta per l'esposizione di stendardi su palo o a parete; il kit comprende due aste di lunghezza cm.60, serie di fascette per il fissaggio a palo; prodotto entry level, adatto in luoghi non soggetti a forte vento e condizioni climatiche estreme.

Questa struttura può contenere un banner di larghezza massima di cm.60.

*Structure suitable to exposure banner on the pole or on the wall. This kit included 2 rods, each 60cm high and plenty of bands to fix on the pole; This product entry level is not suitable for a windy areas and bad climate conditions. This structure is able to hold a banner which must be 60cm long maximum.*

## ANGLE FLAG

Struttura adatta per l'esposizione di stendardi su palo o a parete; il kit comprende 1 sola asta, inclinata verso l'alto, di lunghezza cm.60, serie di fascette per il fissaggio a palo; prodotto entry level, adatto in luoghi non soggetti a forte vento e condizioni climatiche estreme.

Questa struttura può contenere un banner di larghezza massima di cm.60.

*Structure suitable to exposure banner on the pole or on the wall. This kit included 1 rod, tilted upwards, each 60cm high and plenty of bands to fix on the pole; This product entry level is not suitable for a windy areas and bad climate conditions.*

*This structure is able to hold a banner which must be 60cm long maximum.*





## BORDER FLAG

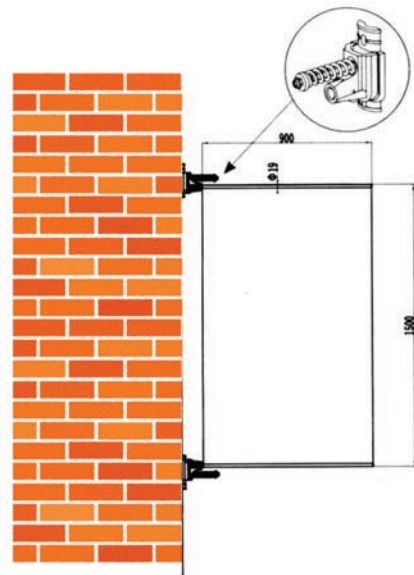
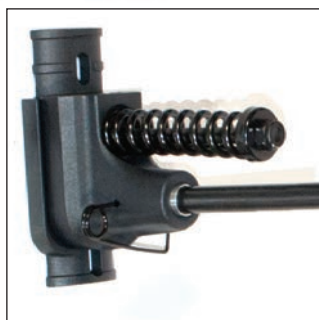

### SCHEDA TECNICA BORDER FLAG

Codice art.	Altezza cm.	L.P.
UFBORFLAG	Kit Border Flag largh. cm.90	200

## CORNER FLAG

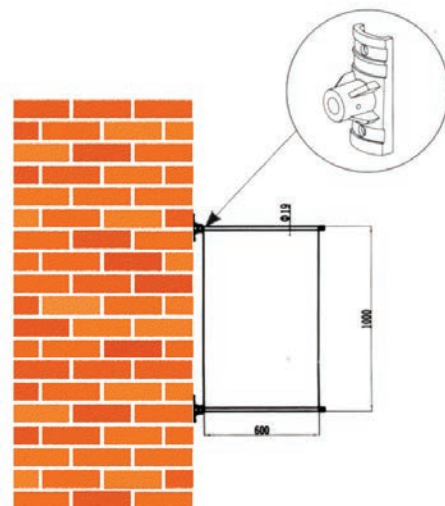

### SCHEDA TECNICA CORNER FLAG

Codice art.	Altezza cm.	L.P.
UFCORFLAG	Kit Corner Flag largh. cm.60	100

## ANGLE FLAG

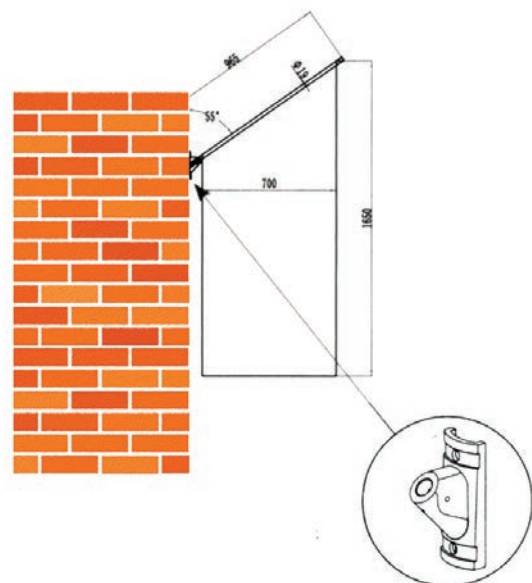

### SCHEDA TECNICA ANGLE FLAG

Codice art.	Altezza cm.	L.P.
UFANGFLAG	Kit Angle Flag largh. cm.60	50

# BANNER STAND & MAXI

Strutture autoportanti bifacciali composte da barre in alluminio e basi cave riempibili; il Banner Stand permette il fissaggio di due banner dimensioni cm 240x245, mentre la versione Maxi sorregge un banner da cm 570x240. Le sacche per il trasporto sono incluse nella dotazione.

*Double-sided self-supporting structures made from aluminum bars and hollow fillable bases; Banner Stand allows the attachment of two banner sizes 240x245 cm, while the Maxi version holds up a banner 570x240 cm. The bags for transportation are included in the equipment.*



## SCHEMA TECNICA

Codice art.	Banner cm.	Sacca telaio cm.	Sacca base cm.	Peso Kg.	L.P.
DWBASTE	240x245	172x13x15	85x30x51	19	400
DWBASTMX	570x240	172x15x17	85x30x47	39	700

# KINGFLAG

Pennone portabandiera da esterno costituito da tronconi ad innesto e fissaggio con viti e piede di base in acciaio. Disponibili con altezze standard di mt. 6, mt. 8, mt. 9, mt. 10 e mt. 12, su richiesta anche nelle altezze di mt. 14, mt. 16 e mt. 18. La struttura si può avere nelle due diverse varianti acciaio inox e alluminio verniciato bianco. Gli schemi nelle pagine seguenti si riferiscono alla versione in alluminio bianco.

*Flagpole standard-bearer for outdoor use made of sections in connection and fixing through screws and steel base foot. Available in the standard heights of mt. 6, mt. 8, mt. 9, mt. 10 and mt. 12, on request in heights of mt. 14, mt. 16 and mt. 18. Structure is available both in steel and white painted aluminum. The schemes on the following pages refer to the white aluminum one.*

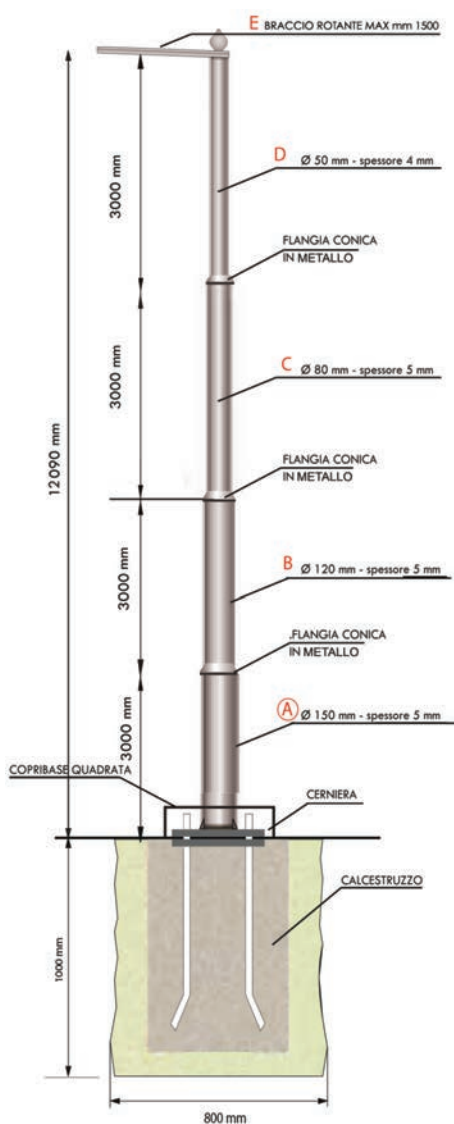

## KINGFLAG 12

### SCHEMA TECNICO KINGFLAG MT. 12

Dimensioni massime consigliate bandiera cm. 150x600

Codice art.	Finitura	Peso Kg.	Imballo cm.	L.P.
CKKINGAVB12	Alluminio verniciato bianco	96	330x40x40	2775
CKKINGNOX12	Acciaio inox	134	330x40x40	3115

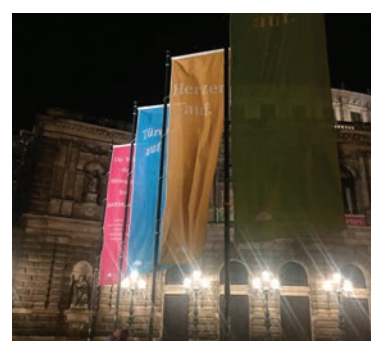
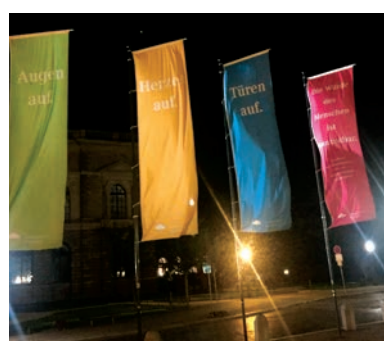

# KINGFLAG

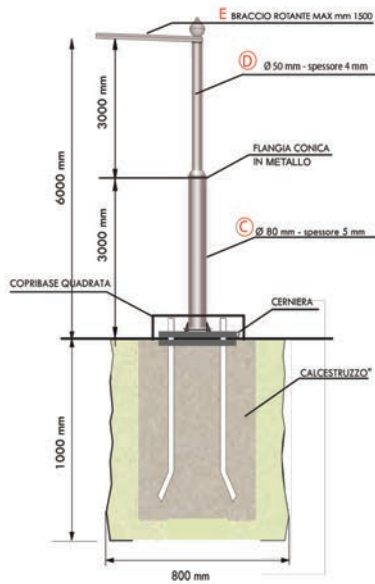

## KINGFLAG 6

### SCHEDA TECNICA KINGFLAG MT. 6

Dimensioni massime consigliate bandiera cm. 80x300

Codice art.	Finitura	Peso Kg.	Imballo cm.	L.P.
CKKINGAVB6	Alluminio verniciato bianco	32	330x25x25	1230
CKKINGNOX6	Acciaio inox	63	330x25x25	1500

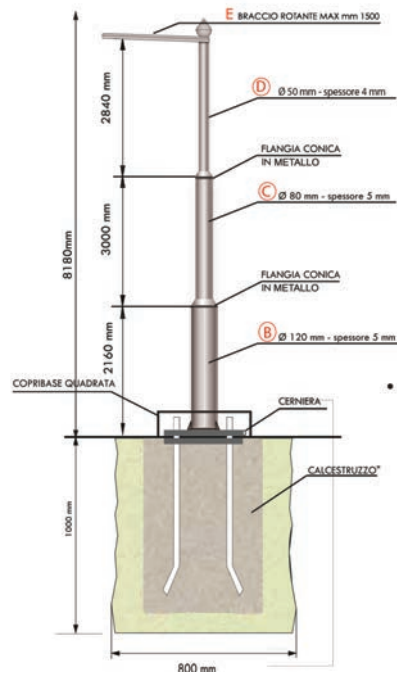

## KINGFLAG 8

### SCHEDA TECNICA KINGFLAG MT. 8

Dimensioni massime consigliate bandiera cm. 100x400

Codice art.	Finitura	Peso Kg.	Imballo cm.	L.P.
CKKINGAVB8	Alluminio verniciato bianco	48	330x25x25	1530
CKKINGNOX8	Acciaio inox	81	330x25x25	1850

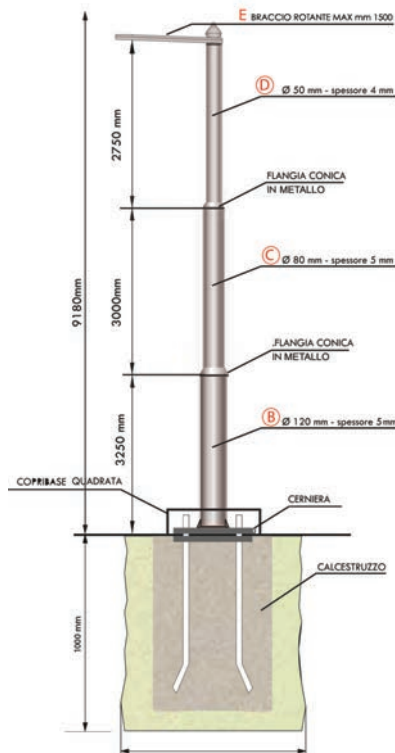

## KINGFLAG 9

### SCHEDA TECNICA KINGFLAG MT. 9

Dimensioni massime consigliate bandiera cm. 120x450

Codice art.	Finitura	Peso Kg.	Imballo cm.	L.P.
CKKINGAVB9	Alluminio verniciato bianco	54	330x25x25	1750
CKKINGNOX9	Acciaio inox	90	330x25x25	2150

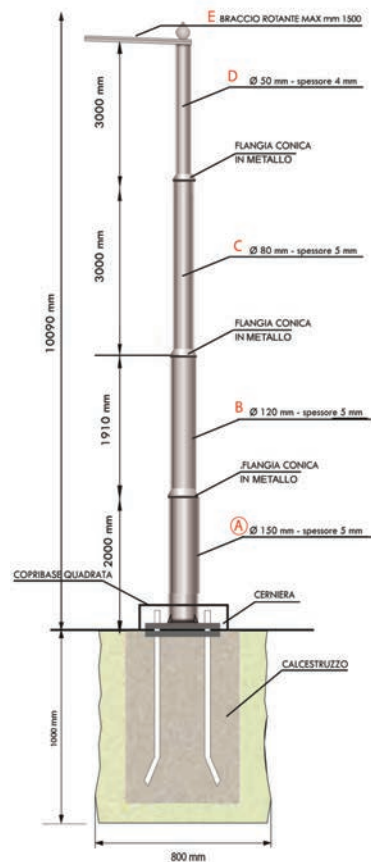

## KINGFLAG 10

### SCHEDA TECNICA KINGFLAG MT. 10

Dimensioni massime consigliate bandiera cm. 150x500

Codice art.	Finitura	Peso Kg.	Imballo cm.	L.P.
CKKINGAVB10	Alluminio verniciato bianco	85	330x40x40	2320
CKKINGNOX10	Acciaio inox	110	330x40x40	2750

# KINGFLAG KIT



## PIEDE IN ACCIAIO

Piede in acciaio composto da canotto, piastra con 4 sole e cerniera (per fondazioni gettate in opera).



## PIASTRA DI BASE

Piastra di base con 4 fori e cerniera, completa di barre filettate e bulloneria per fondazioni gettate in opera.



## KIT BULLONERIA

- 4 dadi 20MA
- 4 rondelle foro 24
- 8 viti M10x30/20 bianca
- 3 viti auto-foranti
- 4 viti M5x10+rondella+dado
- 1 morsetto +moschettone
- 1 bullone M10x120+coppiglia+rondelle



## PESO TENDI BANDIERA

Codice art.	Descrizione	L.P.
REPESO	Peso tendi bandiera	116



## BRACCIO ROTANTE

Braccio rotante in alluminio, a richiesta si può avere su misura, lunghezza max cm. 150.



## ANELLI DI TENUTA

Codice art.	Descrizione	L.P.
REANELLIPVC	Anelli di tenuta in PVC bianco	14,80



## TRONCONI ASTA

Tronchi asta, disponibili in acciaio inox o alluminio verniciato bianco.



## POMO TERMINALE (Optional)

Codice art.	Descrizione	L.P.
REPOMOM10	Pomo terminale asta	88

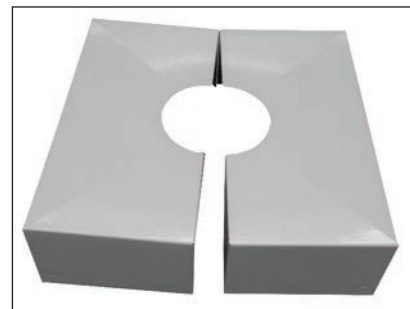

## COPRIBASE (Optional)

Codice art.	Descrizione	L.P.
CKCB689IS	Copribase Kingpole mt. 6-8-9 in acciaio inox satinato	155
CKCB689VB	Copribase Kingpole mt. 6-8-9 metallo verniciato bianco	125
CKCB1012IS	Copribase Kingpole mt. 10-12 in acciaio inox satinato	236
CKCB1012VB	Copribase Kingpole mt. 10-12 in metallo verniciato bianco	192

## ISTRUZIONI DI MONTAGGIO

1. Realizzazione plinto di fondazione secondo le indicazioni di indagine geologica. Gettata di calcestruzzo tipo RCK 300 o superiore, quindi a calcestruzzo ancora fresco inserire e posizionare l'anima di base. Attendere i tempi di asciugatura.

2. Per il montaggio del pennone inserire il tronco B nel tronco A, facendo combaciare i fori di riscontro, quindi serrare le viti in dotazione. Ove necessario ripetere l'operazione con il tronco C nel B e D nel C, quindi completare l'allestimento con il montaggio della bandiera.

Durante questa operazione è importante rispettare i seguenti parametri:

2.1 La barra filettata deve rispecchiare la quota indicata al punto "E" che è variabile in relazione all'altezza

del pennone:

- Pennoni altezza metri 6-8-9, E= mm. 48
- Pennoni altezza metri 10-12, E= mm. 65

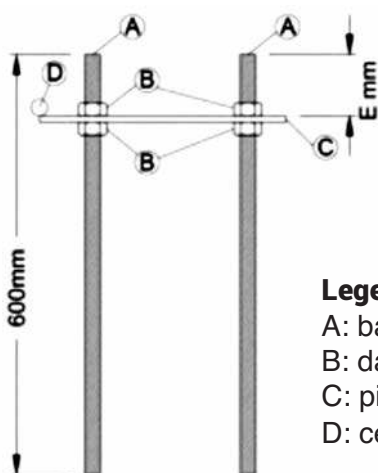

### Legenda

- A: barra filettata
- B: dado
- C: piastra in ferro
- D: cerniera

2.2 La cerniera deve essere posizionata verso una zona libera da ostacoli (pareti, alberi, cavi elettrici aerei, etc.) per almeno l'altezza del pennone;

2.3 La piastra C in ferro deve essere posizionata perfettamente in bolla rispetto al piano.

3. Allineare la cerniera della base del pennone con quella dell'anima precedentemente murata, inserire il perno nella prima sezione diam. mm. 150 ed agganciare il contrappeso prima di issare il pennone.

4. Issare il pennone per avvitare i dadi con apposite rondelle, agire sui dadi posti tra il piede e l'anima di base per la regolazione della messa a piombo del pennone, quindi serrare i dadi superiori.

5. Se presente, montare il copribase (optional) nel modo seguente:

5.1 Svitare la prima vite superiore di serraggio del palo portabandiera al piede in acciaio

5.2 Accostare i due elementi del copribase, facendo combaciare i fori degli stessi, quindi montare le viti con i dadi in dotazione serrando con cura

5.3 Far scendere il copribase oltrepassando il primo foro e riavvitare la vite superiore, quindi svitare la vite inferiore per consentire la discesa completa del copribase avendo cura di non graffiare la verniciatura

5.4 Asportare la pellicola di protezione e quindi riavvitare la vite inferiore serrando con decisione.

5.5 Sigillare il copribase al palo con il silicone colore bianco

### Controlli di sicurezza e manutenzione

Controllo di sicurezza periodico ogni 2 mesi:

Verifica del corretto posizionamento delle viti di unione tra il tronco A ed il piede del pennone e del tronco B con il tronco A. In caso di viti allentate provvedere al nuovo serraggio delle stesse con utilizzo di frena filetti forte.

Scuotere manualmente il pennone verificando che non ci siano oscillazioni tra il piede e l'anima di base (qualora fossero allentati i dadi si avvertirebbero dei movimenti alla base). Nel caso in cui si avvertissero movimenti, provvedere al controllo di sicurezza semestrale con la verifica della coppia di serraggio.

Controllo di sicurezza periodico ogni 6 mesi:

1. Smontare il copribase (se presente)
2. Verifica del corretto posizionamento delle viti di unione del tronco B con il tronco A
3. Controllare che i dadi siano ben stretti
4. Controllare lo stato di usura della bulloneria (dadi e rondelle) e, se necessario, sostituirli. Verificare che le barre filettate non siano intaccate da ruggine, in tal caso dare un film di protezione con zinco spray o prodotti similari.





# PORTAPANNELLI

INVISIBILE CLASSIC, QUADRO  
E XXQUADRO  
PIEDISTALLO TONDO  
PIEDISTALLO ELLISSE  
MAXI PIEDE  
PORTAPANNELLI WING  
EUROPIEDE  
PORTAPANNELLI FRECCIA  
PORTAPANNELLI PERSPEX  
FLAP  
BASE PLAST

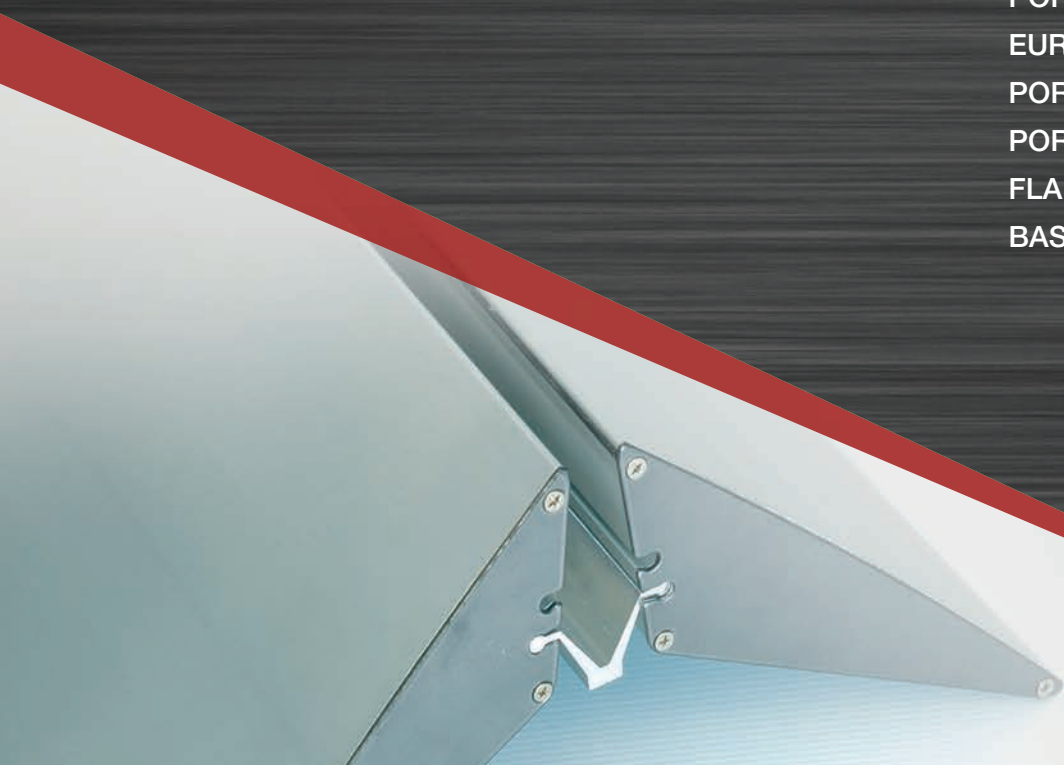

# INVISIBLE CLASSIC, QUADRO, & XXQUADRO

Coppia di supporti in Perspex trasparente, per pannelli leggeri (piuma, kapa, ecc.), da fissare nel mezzo tramite le apposite manopole; disponibile in sei diverse misure.

Pair of supports in transparent Perspex, for lightweight panels (feather, kapa, etc.), To be fixed in the middle through the appropriate knob; available in six different sizes.

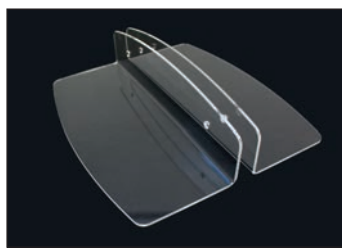

CLASSIC



QUADRO

## SCHEDA TECNICA INVISIBLE CLASSIC SPESS. MM 5

Codice art.	Descrizione	L.P.
EUINVI20	Coppia piedistalli in Perspex cm.20 + 2 kit manopole di serraggio	45
EUINVI25	Coppia piedistalli in Perspex cm.25 + 2 kit manopole di serraggio	60
EUINVI40	Coppia piedistalli in Perspex cm.40 + 2 kit manopole di serraggio	76
EUINVI50	Coppia piedistalli in Perspex cm.50 + 2 kit manopole di serraggio	97
EUINVI60	Coppia piedistalli in Perspex cm.60 + 2 kit manopole di serraggio	125
EUINVI75	Coppia piedistalli in Perspex cm.75 + 2 kit manopole di serraggio	150

## SCHEDA TECNICA INVISIBLE QUADRO SPESS. MM 6

Codice art.	Descrizione	L.P.
EUINVI25QU	Coppia piedistalli in Perspex cm.25 + 2 kit manopole di serraggio	65
EUINVI33QU	Coppia piedistalli in Perspex cm.33 + 2 kit manopole di serraggio	80
EUINVI40QU	Coppia piedistalli in Perspex cm.40 + 2 kit manopole di serraggio	90
EUINVI50QU	Coppia piedistalli in Perspex cm.50 + 2 kit manopole di serraggio	100
EUINVI60QU	Coppia piedistalli in Perspex cm.60 + 2 kit manopole di serraggio	120
EUINVI75QU	Coppia piedistalli in Perspex cm.75 + 2 kit manopole di serraggio	135

## SCHEDA TECNICA INVISIBLE XXQUADRO SPESS. MM 8

Codice art.	Descrizione	L.P.
EUINVI25XXQ	Coppia piedistalli in Perspex cm.25 + 2 kit manopole di serraggio	78
EUINVI33XXQ	Coppia piedistalli in Perspex cm.33 + 2 kit manopole di serraggio	90
EUINVI40XXQ	Coppia piedistalli in Perspex cm.40 + 2 kit manopole di serraggio	100
EUINVI50XXQ	Coppia piedistalli in Perspex cm.50 + 2 kit manopole di serraggio	115
EUINVI60XXQ	Coppia piedistalli in Perspex cm.60 + 2 kit manopole di serraggio	132
EUINVI75XXQ	Coppia piedistalli in Perspex cm.75 + 2 kit manopole di serraggio	150



# PIEDISTALLO TONDO

Base realizzata in Forex, Pvc o Perspex di forma circolare, bianca o nera, per sostenere pannelli di spessore mm. 10, 15 e 20 (kapa, piuma, ecc.). Disponibile in due diverse misure standard.

Base realized in Forex, PVC or Perspex circular in shape, white or black, to support panels of a thickness mm. 10, 15 and 20 (kapa, feath, etc.). Available in two standard sizes.

## SCHEDA TECNICA PIEDISTALLO TONDO 10 MM.

Codice art.	Descrizione	L.P.
EUPITOPX1050	Tondo in Perspex trasp. diam. cm.50 montato	160
EUPITOPX1038	Tondo in Perspex trasp. diam. cm.38 montato	104
EUPITOPVE1050	Tondo in Forex bianco diam. cm.50 montato	58
EUPITOPVE1038	Tondo in Forex bianco diam. cm.38 montato	41
EUPITOPVNE1050	Tondo in Forex nero diam. cm.50 montato	75
EUPITOPVNE1038	Tondo in Forex nero diam. cm.38 montato	52

## SCHEDA TECNICA PIEDISTALLO TONDO 15 MM.

Codice art.	Descrizione	L.P.
EUPITOPX1550	Tondo in Perspex trasp. diam. cm.50 montato	160
EUPITOPX1538	Tondo in Perspex trasp. diam. cm.38 montato	104
EUPITOPVE1550	Tondo in Forex bianco diam. cm.50 montato	58
EUPITOPVE1538	Tondo in Forex bianco diam. cm.38 montato	41
EUPITOPVNE1550	Tondo in Forex nero diam. cm.50 montato	75
EUPITOPVNE1538	Tondo in Forex nero diam. cm.38 montato	52

## SCHEDA TECNICA PIEDISTALLO TONDO 20 MM.

Codice art.	Descrizione	L.P.
EUPITOPX2050	Tondo in Perspex trasp. diam. cm.50 montato	160
EUPITOPX2038	Tondo in Perspex trasp. diam. cm.38 montato	104
EUPITOPVE2050	Tondo in Forex bianco diam. cm.50 montato	58
EUPITOPVE2038	Tondo in Forex bianco diam. cm.38 montato	41
EUPITOPVNE2050	Tondo in Forex nero diam. cm.50 montato	75
EUPITOPVNE2038	Tondo in Forex nero diam. cm.38 montato	52



FOREX



PERSPEX



# PIEDISTALLO ELLISSE

Base realizzata in Forex, Pvc o Perspex di forma ellittica, bianca o nera, per sostenere pannelli di spessore mm. 10, 15 e 20 (kapa, piuma, ecc.). Disponibile in due diverse misure standard.

Base in Forex, PVC or Perspex elliptical, white or black, to support panels of mm thick. 10, 15 and 20 (kapa, feather, etc.) Available in two standard sizes.

## SCHEDA TECNICA PIEDISTALLO ELLISSE 10 MM.

Codice art.	Descrizione	L.P.
EUIELPX105075	Ellisse in Perspex trasp. cm.50x75 montato	240
EUIELPX104060	Ellisse in Perspex trasp. cm.40x60 montato	160
EUIELPVE105075	Ellisse in Forex bianco cm.50x75 montato	81
EUIELPVE104060	Ellisse in Forex bianco cm.40x60 montato	58
EUIELPVNE105075	Ellisse in Forex nero cm.50x75 montato	104
EUIELPVNE104060	Ellisse in Forex nero cm.40x60 montato	81

## SCHEDA TECNICA PIEDISTALLO ELLISSE 15 MM.

Codice art.	Descrizione	L.P.
EUIELPX155075	Ellisse in Perspex trasp. cm.50x75 montato	240
EUIELPX154060	Ellisse in Perspex trasp. cm.40x60 montato	160
EUIELPVE155075	Ellisse in Forex bianco cm.50x75 montato	81
EUIELPVE154060	Ellisse in Forex bianco cm.40x60 montato	58
EUIELPVNE155075	Ellisse in Forex nero cm.50x75 montato	104
EUIELPVNE154060	Ellisse in Forex nero cm.40x60 montato	81

## SCHEDA TECNICA PIEDISTALLO ELLISSE 20 MM.

Codice art.	Descrizione	L.P.
EUIELPX205075	Ellisse in Perspex trasp. cm.50x75 montato	240
EUIELPX204060	Ellisse in Perspex trasp. cm.40x60 montato	160
EUIELPVE205075	Ellisse in Forex bianco cm.50x75 montato	81
EUIELPVE204060	Ellisse in Forex bianco cm.40x60 montato	58
EUIELPVNE205075	Ellisse in Forex nero cm.50x75 montato	104
EUIELPVNE204060	Ellisse in Forex nero cm.40x60 montato	81



FOREX



PERSPEX



# MAXI PIEDE

Struttura in plastica alveolare ultraleggera, con riquadri anteriori adesivi per il fissaggio di pannelli grafici. È disponibile in diverse altezze a scelta.

## MODALITA' DI MONTAGGIO

È sufficiente piegare le due ali sul retro ed incastrarle con l'apposito supporto anteriore da ripiegare. Successivamente si può fissare il pannello sul biadesivo anteriore (non riposizionabile).

*Lightweight plastic honeycomb structure, with adhesive front panels for attaching graphic panels. It is available in different heights to choose from.*

## ASSEMBLY MODALITY

*Simply fold the two wings on the back and fix them in place with the appropriate front support to fold. Then you can attach the front panel on the front tape (not repositionable)*



## SCHEDA TECNICA MAXIPIEDE ECONOMICO

Codice art.	Int.	Descrizione	L.P.
EUMAXPEC03	3HD	Maxipiede economico h. 30cm.	4
EUMAXPEC05	3HD	Maxipiede economico h. 50 cm.	7
EUMAXPEC07	5	Maxipiede economico h. 73 cm.	14
EUMAXPEC010	5	Maxipiede economico h. 100 cm.	21
EUMAXPEC015	5	Maxipiede economico h. 150 cm.	41

## SCHEDA TECNICA MAXIPIEDE SUPERECONOMICO

Codice art.	Int.	Descrizione	Confezione	L.P.
EUMAXSUP2	3	Maxipiede super economico h. 20 cm.	Pz.10	26
EUMAXSUP3	3	Maxipiede super economico h. 30cm.	Pz.10	29
EUMAXSUP5	3	Maxipiede super economico h. 50cm	Pz.10	58
EUMAXSUP7	3HD	Maxipiede super economico h. 73 cm.	Pz.10	92
EUMAXSUP10	3HD	Maxipiede super economico h. 100 cm.	Pz.10	138

# PORTAPANNELLI WING

Portapannelli in alluminio e metallo, colore grigio, posizionabile in due diverse modalità per pannelli di vari spessori che è possibile fissare tramite l'apposita manopola. Disponibile in tre diverse dimensioni.

*Aluminum and metal board supporting, grey, you can place it in two different ways for panels of various thicknesses that can be fixed by the appropriate knob. Available in three different sizes.*

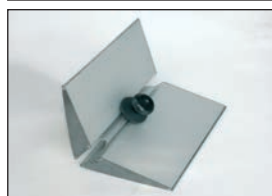
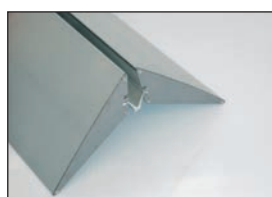
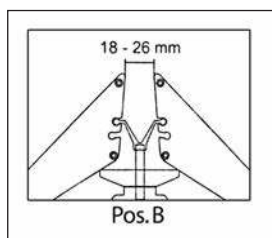
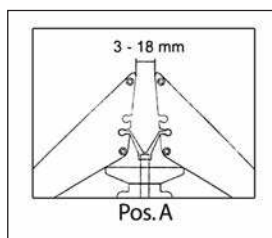

## SCHEDA TECNICA

Codice art.	Larghezza piede cm.	Misura cm.	Peso Kg.	L.P.
RBWING10	10	40x15x15	1.8	60
RBWING35	35	40x36x15	4.5	125
RBWING50	50	40x51x15	6	160

# EUROPIEDE

Portapannelli in Pvc-hd grigio chiaro o scuro ed in Perspex trasparente, per il sostegno di pannelli sandwich fino a cm. 200x300 e spessore cm. 3. Disponibile nei seguenti formati standard.

*Pvc-hd support dark grey or light grey or transparent Perspex, capable of supporting sandwich panels up to cm. 200x300 in height, and thickness cm. 3. Available in the following standard formats.*

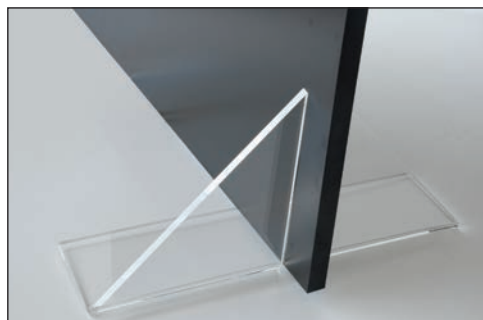
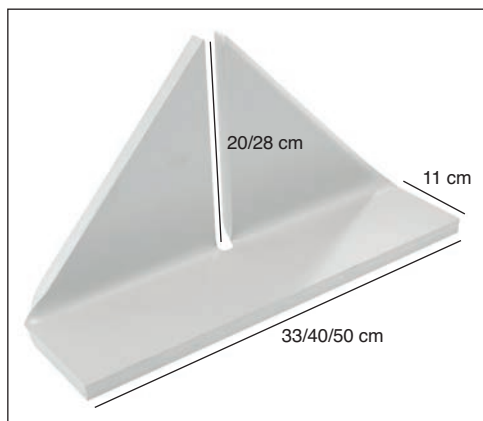

DIMENSIONE MAX PANNELLO CM 300



## SCHEDA TECNICA

Codice art.	Descrizione	Spessore pannello mm.	Altezza max pannello cm.	L.P.
EUEUPIX3310	Coppia Europiede Perspex trasparente cm. 33	10	150/160	50
EUEUPIX3315	Coppia Europiede Perspex trasparente cm. 33	15	150/160	50
EUEUPIX3320	Coppia Europiede Perspex trasparente cm. 33	20	150/160	50
EUEUPIX4015	Coppia Europiede Perspex trasparente cm. 40	15	200	80
EUEUPIX4020	Coppia Europiede Perspex trasparente cm. 40	20	200	80
EUEUPIX5020	Coppia Europiede Perspex trasparente cm. 50	20	250	125
EUEUPIX5030	Coppia Europiede Perspex trasparente cm. 50	30	300	125
EUEUPIPVC3310	Coppia Europiede PVC-HD grigio chiaro cm. 33	10	150/160	50
EUEUPIPVC3315	Coppia Europiede PVC-HD grigio chiaro cm. 33	15	150/160	50
EUEUPIPVC3320	Coppia Europiede PVC-HD grigio chiaro cm. 33	20	150/160	50
EUEUPIPVC4015	Coppia Europiede PVC-HD grigio chiaro cm. 40	15	200	80
EUEUPIPVC4020	Coppia Europiede PVC-HD grigio chiaro cm. 40	20	200	80
EUEUPIPVC5020	Coppia Europiede PVC-HD grigio chiaro cm. 50	20	250	125
EUEUPIPVC5030	Coppia Europiede PVC-HD grigio chiaro cm. 50	30	300	125



# PORTAPANNELLI FRECCIA

Portapannelli in polionda bianco, spessore mm. 5, con appositi alloggiamenti per il fissaggio di pannelli da cm. 70x100 e cm. 100x140 (non compresi).

*Panels supporting in white corrugated material, thickness mm. 5, with the slots for the fixing of panels from cm. 70x100 cm. and 100x140 (not included).*

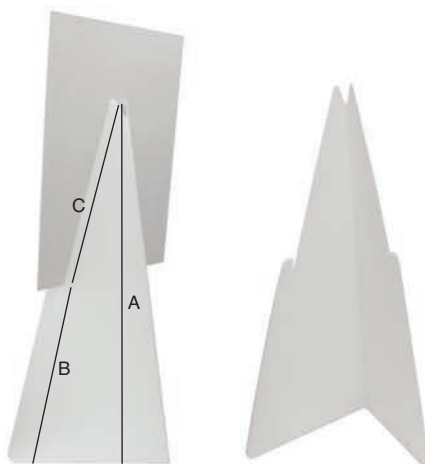

## SCHEDA TECNICA

Codice art.	Pannello cm.	Dimensioni struttura cm.			L.P.
		A	B	C	
<b>EUPOFRE710</b>	70x100	142	72	73	66
<b>EUPOFRE1014</b>	100x140	156	57	104	66

# PORTAPANNELLI PERSPEX

Sistema di sostegno in Perspex trasparente, per pannelli di dimensioni massime cm. 70x100, e spessore da mm. 5 a mm. 20. Sono disponibili in due varianti, una triangolare l'altra a mezzaluna, in diverse misure standard.

*Support system in transparent Perspex, for panels of maximum dimensions cm. 70x100, and a thickness from mm. 5 to mm. 20. They are available in two variants, the one triangular the other half-moon, in different standard sizes.*

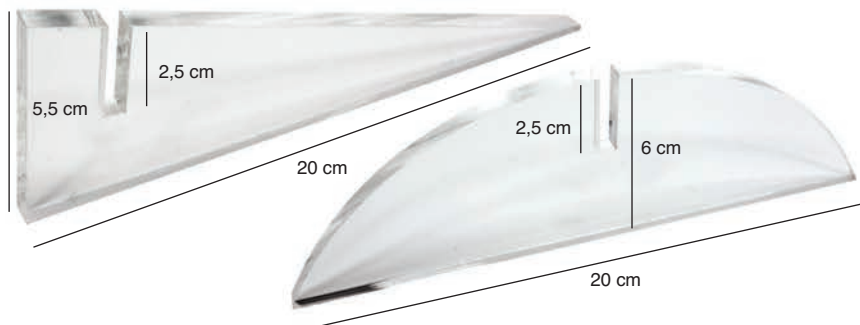

## SCHEDA TECNICA

Codice art.	Descrizione	Spessore pannello mm.	L.P.
<b>EUPPMZ5</b>	Portapannelli a mezzaluna (10 pz.)	5	70
<b>EUPPMZ10</b>	Portapannelli a mezzaluna (10 pz.)	10	70
<b>EUPPMZ15</b>	Portapannelli a mezzaluna (10 pz.)	15	70
<b>EUPPMZ20</b>	Portapannelli a mezzaluna (10 pz.)	20	70
<b>EUPPTR5</b>	Portapannelli triangolare (10 pz.)	5	70
<b>EUPPTR10</b>	Portapannelli triangolare (10 pz.)	10	70
<b>EUPPTR15</b>	Portapannelli triangolare (10 pz.)	15	70
<b>EUPPTR20</b>	Portapannelli triangolare (10 pz.)	20	70



# FLAP

Soluzione espositiva bifacciale in alluminio anodizzato, per appendere al muro pannelli rigidi di spessore mm. 5 e mm. 6, altezza massima cm. 150, larghezza massima cm 60. PANNELLO NON COMPRESO.

*Bi-side expository anodized aluminum solution, to hang on the wall rigid panels mm 5 and mm 6 thick, maximum height cm. 150, maximum width 60 cm. PANEL NOT INCLUDED.*

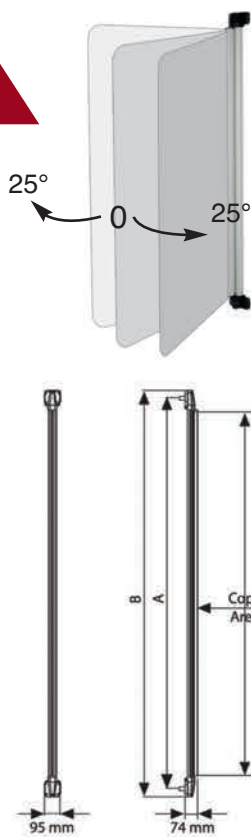

## SCHEDA TECNICA

Codice art.	Pannello cm.	Misura cm.	Imballo cm.	Peso Kg.	L.P.
MTFLAP100	62x100	112	11x117x9,5	4,6	80
MTFLAP120	62x120	132	11x37x9,5	5,5	90
MTFLAP150	62x150	162	11x16,7x9,5	6,7	106

# BASE PLAST

Base in plastica antiurto, colore nero, riempibile con acqua o sabbia per garantirne un'alta stabilità. È incluso il paletto in alluminio con apposito innesto per il fissaggio di pannelli promozionali, di lunghezza cm. 200.

*Shock absorbent plastic base, black, to be filled with water or sand to ensure high stability. It is included the aluminum pole with special clutch for the attachment of promotional panels, length cm. 200.*



## SCHEDA TECNICA

Codice art.	Misura cm.	Asta ø cm.	Peso Kg.	L.P.
EUFLBAPLA	52x52x21	2.2	2	62



# DESK - BANCHETTI

NEW PROMOSTAND  
PROMOLUNA  
NEW ALUXBANCO  
ALUXBANCO PLUS  
ECODESK  
PROMODESK  
POP DESK  
POP ARCO  
ONDATALE  
ONDATALE TONDO  
US DESK

# NEW PROMOSTAND

Desk autoportante in materiale plastico, con testata e base personalizzabili con grafiche. Sacca per il trasporto inclusa.

*Desk-standing plastic, with headboard and base customized with graphics. Sack for the transportation included.*

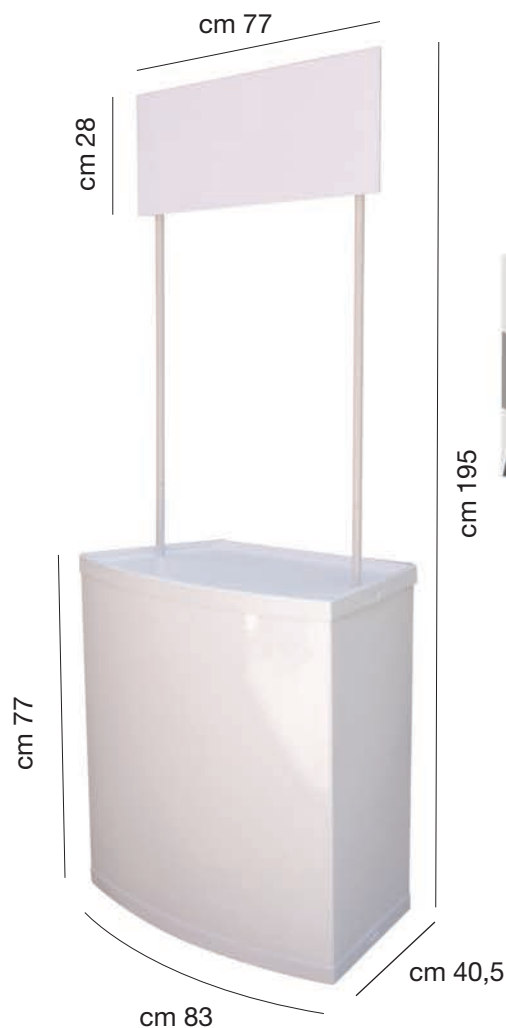

## SCHEMA TECNICA

Codice art.	Descrizione	Misure cm.	Grafica frontale cm.	Grafica laterale cm.	L.P.
DWNEWPRO	New Promostand con sacca	195x83x40.5	83x77	40.5x77	180



# PROMOLUNA

Desk autoportante in materiale plastico, con testata e base personalizzabili con grafiche. Altezza totale cm. 205, sacca per il trasporto inclusa nel prezzo.

*Plastic self-supporting desk, with customizable header and base. Total height cm. 205, transport bag included with the price.*



## SCHEMA TECNICA

Codice art.	Grafica sup. cm.	Grafica inf. cm	Peso Kg.	Imballo cm.	L.P.
DWPROLU	77x28	123x85	6,5	88,5x86x11	180

# NEW ALUXBANCO

Desk con struttura portante in alluminio anodizzato argento, e pannelli in Pvc espanso decorabili, fornito già assemblato. Optional la sacca per il trasporto.

*Desk with a structure in silver anodized aluminum and PVC foam panels can be decorated, supplied already assembled. The carrying bag is optional.*

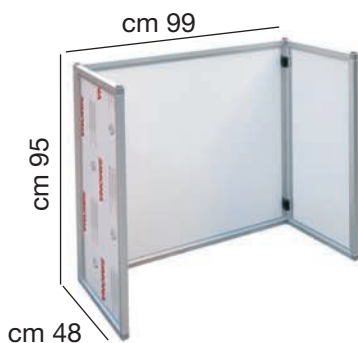

## SCHEMA TECNICA

Codice art.	Descrizione	Misure cm.	Grafica frontale cm.	Grafica laterale cm.	Peso Kg.	L.P.
EUNEWALUBA	Banco in alluminio e PVC	100x95x48	90.5x86.5	37.5x86.5	14	400
SNSACCA	Sacca in tessuto (optional)					50

# ALUXBANCO PLUS

Desk con telaio in alluminio anodizzato silver, pannelli in Pvc bianco spessore mm. 5 fissati all'esterno del profilo e pianale in Perspex nero. Disponibile in 4 misure standard, optional la sacca per il trasporto.

*Desk with silver anodized aluminum frame, white Pvc panel thickness mm. 5 fixed to the outside of the profile and black Perspex top. Available in 4 standard sizes, carrying bag optional.*

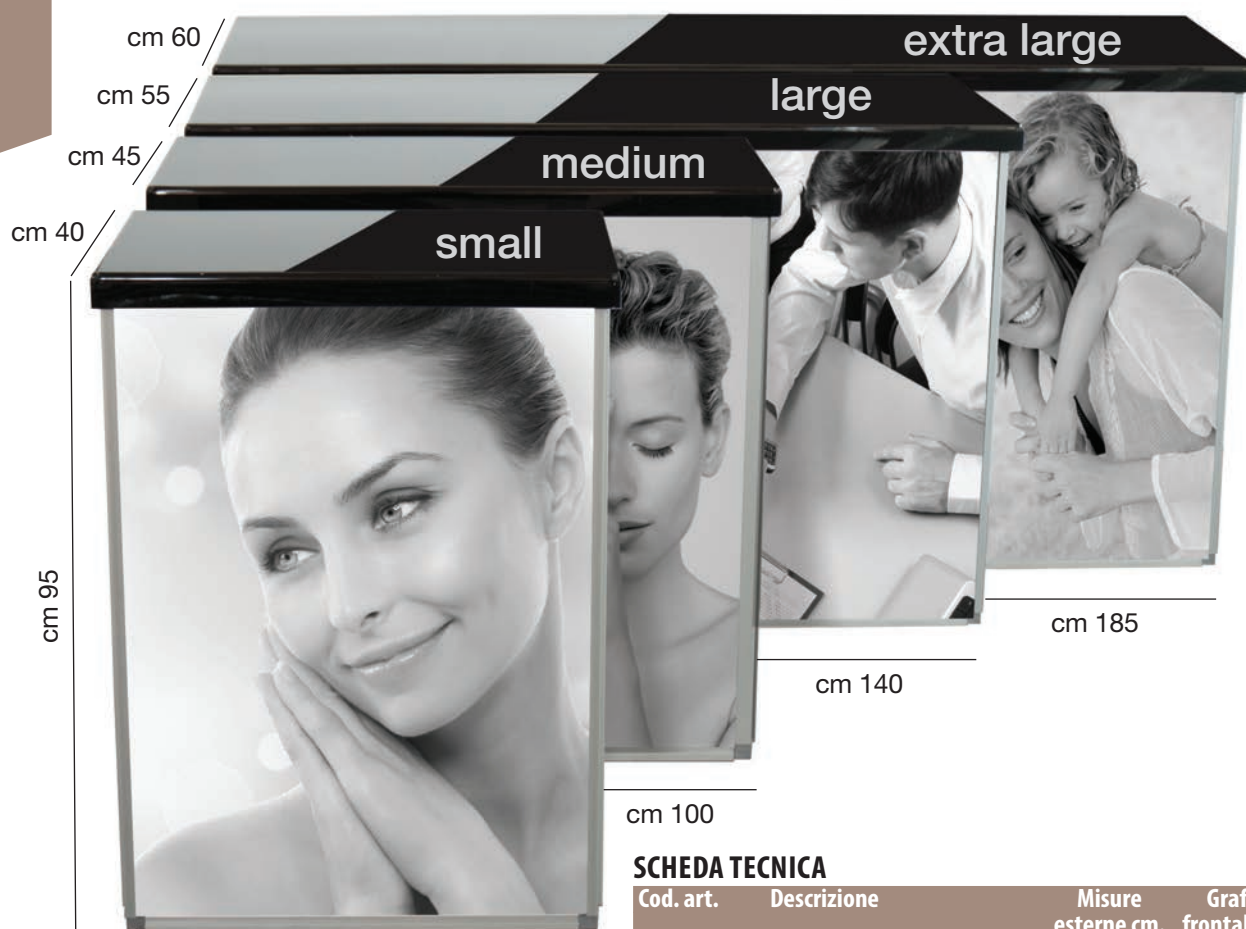
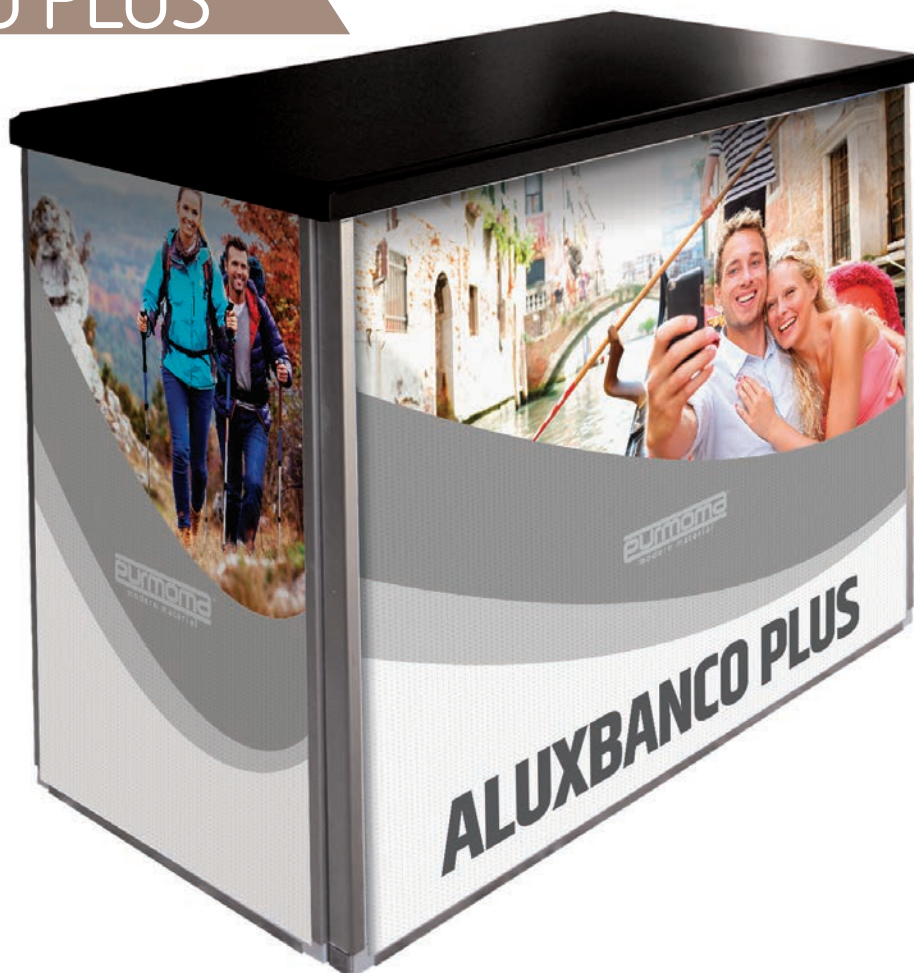

cm 65

## SCHEMA TECNICA

Cod. art.	Descrizione	Misure esterne cm.	Grafica frontale cm.	Grafica laterale cm.	L.P.
EVALUBASNE	Aluxbanco Plus Small piano nero	65x95x40	63x94	94x35,5	280
EVALUBAMNE	Aluxbanco Plus Medium piano nero	100x95x45	100x94	94x40,5	350
EVALUBALNE	Aluxbanco Plus Large piano nero	140x95x55	138x94	94x51	450
EVALUBAELNE	Aluxbanco Plus Extra Large piano nero	185x95x60	183x94	94x56,5	650

# ECODESK

Desk in polionda bianco, spessore mm. 5, facile montaggio grazie alle pre-incisioni, stampabile in digitale o con plotter da intaglio.

Desk in white corrugated material, thickness mm. 5, easy installation due to pre-incisions, printable digital or plotters.

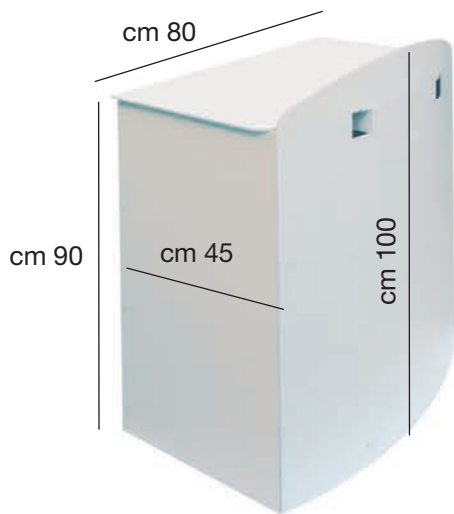

## SCHEMA TECNICA

Codice art.	Descrizione	Misure cm.	Grafica frontale cm.	Grafica laterale cm.	L.P.
<b>EUICODESK</b>	Banco componibile in polionda bianco	80x100x45	95x85	45x85	115

# PROMODESK

Desk composto da top superiore ed inferiore in legno, e pannello grafico flessibile fissato alla struttura portante tramite velcro.

Desk composed of upper and lower top in wood, and flexible graphical panel fixed to the supporting structure with Velcro.



cm 93  
cm 42



cm 82

## SCHEMA TECNICA

Codice art.	Misure cm.	Grafica cm.	Peso Kg.	L.P.
<b>DWPRODESK</b>	82x93x42	90x172	13	250

# POP DESK

cm 150

Desk con struttura tubolare a ragno in alluminio anodizzato, ripiano in legno e pannelli in banner Pvc da applicare al telaio tramite velcro adesivo cucito, con grafica utile cm. 224 x 88.5. Sacche per il trasporto include.

*Desk with tubular spider anodized aluminum, wooden shelf panels and PVC banners to be applied to the frame with velcro tape sewn, with graphics useful cm. 224 x 88.5 Carrying bags included.*



cm 92



cm 40

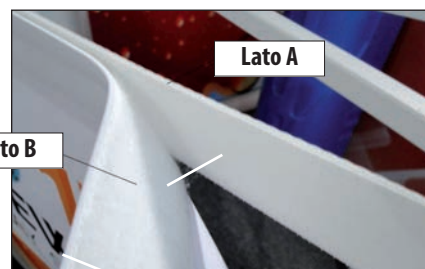

## SCHEMA TECNICA

Codice art.	Misure cm.	Grafica cm.	L.P.
DWPOPEDESK	150x92x40	224x88.5	280

# POP ARCO

Desk con struttura a ragno richiudibile, realizzata in alluminio, top in legno; il supporto per la grafica è in PVC di dimensioni cm.94,5x196,6 e si applica alla struttura mediante magnetico adesivo.

*Resealable desk with spider structure, realized in aluminum with wood top; the graphic support in PVC size cm. 94,5x196,6 is fixed to the structure through magnetic adhesive.*



## SCHEMA TECNICA

Codice art.	Misure cm.	Grafica cm.	L.P.
DWPOPARCO	126x95x35	94,5x196,6	280

# ONDATABLE

Desk con top in Pvc espanso nero di spessore mm.10, e struttura in polionda bianco di spessore mm. 5. Disponibile in un'unica misura, sacca per il trasporto non inclusa.

*Desk top with black PVC foam thickness 10 mm, and structure in white corrugated material thickness mm. 5. Available in one size, carrying bag not included.*

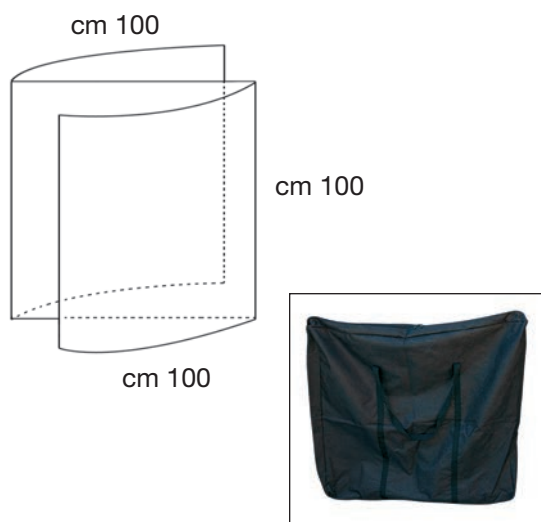

## SCHEDA TECNICA

Codice art.	Descrizione	L.P.
EUOT1010	Tavolo in polionda forma ovale	173
SNSACCA	Sacca in tessuto XL	50



# ONDATABLE TONDO

Desk con struttura portante tonda di diametro cm. 67 in polionda bianco di spessore mm. 5, e ripiano in Pvc espanso nero di spessore mm. 10. Sacca per il trasporto non inclusa.

*Desk with supporting structure of round diameter cm. 67 mm thick white corrugated material. 5, and PVC foam -topped black mm thick. 10. Carrying bag not included.*

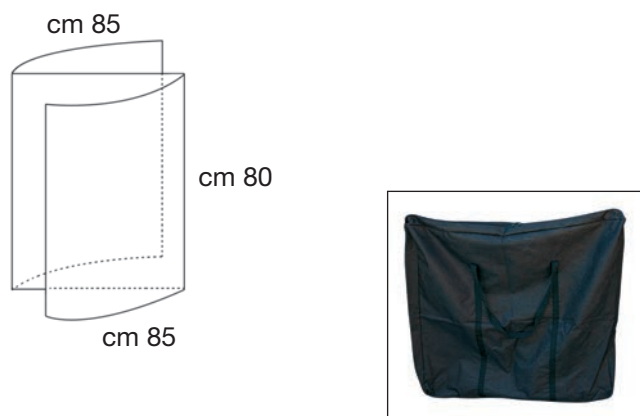

## SCHEDA TECNICA

Codice art.	Descrizione	Misure cm.	L.P.
EUOTT8085	Tavolo polionda tondo	Ø 67	173
SNSACCA	Sacca in tessuto XL		50



# US DESK



Desk con struttura in alluminio silver, altezza cm. 90, base e ripiano in PVC espanso grigio scuro antigraffio spessore mm. 19. Disponibile in due grandezze, Standard e XL.

Desk with aluminum silver structure, height cm. 90, base and shelf in anti-scratch PVC foam dark silver thickness mm. 19. Available in two sizes, Standard and XL.

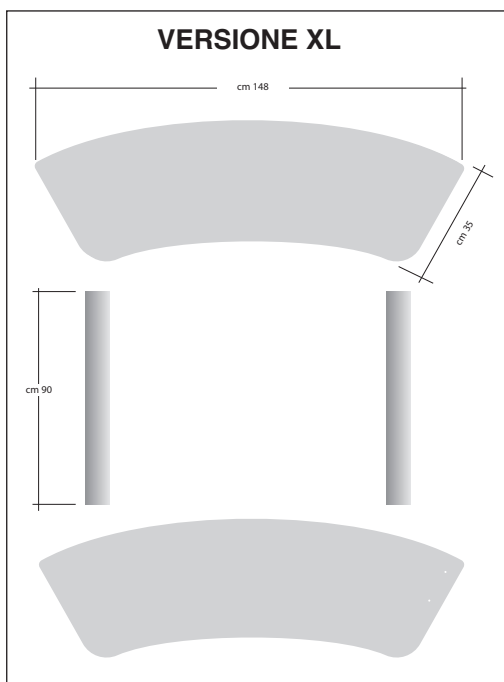
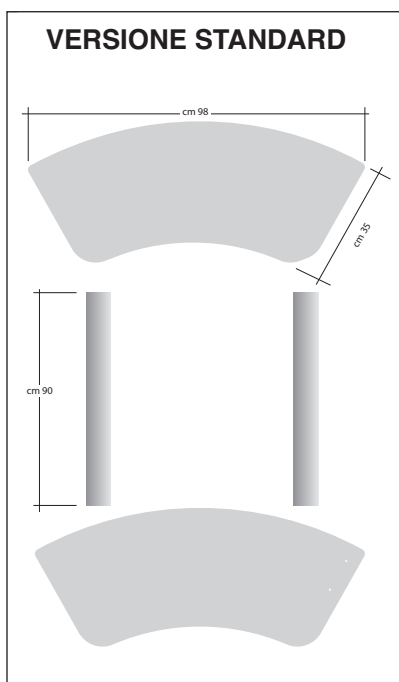

## SCHEMA TECNICA

Codice art.	Descrizione	L.P.
EUUSDESK	Desk cm.98x35x90	300
EUUSDESKXXL	Desk XL cm. 148x35x90	400
SNSACCA	Sacca in tessuto XL	50



# LASTRE, PROFILI, ACCESSORI E LED

LASTRE PIUMA  
FOGLI PVC-PP-PET-PST  
LASTRE PVC ESPANSO  
LASTRE POLIONDA  
LASTRE METACRILATO  
LASTRE KARTOON  
LASTRE EUROBOND  
SUPPORTI DA PARATI DIGITALI  
CARTA TRANSFER PER STAMPANTI LASER  
SUPPORTI LASER PRE-FUSTELLATI  
BIADESIVI  
APPENDINI  
GANCIO E UNCINO  
PROFILI ALU E PLAST  
PROFILI TECHNO  
QUADROTRATTO  
CASSONETTI LED  
PUNTE PER FRESE CNC  
LETTERE A SPECCHIO  
PANNELLI RASTERIZZATI  
LETTERE IN PVC ESPANSO  
LETTERE PER RETROILLUMINAZIONE

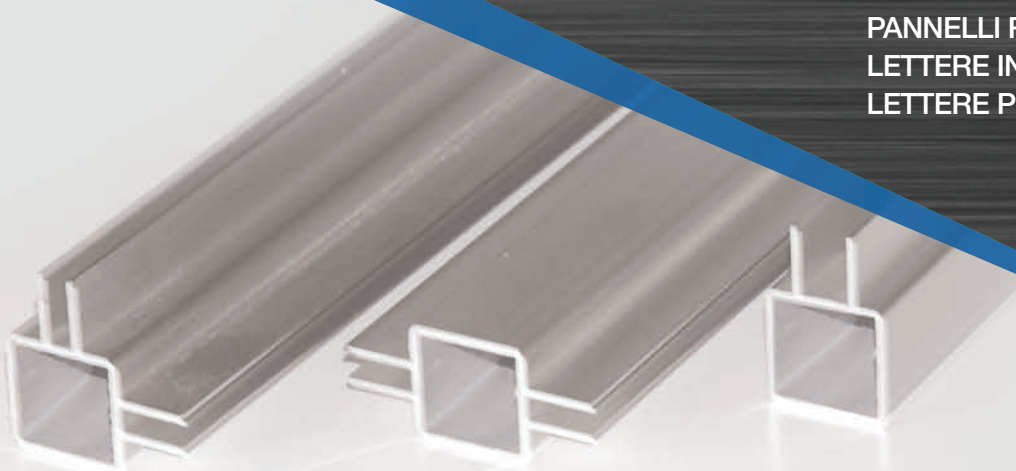

Pannello sandwich con superficie in PVC ed interno espanso, molto rigido ma leggero allo stesso tempo. È indicato per laminare stampe digitali, scritte prespaziate e per la serigrafia. Disponibile sia semplice che bordato in diverse finiture, si può avere in diversi formati e spessori a scelta.

*Sandwich panel with PVC surface and interior foam, very rigid but light at the same time. It is suitable for laminating digital prints, pre-spaced written for the silk-screen printing. Available both simple and with border in different finishes, you can have different sizes and thicknesses to choose.*



## LASTRA PIUMA BIANCO SPESSORE 10 MM

Codice art.	Dim. pannello		Pezzi per confezione	L.P.
	H.cm	L.cm.		
EULP1057BB	50	70	16	149
EULP10710BB	70	100	8	149
EULP101014BB	100	140	4	149
EULP101015BB	100	150	4	149
EULP101010BB	100	100	6	149
EULP105020BB	50	200	6	149
EULP107520BB	75	200	4	149
EULP101020BB	100	200	3	149
EULP101520BB	150	200	2	149

## LASTRA PIUMA BIANCO SPESSORE 15 MM

Codice art.	Dim. pannello		Pezzi per confezione	L.P.
	H.cm	L.cm.		
EULP1557BB	50	70	16	168
EULP15710BB	70	100	8	168
EULP151014BB	100	140	4	168
EULP151015BB	100	150	4	168
EULP151010BB	100	100	6	168
EULP155020BB	50	200	6	168
EULP157520BB	75	200	4	168
EULP151020BB	100	200	3	168
EULP151520BB	150	200	2	168

## LASTRA PIUMA BIANCO SPESSORE 20 MM

Codice art.	Dim. pannello		Pezzi per confezione	L.P.
	H.cm	L.cm.		
EULP2057BB	50	70	16	180
EULP20710BB	70	100	8	180
EULP201014BB	100	140	4	180
EULP201015BB	100	150	4	180
EULP201010BB	100	100	6	180
EULP205020BB	50	200	6	180
EULP207520BB	75	200	4	180
EULP201020BB	100	200	3	180
EULP201520BB	150	200	2	180

## LASTRA PIUMA BIANCO SPESSORE 30 MM

Codice art.	Dim. pannello		Pezzi per confezione	L.P.
	H.cm	L.cm.		
EULP3057BB	50	70	16	274
EULP30710BB	70	100	8	274
EULP301014BB	100	140	4	274
EULP301015BB	100	150	4	274
EULP301010BB	100	100	6	274
EULP305020BB	50	200	6	274
EULP307520BB	75	200	4	274
EULP301020BB	100	200	3	274
EULP301520BB	150	200	2	274

## LASTRA PIUMA BIANCO SPESSORE 40 MM

Codice art.	Dim. pannello		Pezzi per confezione	L.P.
	H.cm	L.cm.		
EULP4057BB	50	70	16	304
EULP40710BB	70	100	8	304
EULP401014BB	100	140	4	304
EULP401015BB	100	150	4	304
EULP401010BB	100	100	6	304
EULP405020BB	50	200	6	304
EULP407520BB	75	200	4	304
EULP401020BB	100	200	3	304
EULP401520BB	150	200	2	304

## LASTRA PIUMA BIANCO SPESSORE 50 MM

Codice art.	Dim. pannello		Pezzi per confezione	L.P.
	H.cm	L.cm.		
EULP5057BB	50	70	16	348
EULP50710BB	70	100	8	348
EULP501014BB	100	140	4	348
EULP501015BB	100	150	4	348
EULP501010BB	100	100	6	348
EULP505020BB	50	200	6	348
EULP507520BB	75	200	4	348
EULP501020BB	100	200	3	348
EULP501520BB	150	200	2	348

## LASTRA PIUMA BIANCO SPESSORE 60 MM

Codice art.	Dim. pannello		Pezzi per confezione	L.P.
	H.cm	L.cm.		
EULP6057BB	50	70	16	404
EULP60710BB	70	100	8	404
EULP601014BB	100	140	4	404
EULP601015BB	100	150	4	404
EULP601010BB	100	100	6	404
EULP605020BB	50	200	6	404
EULP607520BB	75	200	4	404
EULP601020BB	100	200	3	404
EULP601520BB	150	200	2	404





## LA STRA PIUMA NERO-NUCLEO NERO SPESSORE 10 MM.

Codice art.	Dim. pannello		Pezzi per confezione	L.P.
	H.cm	L.cm.		
EULP1057NN	50	70	16	192
EULP10710NN	70	100	8	192
EULP101014NN	100	140	4	192
EULP101015NN	100	150	4	192
EULP101010NN	100	100	6	192
EULP105020NN	50	200	6	192
EULP107520NN	75	200	4	192
EULP101020NN	100	200	3	192
EULP101520NN	150	200	2	192

## LA STRA PIUMA NERO-NUCLEO NERO SPESSORE 15 MM.

Codice art.	Dim. pannello		Pezzi per confezione	L.P.
	H.cm	L.cm.		
EULP1557NN	50	70	16	210
EULP15710NN	70	100	8	210
EULP151014NN	100	140	4	210
EULP151015NN	100	150	4	210
EULP151010NN	100	100	6	210
EULP155020NN	50	200	6	210
EULP157520NN	75	200	4	210
EULP151020NN	100	200	3	210
EULP151520NN	150	200	2	210

## LA STRA PIUMA NERO-NUCLEO NERO SPESSORE 20 MM.

Codice art.	Dim. pannello		Pezzi per confezione	L.P.
	H.cm	L.cm.		
EULP2057NN	50	70	16	220
EULP20710NN	70	100	8	220
EULP201014NN	100	140	4	220
EULP201015NN	100	150	4	220
EULP201010NN	100	100	6	220
EULP205020NN	50	200	6	220
EULP207520NN	75	200	4	220
EULP201020NN	100	200	3	220
EULP201520NN	150	200	2	220

## LA STRA PIUMA NERO-NUCLEO NERO SPESSORE 30 MM.

Codice art.	Dim. pannello		Pezzi per confezione	L.P.
	H.cm	L.cm.		
EULP2057NN	50	70	16	322
EULP20710NN	70	100	8	322
EULP201014NN	100	140	4	322
EULP201015NN	100	150	4	322
EULP201010NN	100	100	6	322
EULP205020NN	50	200	6	322
EULP207520NN	75	200	4	322
EULP201020NN	100	200	3	322
EULP201520NN	150	200	2	322

## LA STRA PIUMA NERO-NUCLEO BIANCO SPESSORE 10 MM.

Codice art.	Dim. pannello		Pezzi per confezione	L.P.
	H.cm	L.cm.		
EULP1057NB	50	70	16	170
EULP10710NB	70	100	8	170
EULP101014NB	100	140	4	170
EULP101015NB	100	150	4	170
EULP101010NB	100	100	6	170
EULP105020NB	50	200	6	170
EULP107520NB	75	200	4	170
EULP101020NB	100	200	3	170
EULP101520NB	150	200	2	170

## LA STRA PIUMA NERO-NUCLEO BIANCO SPESSORE 15 MM.

Codice art.	Dim. pannello		Pezzi per confezione	L.P.
	H.cm	L.cm.		
EULP1557NB	50	70	16	188
EULP15710NB	70	100	8	188
EULP151014NB	100	140	4	188
EULP151015NB	100	150	4	188
EULP151010NB	100	100	6	188
EULP155020NB	50	200	6	188
EULP157520NB	75	200	4	188
EULP151020NB	100	200	3	188
EULP151520NB	150	200	2	188

## LA STRA PIUMA NERO-NUCLEO BIANCO SPESSORE 20 MM.

Codice art.	Dim. pannello		Pezzi per confezione	L.P.
	H.cm	L.cm.		
EULP2057NB	50	70	16	198
EULP20710NB	70	100	8	198
EULP201014NB	100	140	4	198
EULP201015NB	100	150	4	198
EULP201010NB	100	100	6	198
EULP205020NB	50	200	6	198
EULP207520NB	75	200	4	198
EULP201020NB	100	200	3	198
EULP201520NB	150	200	2	198

## LA STRA PIUMA NERO-NUCLEO BIANCO SPESSORE 30 MM.

Codice art.	Dim. pannello		Pezzi per confezione	L.P.
	H.cm	L.cm.		
EULP3057NB	50	70	16	298
EULP30710NB	70	100	8	298
EULP301014NB	100	140	4	298
EULP301015NB	100	150	4	298
EULP301010NB	100	100	6	298
EULP305020NB	50	200	6	298
EULP307520NB	75	200	4	298
EULP301020NB	100	200	3	298
EULP301520NB	150	200	2	298

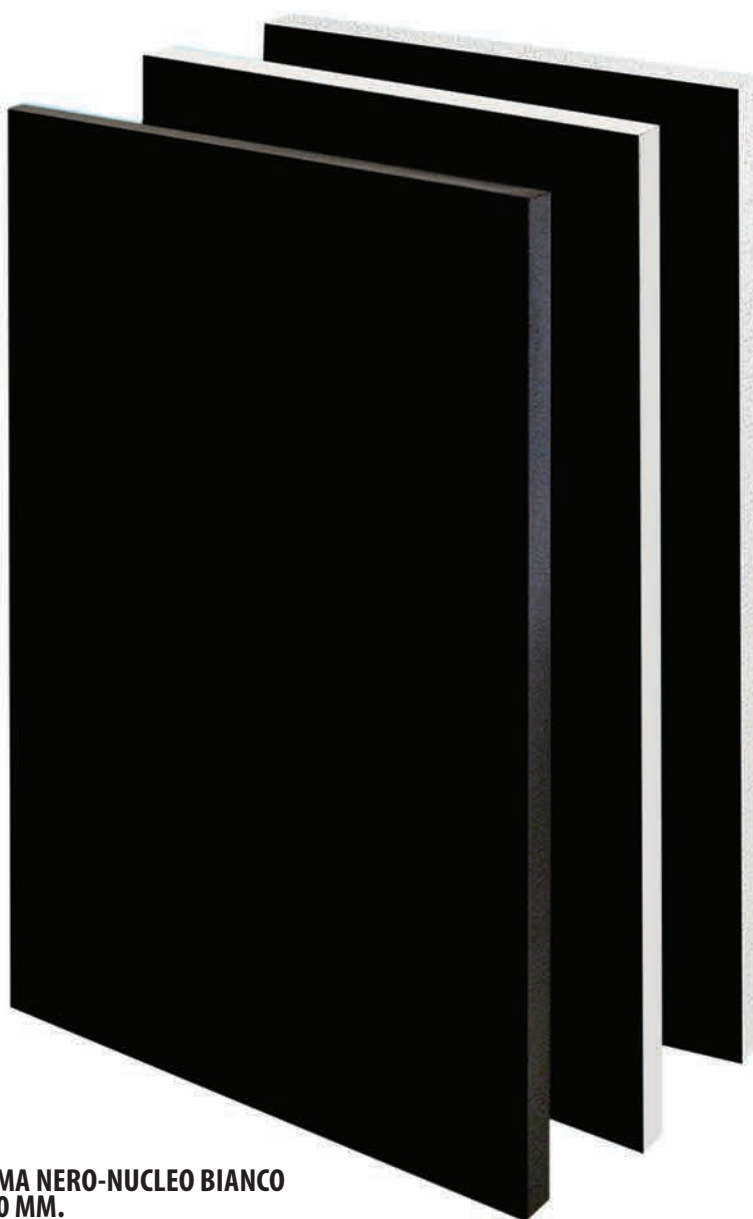

# FOGLI PVC - PP - PET - PST



## SCHEDA TECNICA FOGLI PVC CM.70X100

Codice art.	Dim. pannello	UM	L.P.
KKPVN15710	trasp.bilucido 150my	ff	1,30
KKPVN20710	trasp.bilucido 200my	ff	1,80
KKPVN30710	trasp.bilucido 300my	ff	2,70
KKPVN50710	trasp.bilucido 500my	ff	4,40
KKPVN70710	trasp.bilucido 700my	ff	6,10
KKPVB20710	bianco bilucido 200my	ff	1,90
KKPVB30710	bianco bilucido 300my	ff	2,80
KKPVB50710	bianco bilucido 500my	ff	4,60
KKPVB70710	bianco bilucido 700my	ff	6,50
KKPVB90710	bianco bilucido 900my	ff	8,20
KKSAT20710	bianco opaco 200my	ff	1,90
KKSAT30710	bianco opaco 300my	ff	2,80
KKSAT50710	bianco opaco 500my	ff	4,70
KKSAT70710	bianco opaco 700my	ff	6,60
KKPVM20710	trasp.luc/goffr 200my	ff	2,00
KKPVM30710	trasp.luc/goffr 300my	ff	3,00
KKPVM50710	trasp.luc/goffr 500my	ff	4,80
KKPVM70710	trasp.luc/goffr 700my	ff	6,90
KKSP200710	bianco opaco copr. 200my	ff	2,10

## SCHEDA TECNICA FOGLI PVC CM.100X140

Codice art.	Dim. pannello	UM	L.P.
KKPVM501014	trasp.luc/goffr 500my	ff	9,60

## SCHEDA TECNICA CARTA SILICONATA

Codice art.	Dim. pannello	UM	L.P.
MACS120	carta siliconata 120gr	ff	1,00

## SCHEDA TECNICA FOGLI POLIPROPILENE CM.70X100

Codice art.	Dim. pannello	UM	L.P.
OPPPN30710	neutro matt/quarz 300my	ff	2,10
OPPPN40710	neutro matt/quarz 400my	ff	2,10
OPPPN50710	neutro matt/quarz 500my	ff	2,60
OPPPN70710	neutro matt/quarz 700my	ff	3,60
OPPPN00710	neutro matt/quarz 1000my	ff	5,10
OPPPB30710	bianco matt/quarz 300my	ff	2,10
OPPPB40710	bianco matt/quarz 400my	ff	2,10
OPPPB50710	bianco matt/quarz 500my	ff	2,60
OPPPB70710	bianco matt/quarz 700my	ff	3,60
OPPPB00710	bianco matt/quarz 1000my	ff	5,10
OPPPPT50710	trasp.bilucido 500my	ff	2,80
OPPPPT70710	trasp.bilucido 700my	ff	3,90
OPPPZ50710	nero matt/quarz 500my	ff	2,80
OPPPZ70710	nero matt/quarz 700my	ff	3,90

## SCHEDA TECNICA FOGLI POLISTIRENE CM.100X200

Codice art.	Dim. pannello	UM	L.P.
RLSPS101020	specchio argento sp.mm.1	ff	52,00
RLPSB10M1020	bianco matt/lucido sp.mm.1	ff	19,50
RLPSB15M1020	bianco matt/lucido sp.mm.1,5	ff	28,90
RLPSB20M1020	bianco matt/lucido sp.mm.2	ff	38,50

## SCHEDA TECNICA FOGLI PVC INTEGRALE CM.100X200

Codice art.	Dim. pannello	UM	L.P.
SMMZB101020	bianco lucido 656 mm.1	ff	26,90
SMMZB151020	bianco lucido 656 mm.1,5	ff	40,50
SMMZB201020	bianco lucido 656 mm.2	ff	53,70
SMMZB301020	bianco lucido 656 mm.3	ff	80,70
SMMZZ101020	nero lucido 666 mm.1	ff	26,90
SMMZZ201020	nero lucido 666 mm.2	ff	53,70
SMMZZ301020	nero lucido 666 mm.3	ff	80,70
SMMZG101020	giallo lucido 667 mm.1	ff	30,40
SMMZG201020	giallo lucido 667 mm.2	ff	60,70
SMMZG301020	giallo lucido 667 mm.3	ff	91,10
SMMZU201020	blu lucido 671 mm.2	ff	60,70
SMMZU301020	blu lucido 671 mm.3	ff	91,10
SMMZR201020	rosso lucido 671 mm.2	ff	60,70
SMMZR301020	rosso lucido 671 mm.3	ff	91,10
SMMZW201020	grigio lucido 9310 mm.2	ff	53,70
SMMZW301020	grigio lucido 9310 mm.3	ff	80,70

## SCHEDA TECNICA FOGLI PET CM.70X100

Codice art.	Dim. pannello	UM	L.P.
NDPETGAG30710	pet gag trasparente 300my	ff	2,50
NDPETGAG50710	pet gag trasparente 500my	ff	4,00

## SCHEDA TECNICA FOGLI PET CM.125X205

Codice art.	Dim. pannello	UM	L.P.
NDPET0005	pet trasparente bi-protetto 500my	ff	16,90
NDPET0007	pet trasparente bi-protetto 700my	ff	21,76
NDPETAR07	pet antiriflesso bi-protetto 700my	ff	23,00
NDPETAR10	pet antiriflesso bi-protetto mm.1	ff	31,23
NDPETAR15	pet antiriflesso bi-protetto mm.1,5	ff	46,08
NDPETG05	petg trasparente bi-protetto 500my	ff	20,74
NDPETG07	petg trasparente bi-protetto 700my	ff	27,39

## SCHEDA TECNICA FOGLI PET CM.203X305

Codice art.	Dim. pannello	UM	L.P.
NDPET0010	pet trasparente bi-protetto mm.1	ff	78,13
NDPET0015	pet trasparente bi-protetto mm.1,5	ff	105,63
NDPETG10	petg trasparente bi-protetto mm.1	ff	86,25
NDPETG15	petg trasparente bi-protetto mm.1,5	ff	122,50

# LASTRE PVC ESPANSO

## SIMONA

Lastre viniliche con struttura cellulare omogenea, superficie compatta, finitura satinata. Autoestinguenta Classe 1. Oltre ai formati standard, su richiesta si possono ottenere altre misure fino alla dimensione massima di cm. 203x305.

*Vinyl plates with cellular homogeneous structure, compact surface, satin finishing. Self-extinguishing class 1. In addition to the standard formats, on request you can get other measures to maximum size of cm. 203x305.*



### PVC ESPANSO BIANCO SPESSORE 3 MM

Codice art.	Dim. pannello		Pezzi per confezione	L.P.
	H.cm	L.cm.		
EUPVE0357	50	70	48	208
EUPVE03710	70	100	24	208
EUPVE031014	100	140	12	208
EUPVE031015	100	150	12	208
EUPVE031010	100	100	18	208
EUPVE035020	50	200	18	208
EUPVE037520	75	200	12	208
EUPVE031020	100	200	9	208
EUPVE031520	150	200	6	208

### PVC ESPANSO BIANCO SPESSORE 5 MM

Codice art.	Dim. pannello		Pezzi per confezione	L.P.
	H.cm	L.cm.		
EUPVE0557	50	70	32	224
EUPVE05710	70	100	16	224
EUPVE051014	100	140	8	224
EUPVE051015	100	150	8	224
EUPVE051010	100	100	12	224
EUPVE055020	50	200	12	224
EUPVE057520	75	200	8	224
EUPVE051020	100	200	6	224
EUPVE051520	150	200	4	224

### PVC ESPANSO BIANCO SPESSORE 8 MM

Codice art.	Dim. pannello		Pezzi per confezione	L.P.
	H.cm	L.cm.		
EUPVE0857	50	70	16	193
EUPVE08710	70	100	8	193
EUPVE081014	100	140	4	193
EUPVE081015	100	150	4	193
EUPVE081010	100	100	6	193
EUPVE085020	50	200	6	193
EUPVE087520	75	200	4	193
EUPVE081020	100	200	3	193
EUPVE081520	150	200	2	193

### PVC ESPANSO BIANCO SPESSORE 10 MM

Codice art.	Dim. pannello		Pezzi per confezione	L.P.
	H.cm	L.cm.		
EUPVE1057	50	70	16	214
EUPVE10710	70	100	8	214
EUPVE101014	100	140	4	214
EUPVE101015	100	150	4	214
EUPVE101010	100	100	6	214
EUPVE105020	50	200	6	214
EUPVE107520	75	200	4	214
EUPVE101020	100	200	3	214
EUPVE101520	150	200	2	214

### PVC ESPANSO NERO SPESSORE 3 MM

Codice art.	Dim. pannello		Pezzi per confezione	L.P.
	H.cm	L.cm.		
EUPVE0357N	50	70	48	316
EUPVE03710N	70	100	24	316
EUPVE031014N	100	140	12	316
EUPVE031015N	100	150	12	316
EUPVE031010N	100	100	18	316
EUPVE035020N	50	200	18	316
EUPVE037520N	75	200	12	316
EUPVE031020N	100	200	9	316
EUPVE031520N	150	200	6	316

### PVC ESPANSO NERO SPESSORE 5 MM

Codice art.	Dim. pannello		Pezzi per confezione	L.P.
	H.cm	L.cm.		
EUPVE0557N	50	70	32	372
EUPVE05710N	70	100	16	372
EUPVE051014N	100	140	8	372
EUPVE051015N	100	150	8	372
EUPVE051010N	100	100	12	372
EUPVE055020N	50	200	12	372
EUPVE057520N	75	200	8	372
EUPVE051020N	100	200	6	372
EUPVE051520N	150	200	4	372

### PVC ESPANSO NERO SPESSORE 10 MM

Codice art.	Dim. pannello		Pezzi per confezione	L.P.
	H.cm	L.cm.		
EUPVE1057N	50	70	16	372
EUPVE10710N	70	100	8	372
EUPVE101014N	100	140	4	372
EUPVE101015N	100	150	4	372
EUPVE101010N	100	100	6	372
EUPVE105020N	50	200	6	372
EUPVE107520N	75	200	4	372
EUPVE101020N	100	200	3	372
EUPVE101520N	150	200	2	372

# LASTRE POLIONDA

Lastra in polipropilene alveolare, leggero e facile da tagliare, risulta molto resistente agli sbalzi termici ed è quindi adatto anche ad usi esterni. Su richiesta, oltre ai formati standard, si possono ottenere altre misure fino alla dimensione massima di cm. 203x305.

*Sheet of honeycomb polypropylene, lightweight and easy to cut, it is very resistant to thermal shock and is therefore also suitable for outdoor use. On request, in addition to the standard sizes, you can get other measures up to the maximum size of cm. 203x305.*



## POLIONDA BIANCO SPESSORE 3 MM

Code art.	Dim. pannello		Pezzi per confezione	L.P.
	H.cm	L.cm.		
EUP00357	50	70	160	248
EUP003710	70	100	80	248
EUP0031014	100	140	40	248
EUP0031015	100	150	40	248
EUP0031010	100	100	60	248
EUP0035020	50	200	60	248
EUP0037520	75	200	40	248
EUP0031020	100	200	30	248
EUP0031520	150	200	20	248

## POLIONDA BIANCO SPESSORE 5 MM

Code art.	Dim. pannello		Pezzi per confezione	L.P.
	H.cm	L.cm.		
EUP00557	50	70	80	236
EUP005710	70	100	40	236
EUP0051014	100	140	20	236
EUP0051015	100	150	20	236
EUP0051010	100	100	30	236
EUP0055020	50	200	30	236
EUP0057520	75	200	20	236
EUP0051020	100	200	15	236
EUP0051520	150	200	10	236

## POLIONDA BIANCO SPESSORE 8 MM

Code art.	Dim. pannello		Pezzi per confezione	L.P.
	H.cm	L.cm.		
EUP00857	50	70	48	205
EUP008710	70	100	24	205
EUP0081014	100	140	12	205
EUP0081015	100	150	12	205
EUP0081010	100	100	18	205
EUP0085020	50	200	18	205
EUP0087520	75	200	12	205
EUP0081020	100	200	9	205
EUP0081520	150	200	6	205

## POLIONDA BIANCO SPESSORE 10 MM

Code art.	Dim. pannello		Pezzi per confezione	L.P.
	H.cm	L.cm.		
EUP01057	50	70	48	233
EUP010710	70	100	24	233
EUP0101014	100	140	12	233
EUP0101015	100	150	12	233
EUP0101010	100	100	18	233
EUP0105020	50	200	18	233
EUP0107520	75	200	12	233
EUP0101020	100	200	9	233
EUP0101520	150	200	6	233

## POLIONDA NERO SPESSORE 3 MM

Code art.	Dim. pannello		Pezzi per confezione	L.P.
	H.cm	L.cm.		
EUP00357N	50	70	160	310
EUP003710N	70	100	80	310
EUP0031014N	100	140	40	310
EUP0031015N	100	150	40	310
EUP0031010N	100	100	60	310
EUP0035020N	50	200	60	310
EUP0037520N	75	200	40	310
EUP0031020N	100	200	30	310
EUP0031520N	150	200	20	310

## POLIONDA NERO SPESSORE 5 MM

Code art.	Dim. pannello		Pezzi per confezione	L.P.
	H.cm	L.cm.		
EUP00557N	50	70	80	279
EUP005710N	70	100	40	279
EUP0051014N	100	140	20	279
EUP0051015N	100	150	20	279
EUP0051010N	100	100	30	279
EUP0055020N	50	200	30	279
EUP0057520N	75	200	20	279
EUP0051020N	100	200	15	279
EUP0051520N	150	200	10	279

## POLIONDA NERO SPESSORE 8 MM

Code art.	Dim. pannello		Pezzi per confezione	L.P.
	H.cm	L.cm.		
EUP00857N	50	70	48	260
EUP008710N	70	100	24	260
EUP0081014N	100	140	12	260
EUP0081015N	100	150	12	260
EUP0081010N	100	100	18	260
EUP0085020N	50	200	18	260
EUP0087520N	75	200	12	260
EUP0081020N	100	200	9	260
EUP0081520N	150	200	6	260

# LASTRE METACRILATO

## PERSPEX



Lastre in PMMA colato, trasparenti e leggere, con buona resistenza meccanica; eccezionale stabilità alla luce ed agli agenti atmosferici. Oltre ai formati standard, su richiesta si possono ottenere altre misure fino alla dimensione massima di cm. 203x305.

*PMMA sheets, transparent and light, with good mechanical strength; exceptional stability to light and atmospheric agents. In addition to standard formats, on request you can get other measures to maximum size of cm. 203x305.*

### PERSPEX TRASPARENTE SPESSORE 3 MM

Codice art.	Dim. pannello		Pezzi per confezione	L.P.
	H.cm	L.cm.		
EUPX0357	50	70	16	248
EUPX03710	70	100	8	248
EUPX031014	100	140	4	248
EUPX031015	100	150	4	248
EUPX031010	100	100	6	248
EUPX035020	50	200	6	248
EUPX037520	75	200	4	248
EUPX031020	100	200	3	248
EUPX031520	150	200	2	248

### PERSPEX TRASPARENTE SPESSORE 5 MM

Codice art.	Dim. pannello		Pezzi per confezione	L.P.
	H.cm	L.cm.		
EUPX0557	50	70	16	403
EUPX05710	70	100	8	403
EUPX051014	100	140	4	403
EUPX051015	100	150	4	403
EUPX051010	100	100	6	403
EUPX055020	50	200	6	403
EUPX057520	75	200	4	403
EUPX051020	100	200	3	403
EUPX051520	150	200	2	403

### PERSPEX TRASPARENTE SPESSORE 8 MM

Codice art.	Dim. pannello		Pezzi per confezione	L.P.
	H.cm	L.cm.		
EUPX0857	50	70	16	651
EUPX08710	70	100	8	651
EUPX081014	100	140	4	651
EUPX081015	100	150	4	651
EUPX081010	100	100	6	651
EUPX085020	50	200	6	651
EUPX087520	75	200	4	651
EUPX081020	100	200	3	651
EUPX081520	150	200	2	651

### PERSPEX TRASP. SPESSORE 10 MM

Codice art.	Dim. pannello		Pezzi per confezione	L.P.
	H.cm	L.cm.		
EUPX1057	50	70	16	812
EUPX10710	70	100	8	812
EUPX101014	100	140	4	812
EUPX101015	100	150	4	812
EUPX101010	100	100	6	812
EUPX105020	50	200	6	812
EUPX107520	75	200	4	812
EUPX101020	100	200	3	812
EUPX101520	150	200	2	812

### PERSPEX NERO SPESSORE 3 MM

Codice art.	Dim. pannello		Pezzi per confezione	L.P.
	H.cm	L.cm.		
EUPX0357N	50	70	16	285
EUPX03710N	70	100	8	285
EUPX031014N	100	140	4	285
EUPX031015N	100	150	4	285
EUPX031010N	100	100	6	285
EUPX035020N	50	200	6	285
EUPX037520N	75	200	4	285
EUPX031020N	100	200	3	285
EUPX031520N	150	200	2	285

### PERSPEX NERO SPESSORE 5 MM

Codice art.	Dim. pannello		Pezzi per confezione	L.P.
	H.cm	L.cm.		
EUPX0557N	50	70	16	465
EUPX05710N	70	100	8	465
EUPX051014N	100	140	4	465
EUPX051015N	100	150	4	465
EUPX051010N	100	100	6	465
EUPX055020N	50	200	6	465
EUPX057520N	75	200	4	465
EUPX051020N	100	200	3	465
EUPX051520N	150	200	2	465

### PERSPEX NERO SPESSORE 10 MM

Codice art.	Dim. pannello		Pezzi per confezione	L.P.
	H.cm	L.cm.		
EUPX1057N	50	70	16	930
EUPX10710N	70	100	8	930
EUPX101014N	100	140	4	930
EUPX101015N	100	150	4	930
EUPX101010N	100	100	6	930
EUPX105020N	50	200	6	930
EUPX107520N	75	200	4	930
EUPX101020N	100	200	3	930
EUPX101520N	150	200	2	930

### PERSPEX OPAL BIANCO SPESSORE 3 MM

Codice art.	Dim. pannello		Pezzi per confezione	L.P.
	H.cm	L.cm.		
EUPX03570P	50	70	16	248
EUPX037100P	70	100	8	248
EUPX0310140P	100	140	4	248
EUPX0310150P	100	150	4	248
EUPX0310100P	100	100	6	248
EUPX0350200P	50	200	6	248
EUPX0375200P	75	200	4	248
EUPX0310200P	100	200	3	248
EUPX0315200P	150	200	2	248

### PERSPEX OPAL BIANCO SPESSORE 5 MM

Codice art.	Dim. pannello		Pezzi per confezione	L.P.
	H.cm	L.cm.		
EUPX05570P	50	70	16	403
EUPX057100P	70	100	8	403
EUPX0510140P	100	140	4	403
EUPX0510150P	100	150	4	403
EUPX0510100P	100	100	6	403
EUPX0550200P	50	200	6	403
EUPX0575200P	75	200	4	403
EUPX0510200P	100	200	3	403
EUPX0515200P	150	200	2	403

### PERSPEX OPAL BIANCO SPESSORE 10 MM

Codice art.	Dim. pannello		Pezzi per confezione	L.P.
	H.cm	L.cm.		
EUPX10570P	50	70	16	812
EUPX107100P	70	100	8	812
EUPX1010140P	100	140	4	812
EUPX1010150P	100	150	4	812
EUPX1010100P	100	100	6	812
EUPX1050200P	50	200	6	812
EUPX1075200P	75	200	4	812
EUPX1010200P	100	200	3	812
EUPX1015200P	150	200	2	812

# LASTRE KARTOON

Lastre sandwich con nucleo in cartone alveolare ed esterno in carta, rigide e leggere; riciclabili, è possibile tagliarle e bordarle. Oltre ai formati standard, su richiesta si possono ottenere altre misure fino alla dimensione massima di cm. 203x305.

*Sandwich plates with honeycomb cardboard core and outer paper, light and stiff; recyclable, you can cut and edged them. In addition to standard formats, on request you can get other measures to a maximum size of cm. 203x305.*



## LASTRA KARTOON SPESSORE 10 MM

Codice art.	Dim. pannello		Pezzi per confezione	L.P.
	H.cm	L.cm.		
EUKAT1057	50	70	16	143
EUKAT10710	70	100	8	143
EUKAT101014	100	140	4	143
EUKAT101015	100	150	4	143
EUKAT101010	100	100	6	143
EUKAT105020	50	200	6	143
EUKAT107520	75	200	4	143
EUKAT101020	100	200	3	143
EUKAT101520	150	200	2	143

## LASTRA KARTOON SPESSORE 15 MM

Codice art.	Dim. pannello		Pezzi per confezione	L.P.
	H.cm	L.cm.		
EUKAT1557	50	70	16	152
EUKAT15710	70	100	8	152
EUKAT151014	100	140	4	152
EUKAT151015	100	150	4	152
EUKAT151010	100	100	6	152
EUKAT155020	50	200	6	152
EUKAT157520	75	200	4	152
EUKAT151020	100	200	3	152
EUKAT151520	150	200	2	152

## LASTRA KARTOON SPESSORE 20 MM

Codice art.	Dim. pannello		Pezzi per confezione	L.P.
	H.cm	L.cm.		
EUKAT2057	50	70	16	162
EUKAT20710	70	100	8	162
EUKAT201014	100	140	4	162
EUKAT201015	100	150	4	162
EUKAT201010	100	100	6	162
EUKAT205020	50	200	6	162
EUKAT207520	75	200	4	162
EUKAT201020	100	200	3	162
EUKAT201520	150	200	2	162



Prodotto composto ottenuto dall'accoppiamento di due superfici di alluminio con interposto un nucleo di polietilene nero. Le superfici esterne sono verniciate con lacche in poliestere, disponibili nelle tipologie:

## STANDARD

bianco/bianco, silver/silver, nero/nero, rosso/rosso, arancio/arancio, blu/blu un lato lucido e l'altro opaco.

## SPECIALI

Spazzolato silver e nero, su entrambi i lati, specchio argento solo su un lato.

*Product made by double aluminum composed with polyethylene nucleus between them. Painted polyester surfaces, available in three different choice:*

## STANDARD

*white/white, silver/silver, black/black, orange/orange, bleu/bleu one side glossy one side matt.*

## SPECIAL

*Brushed silver and black both side, silver mirror only one side.*

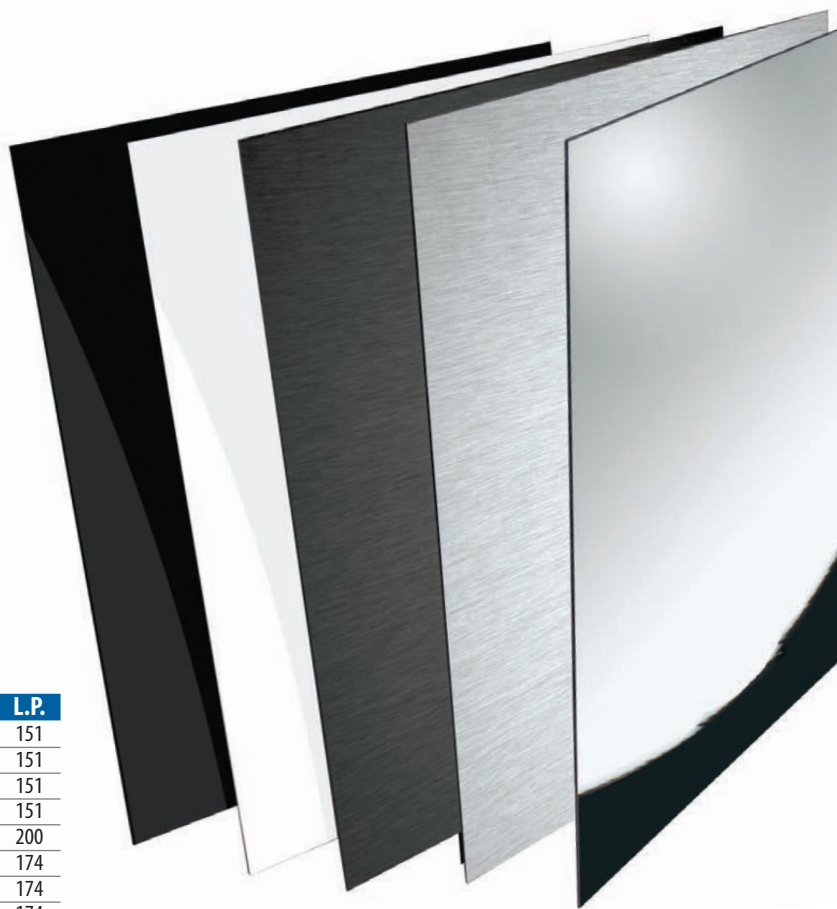

## EUROBOND BIANCO/BIANCO

Codice art.	Colore	Spess mm.	Dim. cm.	Pezzi conf.	L.P.
EUBD0257B	bianco	2	50x70	12	151
EUBD02710B	bianco	2	70x100	6	151
EUBD021014B	bianco	2	100x140	3	151
EUBD021015B	bianco	2	100x150	3	151
EUBD021520B	bianco	2	150x200	2	200
EUBD0357B	bianco	3	50x70	12	174
EUBD03710B	bianco	3	70x100	6	174
EUBD031014B	bianco	3	100x140	3	174
EUBD031015B	bianco	3	100x150	3	174
EUBD031520B	bianco	3	150x200	2	231

## EUROBOND SILVER/SILVER

Codice art.	Colore	Spess mm.	Dim. cm.	Pezzi conf.	L.P.
EUBD0257S	silver	2	50x70	12	151
EUBD02710S	silver	2	70x100	6	151
EUBD021014S	silver	2	100x140	3	151
EUBD021015S	silver	2	100x150	3	151
EUBD021520S	silver	2	150x200	2	200
EUBD0357S	silver	3	50x70	12	174
EUBD03710S	silver	3	70x100	6	174
EUBD031014S	silver	3	100x140	3	174
EUBD031015S	silver	3	100x150	3	174
EUBD031520S	silver	3	150x200	2	231

## EUROBOND SPAZZOLATO SILVER

Codice art.	Colore	Spess mm.	Dim. cm.	Pezzi conf.	L.P.
EUBD0357BS	brushed silver	3	50x70	12	215
EUBD03710BS	brushed silver	3	70x100	6	215
EUBD031014BS	brushed silver	3	100x140	3	215
EUBD031015BS	brushed silver	3	100x150	3	215

## EUROBOND SPAZZOLATO NERO

Codice art.	Colore	Spess mm.	Dim. cm.	Pezzi conf.	L.P.
EUBD0357BN	brushed nero	3	50x70	12	267
EUBD03710BN	brushed nero	3	70x100	6	267
EUBD031014BN	brushed nero	3	100x140	3	267
EUBD031015BN	brushed nero	3	100x150	3	267

## EUROBOND SPECCHIO

Codice art.	Colore	Spess mm.	Dim. cm.	Pezzi conf.	L.P.
EUBD03712SS	specchio	3	75x120	4	260
EUBD031512SS	specchio	3	150x120	2	260
EUBD0356SS	specchio	3	50x60	12	260
EUBD031012SS	specchio	3	100x120	3	260
EUBD032012SS	specchio	3	200x120	2	344

## EUROBOND NERO/NERO

Codice art.	Colore	Spess mm.	Dim. cm.	Pezzi conf.	L.P.
EUBD0357N	nero	3	50x70	12	174
EUBD03710N	nero	3	70x100	6	174
EUBD031014N	nero	3	100x140	3	174
EUBD031015N	nero	3	100x150	3	174
EUBD031520N	nero	3	150x200	2	231

## EUROBOND ROSSO/ROSSO

Codice art.	Colore	Spess mm.	Dim. cm.	Pezzi conf.	L.P.
EUBD0357R	rosso	3	50x70	12	174
EUBD03710R	rosso	3	70x100	6	174
EUBD031014R	rosso	3	100x140	3	174
EUBD031015R	rosso	3	100x150	3	174

## EUROBOND BLU/BLU

Codice art.	Colore	Spess mm.	Dim. cm.	Pezzi conf.	L.P.
EUBD0357BL	blu	3	50x70	12	174
EUBD03710BL	blu	3	70x100	6	174
EUBD031014BL	blu	3	100x140	3	174
EUBD031015BL	blu	3	100x150	3	174

## EUROBOND ARANCIO/ARANCIO

Codice art.	Colore	Spess mm.	Dim. cm.	Pezzi conf.	L.P.
EUBD0357A	arancio	3	50x70	12	174
EUBD03710A	arancio	3	70x100	6	174
EUBD031014A	arancio	3	100x140	3	174
EUBD031015A	arancio	3	100x150	3	174



## DA UTILIZZARE CON COLLA METYLAN INSTANT



**COLLA PER PARATI CON SUPPORTO IN TNT**, pronta in 3 minuti, applicazione senza schizzi; confezione 200 gr.

**WALLPAPER GLUE WITH TNT support, ready in 3 minutes, no splash application; package 200 gr.**

### Perfetto per creare ambienti personalizzati ovunque:

- Hotel e centri conferenze
- Centri commerciali, punti vendita
- Uffici e sale riunioni
- Scuole e università
- Ospedali e cliniche
- Aeroporti e stazioni ferroviarie

### Adatto a molteplici applicazioni:

- Progettato per ambienti difficili
- Facile applicazione
- Resistente all'acqua e lavabile
- Removibile non lascia residui
- Stampabile con inchiostri Eco/UV/Latex
- BioPruf® (antibatterica) ed a prova di fuoco

### SPECIFICHE TECNICHE ED INFORMAZIONI

#### Composizione

Substrato in TNT con rivestimento superficiale in vinile

#### Proprietà

Rivestimento speciale studiato per un'ottima stampa con tutte le stampanti inkjet eco-solvent, UV e Latex. Applicazione facile e veloce, la colla si applica sulla parete (non sulla carta da parati stampata). Removibile senza lasciare residui.

#### Bio-Pruf®

Trattamento speciale che inibisce la crescita di microorganismi (batteri e muffa)

#### Lavabile

Dopo la stampa può essere lavato con un detergente neutro ed un panno umido.

#### Adesivi

Si utilizza con i normali adesivi standard per carte da parati-PVA, consigliato Henkel Metylan Instant

#### Conformità

Conforme alla norma EN 259-2

#### Sicurezza/Ecologia

Materiale classificato come non pericoloso DIN 52900 or 91/155/EEG,2001/58/EC

#### Resistenza al fuoco

*Kernow Jet INTERIORS 500*: Euro class B s 1d0 • Class 0 / 1 BS 476 part 6/7 • M1NF P 92501/ 92507

B1 DIN 4102 - 01 ABP Numero P-MPA-E04-507

*Kernow Jet INTERIORS 620*: ASTM Test-Method E84 - 15a

#### Resistenza alla luce

≥ 7 International Wooscale BS EN 20105 / ISO 105-B02

### SCHEDA TECNICA

Codice art.	Descrizione	Altezza cm	Lungh. mt	L.P. mtl
KCWALLBAM5001350	Wallcovering Bamboo 500	130	50	13,15
KCWALLBRU5001350	Wallcovering Brush 500	130	50	13,15
KCWALLCNV6201330	Wallcovering Canvas 620	130	30,5	18,75
KCWALLLIG6201330	Wallcovering Light Touch 620	130	30,5	18,75
KCWALLDUS5001350	Wallcovering Dust 500	130	50	13,15
KCWALLFAC5001350	Wallcovering Facade 500	130	50	13,15
KCWALLCNV5001330	Wallcovering Light Canvas 500	130	30,5	13,15
KCWALLLIN5001330	Wallcovering Linnen 500	130	30,5	13,15
KCWALLPAR5001350	Wallcovering Parchment 500	130	50	13,15
KCWALLPOR5001350	Wallcovering Porcelain 500	130	50	13,15
KCWALLRUS5001350	Wallcovering Rustique 500	130	50	13,15
KCWALLSAN5001350	Wallcovering Sand 500	130	50	13,15
KCWALLSMO5001330	Wallcovering Smooth Touch 500	130	30,5	13,15
HKMYINSANT	Colla gr. 200 Henkel Metylan Istant (resa 22 mq)			24 cad.



# Supporti da parati digitali (PVC+TNT) struttura bianca per Eco-solvent, UV, Latex



SMOOTH TOUCH 500

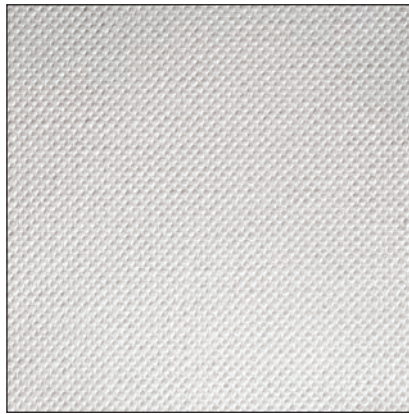

LIGHT CANVAS 500

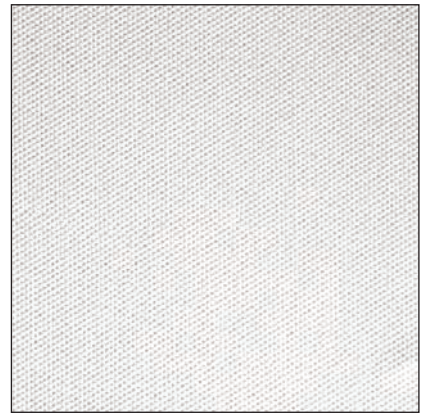

LINNEN 500



DUST

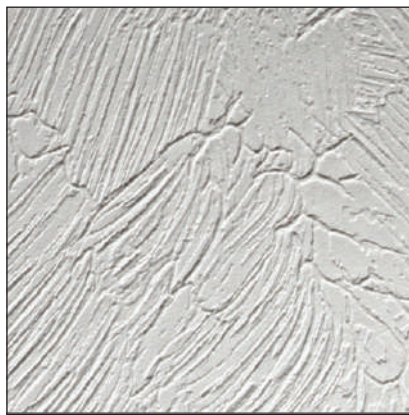

BRUSH



PORCELAIN



RUSTIQUE



PARCHMENT



BAMBOO



SAND



FACADE



CANVAS 620

# CARTA TRANSFER PER STAMPANTI LASER



## FREE STYLE DARK

per tessuti scuri autoscontornante

### ISTRUZIONI PER LA STAMPA

Materiale adatto per trasferire immagini colorate su tessuti scuri con stampanti OKI toner bianco (opacità -3)

**Impostazione carta:** trasparente

**Qualità di stampa:** 1200x600 dpi, Stampa speculare, lato opaco, Pressione media. Se presente rimuovere il teflon dalla lastra inferiore

### ISTRUZIONI PER IL LAVAGGIO

1. Massimo a 40°C
2. Non usare candeggina, non mettere in asciugatrice
3. Non stirare sulla zona trasferita, coprire con carta da forno

### ISTRUZIONI APPLICAZIONE

#### Free Style Dark Standard:

1. Tempo di trasferimento: 60 secondi
2. Rimuovere il liner dopo 3/10 secondi
3. Tempo di trasferimento: 30/60 secondi
4. Rimuovere il Tessuto e farlo raffreddare; spellicolare a freddo

#### Free Style Dark a lunga durata:

1. Coprire l'immagine trasferita con carta siliconata e pressare per altri 15 secondi

Codice art.	Fogli a conf.	Formato	L.P.
TCFREESDA3AB	100	A3	720



## COPYFUN BLACK

per tessuti scuri

### ISTRUZIONI PER LA STAMPA

Materiale adatto per stampanti laser olio e non olio

**Impostazione carta:** labels

**Qualità di stampa:** 1200x600 dpi, Stampa frontale, Rimuovere il liner prima del trasferimento. Coprire l'immagine con la carta siliconata

### ISTRUZIONI PER IL PLOTTER

**Pressione:** 90gr Penna: 60gr  
**Punta della lama per offset:** +/- 0,25 mm  
**Sovrataglio:** 1mm Velocità: 10 cm/sec.

1. Tempo di trasferimento: 20 secondi
2. Temperatura: 150°C/304°F
3. Pressione: media/alta
4. Rimuovere il liner a freddo

### ISTRUZIONI PER IL LAVAGGIO

1. Prima di lavare mettere la maglietta al contrario
2. Lavaggio per i capi delicati a massimo 30°C con sapone neutro
3. Stendere per l'asciugatura
4. Stirare al contrario

Codice art.	Fogli a conf.	Formato	L.P.
BTCF401A3	100	A3	560



## COPYFUN BLU

per tessuti chiari per olio e non

### ISTRUZIONI PER LA STAMPA

materiale adatto per stampanti laser olio e non olio

**Impostazione carta:** heavy

**Qualità di stampa:** 1200x600 dpi

**Impostazione della stampa:** speculare

1. Tempo di trasferimento: 15 secondi
2. Temperatura: 190°C/375°F
3. Pressione: medio/alta
4. Rimuovere il liner dopo 2 secondi

### ISTRUZIONI PER IL LAVAGGIO

1. Prima di lavare mettere la maglietta al contrario
2. Lavaggio per i capi delicati a massimo 30°C con sapone neutro
3. Stendere per l'asciugatura
4. Stirare al contrario

Codice art.	Fogli a conf.	Formato	L.P.
BTCF117A3	100	A3	126



## COPYFUN PINK

per tessuti chiari autoscontornante

### ISTRUZIONI PER LA STAMPA

materiale adatto per stampanti laser non ad olio

**Impostazione carta:** extra heavy

**Qualità di stampa:** 1200x600 dpi

1. Tempo di trasferimento: 20/25 secondi
2. Temperatura: 175°C
3. Pressione: medio alta
4. Rimozione del liner: dopo 5 secondi
5. Seconda pressata: 30 secondi con carta siliconata, pressione media

### ISTRUZIONI PER IL LAVAGGIO

1. Prima di lavare mettere la maglietta al contrario
2. Lavaggio per i capi delicati a massimo 30°C con sapone neutro
3. Stendere per l'asciugatura
4. Stirare al contrario

Codice art.	Fogli a conf.	Formato	L.P.
BTCF107A3	100	A3	240



## COPYFUN GREY

per tazze e metalli

### ISTRUZIONI PER IL TRASFERIMENTO CON PRESSA PIANA COMMERCIALE

1. Stampa speculare
2. Tagliare la parte in eccesso ma lasciare 3mm di bordo
3. Posizionare la carta trasfer sul materiale scelto con un application tape in poliestere adatto ad alte temperature
4. Metallo e alluminio: 120 secondi con una base in silicone
5. Legno e cartone: 5 secondi senza base in silicone
6. Rimuovere la carta transfer dopo 5 minuti

### ISTRUZIONI PER IL TRASFERIMENTO CON LA STAMPANTE TONDA PER TAZZE

1. Stampa speculare
2. Tagliare la parte in eccesso ma lasciare 3mm di bordo
3. Trasferimento: 175° per 3 minuti
4. Rimuovere la carta transfer dopo 5 minuti
5. Cuocere in forno per 5 minuti a 200°

Codice art.	Fogli a conf.	Formato	L.P.
BTCF109A3	100	A3	100

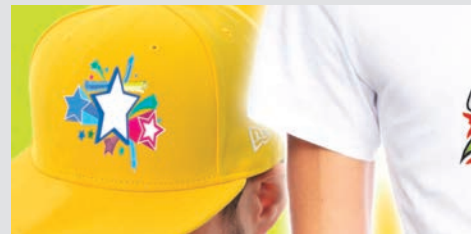

## COPYFUN ORANGE

per tessuti chiari per olio e non

### ISTRUZIONI PER LA STAMPA

materiale adatto per stampanti laser non olio

**Impostazione carta:** labels

**Qualità di stampa:** 1200x600 dpi

**Impostazione della stampa:** speculare

1. Tempo di trasferimento: 15 secondi
2. Temperatura: 190°C/375°F
3. Pressione: medio/alta
4. Rimuovere il liner dopo 2 secondi

### ISTRUZIONI PER IL LAVAGGIO

1. Prima di lavare mettere la maglietta al contrario
2. Lavaggio per i capi delicati a massimo 30°C con sapone neutro
3. Stendere per l'asciugatura
4. Stirare al contrario

Codice art.	Fogli a conf.	Formato	L.P.
BTCF117A3	100	A3	126

# SUPPORTI LASER PREFUSTELLATI

## BADGE BAGAGLIO

- Film pre-fustellato pronto per la stampa
- Bianco opaco stampabile su entrambi i lati
- Waterproof, non necessita di laminazione
- Peso 260 g/mq
- Spessore 195 my

Codice art.	Formato	Fogli conf.	L.P.
KC195HWTLTA4	A4	100	130

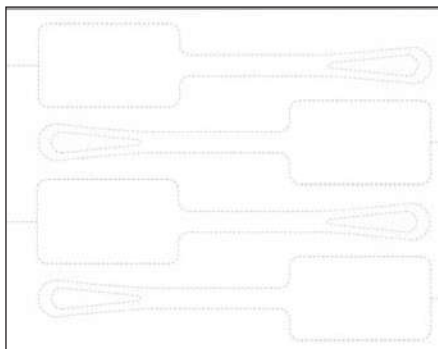

## FUORIPORTA

- Film pre-fustellato pronto per la stampa
- Bianco opaco stampabile su entrambi i lati
- Waterproof, non necessita di laminazione
- Peso 260 g/mq
- Spessore 195 my

Codice art.	Formato	Fogli conf.	L.P.
KC195HWT6UPDHA4	A4	100	130

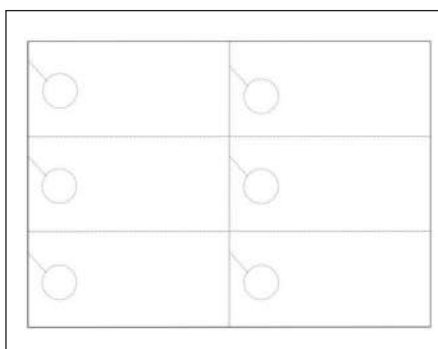

## MENU 2 LATI

- Film pre-fustellato pronto per la stampa per menu' o brochure
- Bianco opaco stampabile su entrambi i lati
- Waterproof, non necessita di laminazione
- Peso 260 g/mq
- Spessore 195 my

Codice art.	Formato	Fogli conf.	L.P.
KC195HWTVPFA4	A4	50	69



## MENU 3 LATI

- Film pre-fustellato pronto per la stampa per menu' o brochure
- Bianco opaco stampabile su entrambi i lati
- Waterproof, non necessita di laminazione
- Peso 260 g/mq
- Spessore 195 my

Codice art.	Formato	Fogli conf.	L.P.
KC195HWTTRIA4	A4	50	69

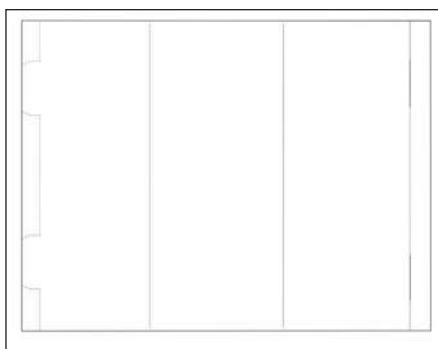

## BRACCIALE

- Film pre-fustellato pronto per la stampa
- Bianco e colorati opachi stampabili su entrambi i lati
- Ideale per eventi sportivi, musicali, ospedali
- Misura mm. 18x265
- Waterproof, non necessita di laminazione
- Peso 160 g/mq
- Spessore 120 my

Codice art.	Formato	Fogli conf.	L.P.
KC120HWN58WB	A4	100	241

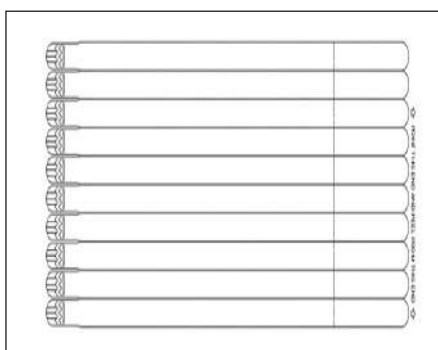



#### SCHEDA TECNICA ORABOND 1395 TM

Codice art.	Descrizione	Spess. My	Alt. mm.	Lungh. mt.	L.P.
OF1395TM12	Biadesivo tenace trasparente	130	12	50	8,60
OF1395TM19	Biadesivo tenace trasparente	130	19	50	13,50
OF1395TM25	Biadesivo tenace trasparente	130	25	50	17,80
OF1395TM50	Biadesivo tenace trasparente	130	50	50	35,60

#### SCHEDA TECNICA ORABOND 1392 TM

Codice art.	Descrizione	Spess. mm.	Alt. mm.	Lungh. mt.	L.P.
1392TM12	Biadesivo tenace bianco	2,6	12	50	12,70
1392TM19	Biadesivo tenace bianco	2,6	19	50	20,10
1392TM25	Biadesivo tenace bianco	2,6	25	50	26,40
1392TM50	Biadesivo tenace bianco	2,6	50	50	52,80

#### SCHEDA TECNICA ORAMOUNT 1819 TM

Codice art.	Descrizione	Spess. mm.	Alt. mm.	Lungh. mt.	L.P.
OF1819TM12	Biadesivo schiuma bianco	2,1	12	25	8,70
OF1819TM19	Biadesivo schiuma bianco	2,1	19	25	13,60
OF1819TM25	Biadesivo schiuma bianco	2,1	25	25	17,90
OF1819TM50	Biadesivo schiuma bianco	2,1	50	25	35,80

#### SCHEDA TECNICA ORABOND 1397 PP

Codice art.	Descrizione	Spess. mm.	Alt. mm.	Lungh. mt.	L.P.
OF1397PP12	Biadesivo tenace prot. rossa	2,1	12	50	14,20
OF1397PP19	Biadesivo tenace prot. rossa	2,1	19	50	22,50
OF1397PP25	Biadesivo tenace prot. rossa	2,1	25	50	29,60
OF1397PP50	Biadesivo tenace prot. rossa	2,1	50	50	59,20

#### SCHEDA TECNICA ORABOND 1459 TM

Codice art.	Descrizione	Spess. mm.	Alt. mm.	Lungh. mt.	L.P.
OF1459TM12	Biadesivo Ruber tenace prot. rossa	1,4	12	50	5,20
OF1459TM19	Biadesivo Ruber tenace prot. rossa	1,4	19	50	8,20
OF1459TM25	Biadesivo Ruber tenace prot. rossa	1,4	25	50	10,80
OF1459TM50	Biadesivo Ruber tenace prot. rossa	1,4	50	50	21,60

#### SCHEDA TECNICA ORABOND 1397 TM

Codice art.	Descrizione	Spess. My	Alt. mm.	Lungh. mt.	L.P.
OF1397TM12	Biadesivo tenace trasparente	210	12	50	12,40
OF1397TM19	Biadesivo tenace trasparente	210	19	50	19,60
OF1397TM25	Biadesivo tenace trasparente	210	25	50	25,70
OF1397TM50	Biadesivo tenace trasparente	210	50	50	51,40

#### SCHEDA TECNICA ORAMOUNT 1812 TM

Codice art.	Descrizione	Spess. mm.	Alt. mm.	Lungh. mt.	L.P.
OF1812TM12	Biadesivo schiuma bianco	1,1	12	25	4,80
OF1812TM19	Biadesivo schiuma bianco	1,1	19	25	7,60
OF1812TM25	Biadesivo schiuma bianco	1,1	25	25	10,00
OF1812TM50	Biadesivo schiuma bianco	1,1	50	25	20,00

#### SCHEDA TECNICA ORABOND 1810

Codice art.	Descrizione	Spess. mm.	Alt. mm.	Lungh. mt.	L.P.
OF181012	Biadesivo schiuma bianco	1,1	12	50	11,00
OF181019	Biadesivo schiuma bianco	1,1	19	50	17,50
OF181025	Biadesivo schiuma bianco	1,1	25	50	23,00
OF181050	Biadesivo schiuma bianco	1,1	50	50	46,00

#### SCHEDA TECNICA ORAFILM 1377

Codice art.	Descrizione	Spess. mm.	Alt. mm.	Lungh. mt.	L.P.
OF1377LAS30	Biadesivo solo colla per taglio laser	1,2	305	50	354
OF1377LAS60	Biadesivo solo colla per taglio laser	1,2	610	50	708

#### SCHEDA TECNICA ORABOND 1822

Codice art.	Descrizione	Spess. mm.	Alt. mm.	Lungh. mt.	L.P.
OF182212	Biadesivo schiuma nera	1,1	12	50	4,80
OF182219	Biadesivo schiuma nera	1,1	19	50	7,60
OF182225	Biadesivo schiuma nera	1,1	25	50	10,00
OF182250	Biadesivo schiuma nera	1,1	50	50	20,00

# APPENDINI



Serie di appendini per il fissaggio a parete di pannelli leggeri, disponibili in due varianti: in plastica con autoadesivo oppure in metallo a perforazione.

*Hangers for light panels wall mounting, available either in plastic with self-adhesive or metallic for perforation fixing.*



M5APPAD1



M5APPAD2



M5APPAD3

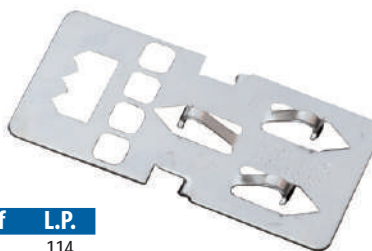

GRIP1



GRIP2

## SCHEDA TECNICA

Codice art.	Descrizione	Pz/conf	L.P.
M5APPAD1	Appendino autoad. dim. mm 41x70	100	52
M5APPAD2	Appendino autoad. dim. mm 38x22	1000	110
M5APPAD3	Appendino autoad. dim. mm 35x40	1000	220

## SCHEDA TECNICA

Codice art.	Descrizione	Pz/conf	L.P.
FRGRIP1	Appendino a perforazione per pannelli piuma, kapa	200	114
FRGRIP2	Appendino a perforazione per pannelli tipo forex	200	114

Appendini autoadesivi in plastica trasparente, dimensioni placca mm. 70x70 con gancio larghezza mm. 25 in cui è possibile inserire uno spessore massimo di mm. 4; si attaccano su vetro, specchio, ceramica, marmo, tessuto, acciaio ecc.

*Self-adhesive transparent hangers, plate size mm. 70x70 and hook size mm. 25 that fits mm. 4 maximum thickness; they stick on glass, mirror, ceramic, marble, tiles, steel, etc.*



spessore massimo di mm. 4

## SCHEDA TECNICA

Codice art.	Descrizione	Pz/conf	L.P.
LIAPPHOOK	Appendino autoadesivo dim. mm 70x70	4	20

Serie di appendini autoadesivi in acciaio per il fissaggio a parete di pannelli fino ad un massimo di 13 kg per la versione più grande; sono disponibili in 4 dimensioni diverse.

*Self-adhesive steel hangers for panels fixing until maximum 13 Kg weight for the biggest version; 4 different sizes available.*

## SCHEDA TECNICA

Codice art.	Descrizione	Pz/conf	L.P.
LIAPPACC4560	Appendino mm. 80x40 fino a 6 kg	10	16
LIAPPACC8040	Appendino mm. 60x45 fino a 10 kg	10	14
LIAPPACC8060	Appendino mm. 60x80 fino a 13 kg	10	18
LIAPPACC8080	Appendino mm. 80x80 fino a 13 kg	10	20



6045

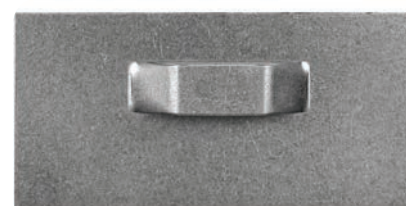

8040

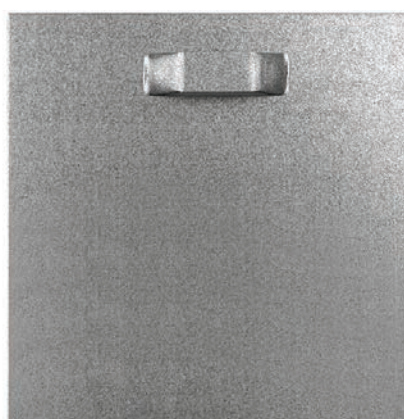
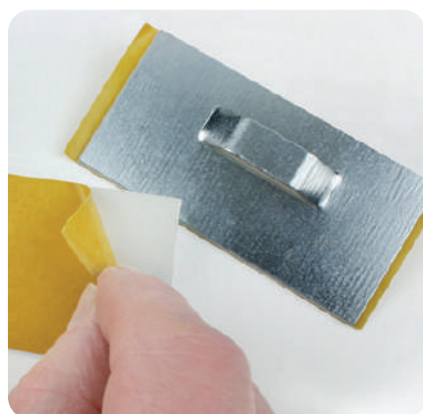

8080



6080

# GANCIO E UNCINO



Sistema di chiusura a gancio con tessuto, autoadesivo, per il fissaggio di tessuti, pannelli e banner. Lunghezza bobina mt. 25, disponibile in diversi spessori come indicato nella scheda tecnica.

Closing system with hook fabric, self-adhesive, for fixing fabrics, panels and banners. Roll length mt. 25, available in various thicknesses as shown in the data sheet.



## SCHEDA TECNICA

Codice art.	Descrizione	L.P.
ARGA20B	Fissaggio autoadesivo a gancio dim. mm. 20x25 mt.	32
ARUN20B	Fissaggio autoadesivo tessuto dim. mm. 20x25 mt.	32
ARGA38B	Fissaggio autoadesivo a gancio dim mm. 38x25 mt.	57
ARUN38B	Fissaggio autoadesivo tessuto dim. mm. 38x25 mt.	57
ARGA50B	Fissaggio autoadesivo a gancio dim mm. 50x25 mt.	74
ARUN50B	Fissaggio autoadesivo tessuto dim. mm. 50x25 mt.	
ARGA20N	Fissaggio autoadesivo gancio nero dim. mm. 20x25 mt.	32
ARUN20N	Fissaggio autoadesivo tessuto nero dim. mm. 20x25 mt.	32

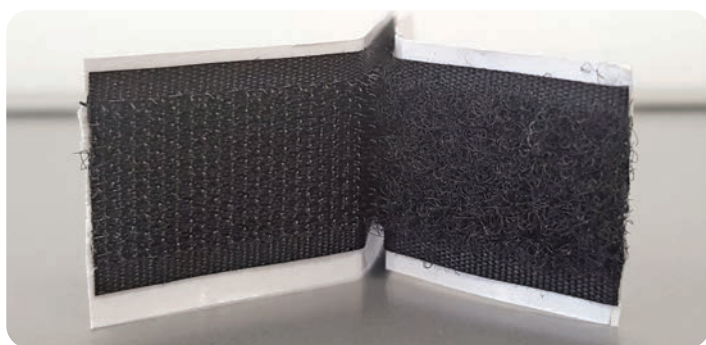

Gancio più Uncino Nero



Gancio più Uncino Bianco

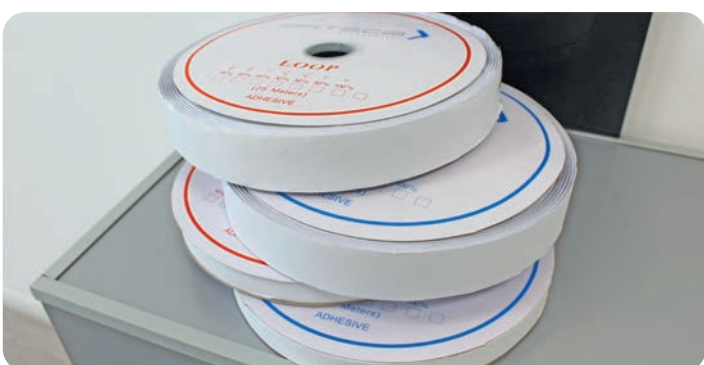

# PROFILI ALU E PLAST

Serie di profili particolarmente utili per la decorazione, il montaggio e la protezione di poster e pannelli rigidi come PVC, Piuma, ecc. Sono disponibili in PVC antiurto o in alluminio, facili da tagliare, il montaggio avviene mediante inserimento del pannello, a pressione.

*Series of profiles especially useful for the decoration, the mounting and protecting Poster and rigid panels such as PVC, Piuma (sandwich sheet), etc. They are available in shockproof PVC or aluminum, easy to cut, assembly is completed by insertion of the panel, to pressure.*

## SCHEDA TECNICA PROFILI IN PVC A "U" PER PANNELLI

Codice art.	Descrizione	Colore	Spess. int. mm.	Lunghezza cm.	L.P
SBEPU-B04	Profilo in pvc a "U"	bianco	3-4	312	7
SBEPU-B06	Profilo in pvc a "U"	bianco	5-6	312	8
SBEPU-B10	Profilo in pvc a "U"	bianco	8-10	312	9
SBEPU-N04	Profilo in pvc a "U"	nero	3-4	312	7
SBEPU-N06	Profilo in pvc a "U"	nero	5-6	312	8
SBEPU-N10	Profilo in pvc a "U"	nero	8-10	312	9

## SCHEDA TECNICA PROFILI IN PVC A "L" PER PANNELLI

Codice art.	Descrizione	Colore	Lati mm.	Lunghezza cm.	L.P
AGP-25N	Profilo in pvc a "L"	Nero	25x25	200	6
AGP-25B	Profilo in pvc a "L"	Bianco	25x25	200	6
AGP-2010N	Profilo in pvc a "L"	Nero	20x10	200	3
AGP-2520N	Profilo in pvc a "L"	Nero	25x20	200	4
AGP-3020N	Profilo in pvc a "L"	Nero	30x20	200	5
AGP-4010N	Profilo in pvc a "L"	Nero	40x10	200	6
AGP-2010B	Profilo in pvc a "L"	Bianco	20x10	200	3
AGP-2520B	Profilo in pvc a "L"	Bianco	25x20	200	4
AGP-3020B	Profilo in pvc a "L"	Bianco	30x20	200	5
AGP-4010B	Profilo in pvc a "L"	Bianco	40x10	200	6

## SCHEDA TECNICA PROFILI IN PVC A "W" PER PANNELLI

Codice art.	Descrizione	Colore	Spess. int. mm.	Lunghezza cm.	L.P
SBEPW-B05	Profilo in pvc a "W"	Bianco	5-6	312	25
SBEPW-B10	Profilo in pvc a "W"	Bianco	8-10	312	27
SBEPW-N05	Profilo in pvc a "W"	Nero	5-6	312	25
SBEPW-N10	Profilo in pvc a "W"	Nero	8-10	312	27

## SCHEDA TECNICA PROFILI IN PVC A "H" PER PANNELLI

Codice art.	Descrizione	Colore	Spess. int. mm.	Lunghezza cm.	L.P
SBEPH-B04	Profilo in pvc a "H"	Bianco	3-4	312	17
SBEPH-B06	Profilo in pvc a "H"	Bianco	5-6	312	18
SBEPH-B10	Profilo in pvc a "H"	Bianco	8-10	312	23

## SCHEDA TECNICA PROFILI IN ALLUMINIO A "L" PER PANNELLI

Codice art.	Descrizione	Colore	Lati mm.	Lunghezza cm.	L.P
AGP-20S	Profilo in alluminio a "L"	Silver	20x20	200	10
AGP-25S	Profilo in alluminio a "L"	Silver	25x25	200	12
AGP-30S	Profilo in alluminio a "L"	Silver	30x30	200	14
AGP-40S	Profilo in alluminio a "L"	Silver	40x40	200	22

## SCHEDA TECNICA PROFILI IN ALLUMINIO A "U" PER PANNELLI

Cod.art.	Descrizione	Colore	Lati mm.	Spess. int. mm	Lungh. cm.	L.P
CU1510	Profilo in alluminio a "U"	Silver	15x10	8	200	10
CU2010	Profilo in alluminio a "U"	Silver	20x10	8	200	14

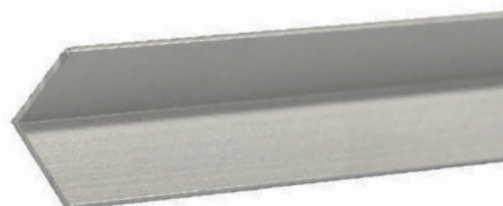
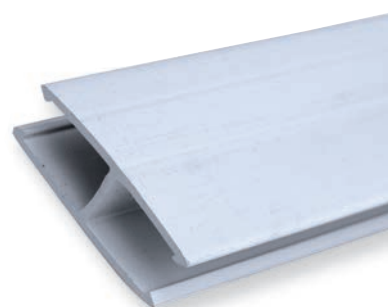
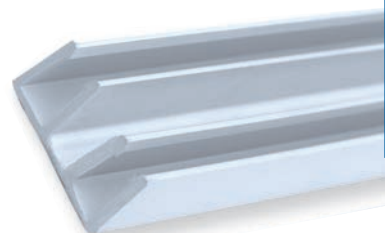
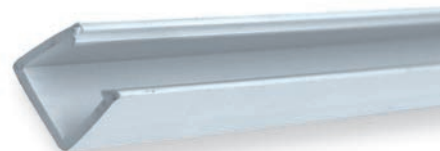

# PROFILI TECHNO

Profili tubolari a sezione quadra da mm. 25 in alluminio anodizzato argento, per la composizione di solide strutture tridimensionali; facili da assemblare e smontare grazie ai giunti che consentono il fissaggio tramite l'uso di un semplice martello. Disponibili in varie misure e tipologie.

*Tubular profiles with a square section, from mm. 25 silver anodized aluminum, for the composition of the solid three-dimensional structures; easy to assemble and disassemble thanks to the joints that allow the fixing by the use of a simple hammer. Available in different sizes and types.*

## SCHEDA TECNICA PROFILO QUADRO

Codice art.	Descrizione	L.P.
EU10A50	Tubo quadro dim. mm. 25x25 lungh. cm. 50	4,99
EU10A75	Tubo quadro dim. mm. 25x25 lungh. cm. 75	7,49
EU10A100	Tubo quadro dim. mm. 25x25 lungh. cm. 100	9,98
EU10A150	Tubo quadro dim. mm. 25x25 lungh. cm. 150	14,97
EU10A200	Tubo quadro dim. mm. 25x25 lungh. cm. 200	19,96
EU10A300	Tubo quadro dim. mm. 25x25 lungh. cm. 300	29,94

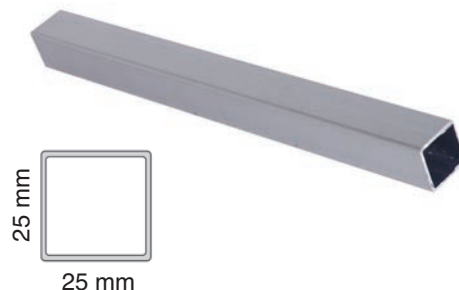

## SCHEDA TECNICA PROFILO QUADRO CON ALETTA 5 MM.

Codice art.	Descrizione	L.P.
EU60A550	Tubo quadro con 1 aletta da mm.5 dim. mm. 25x25 lungh. cm. 50	6,25
EU60A575	Tubo quadro con 1 aletta da mm.5 dim. mm. 25x25 lungh. cm. 75	9,38
EU60A5100	Tubo quadro con 1 aletta da mm.5 dim. mm. 25x25 lungh. cm. 100	12,50
EU60A5150	Tubo quadro con 1 aletta da mm.5 dim. mm. 25x25 lungh. cm. 150	18,75
EU60A5200	Tubo quadro con 1 aletta da mm.5 dim. mm. 25x25 lungh. cm. 200	25,00
EU60A5300	Tubo quadro con 1 aletta da mm.5 dim. mm. 25x25 lungh. cm. 300	37,50

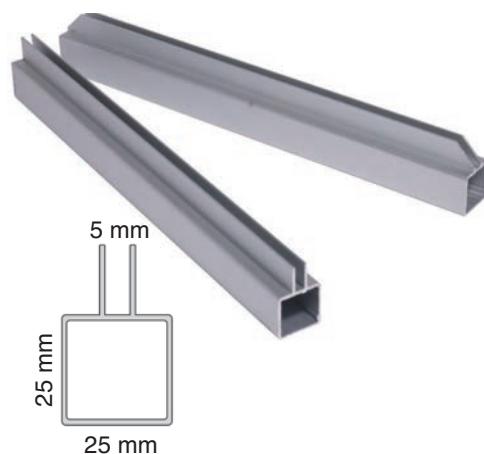

## SCHEDA TECNICA PROFILO QUADRO CON ALETTA 5 MM. TAGLIO 45°

Codice art.	Descrizione	L.P.
EU60A550U	Tubo quadro con 1 aletta da mm.5 dim. mm. 25x25 lungh. cm. 50 taglio a 45°	7,75
EU60A575U	Tubo quadro con 1 aletta da mm.5 dim. mm. 25x25 lungh. cm. 75 taglio a 45°	10,88
EU60A5100U	Tubo quadro con 1 aletta da mm.5 dim. mm. 25x25 lungh. cm. 100 taglio a 45°	14,00
EU60A5150U	Tubo quadro con 1 aletta da mm.5 dim. mm. 25x25 lungh. cm. 150 taglio a 45°	20,25
EU60A5200U	Tubo quadro con 1 aletta da mm.5 dim. mm. 25x25 lungh. cm. 200 taglio a 45°	26,50
EU60A5300U	Tubo quadro con 1 aletta da mm.5 dim. mm. 25x25 lungh. cm. 300 taglio a 45°	39,00

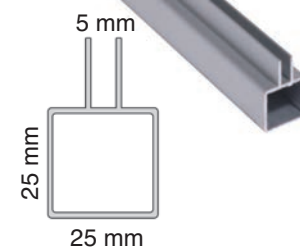

## SCHEDA TECNICA PROFILO QUADRO CON ALETTA 10 MM.

Codice art.	Descrizione	L.P.
EU60A1050	Tubo quadro con 1 aletta da mm.10 dim. mm. 25x25 lungh. cm. 50	6,25
EU60A1075	Tubo quadro con 1 aletta da mm.10 dim. mm. 25x25 lungh. cm. 75	9,38
EU60A10100	Tubo quadro con 1 aletta da mm.10 dim. mm. 25x25 lungh. cm. 100	12,50
EU60A10150	Tubo quadro con 1 aletta da mm.10 dim. mm. 25x25 lungh. cm. 150	18,75
EU60A10200	Tubo quadro con 1 aletta da mm.10 dim. mm. 25x25 lungh. cm. 200	25,00
EU60A10300	Tubo quadro con 1 aletta da mm.10 dim. mm. 25x25 lungh. cm. 300	37,50

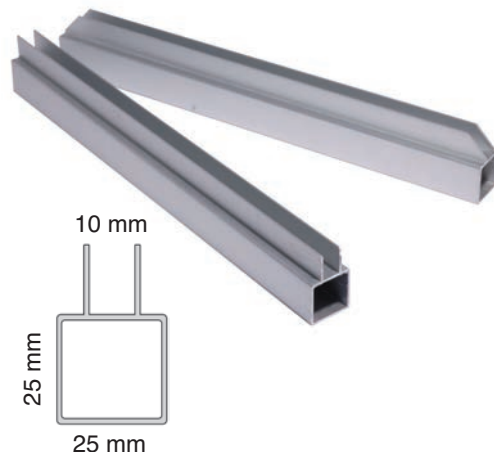

## SCHEDA TECNICA PROFILO QUADRO CON ALETTA 10 MM. TAGLIO 45°

Codice art.	Descrizione	L.P.
EU60A1050U	Tubo quadro con 1 aletta da mm.10 dim. mm. 25x25 lungh. cm. 50 taglio a 45°	7,75
EU60A1075U	Tubo quadro con 1 aletta da mm.10 dim. mm. 25x25 lungh. cm. 75 taglio a 45°	10,88
EU60A10100U	Tubo quadro con 1 aletta da mm.10 dim. mm. 25x25 lungh. cm. 100 taglio a 45°	14,00
EU60A10150U	Tubo quadro con 1 aletta da mm.10 dim. mm. 25x25 lungh. cm. 150 taglio a 45°	20,25
EU60A10200U	Tubo quadro con 1 aletta da mm.10 dim. mm. 25x25 lungh. cm. 200 taglio a 45°	26,50
EU60A10300U	Tubo quadro con 1 aletta da mm.10 dim. mm. 25x25 lungh. cm. 300 taglio a 45°	39,00

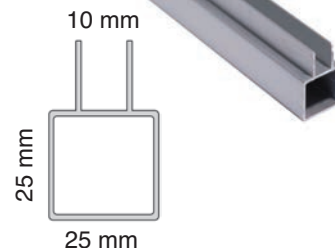

## SCHEDA TECNICA PROFILO QUADRO CON 2 ALETTE 5 MM.

Codice art.	Descrizione	L.P.
EU60C550	Tubo quadro con 2 alette ad angolo da mm.5 dim. mm. 25x25 lungh. cm. 50	8,24
EU60C575	Tubo quadro con 2 alette ad angolo da mm.5 dim. mm. 25x25 lungh. cm. 75	12,36
EU60C5100	Tubo quadro con 2 alette ad angolo da mm.5 dim. mm. 25x25 lungh. cm. 100	16,48
EU60C5150	Tubo quadro con 2 alette ad angolo da mm.5 dim. mm. 25x25 lungh. cm. 150	24,72
EU60C5200	Tubo quadro con 2 alette ad angolo da mm.5 dim. mm. 25x25 lungh. cm. 200	32,96
EU60C5300	Tubo quadro con 2 alette ad angolo da mm.5 dim. mm. 25x25 lungh. cm. 300	49,44

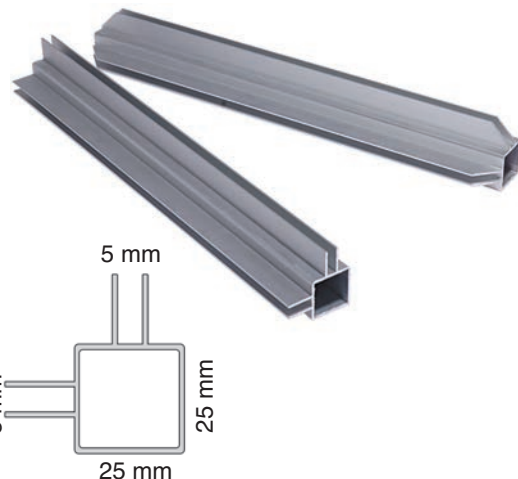

## SCHEDA TECNICA PROFILO QUADRO CON 2 ALETTE 5 MM. TAGLIO 45°

Codice art.	Descrizione	L.P.
EU60C550U	Tubo quadro con 2 alette ad angolo da mm.5 dim. mm. 25x25 lungh. cm. 50 taglio a 45°	11,24
EU60C575U	Tubo quadro con 2 alette ad angolo da mm.5 dim. mm. 25x25 lungh. cm. 75 taglio a 45°	15,36
EU60C5100U	Tubo quadro con 2 alette ad angolo da mm.5 dim. mm. 25x25 lungh. cm. 100 taglio a 45°	19,48
EU60C5150U	Tubo quadro con 2 alette ad angolo da mm.5 dim. mm. 25x25 lungh. cm. 150 taglio a 45°	27,72
EU60C5200U	Tubo quadro con 2 alette ad angolo da mm.5 dim. mm. 25x25 lungh. cm. 200 taglio a 45°	35,96
EU60C5300U	Tubo quadro con 2 alette ad angolo da mm.5 dim. mm. 25x25 lungh. cm. 300 taglio a 45°	52,44

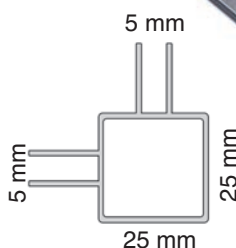



# PROFILI TECHNO

## SCHEDA TECNICA PROFILO QUADRO CON 2 ALETTE 5 MM.

Codice art.	Descrizione	L.P.
EU60B550	Tubo quadro con 2 alette contrapposte da mm.5 dim. mm. 25x25 lungh. cm. 50	8,24
EU60B575	Tubo quadro con 2 alette contrapposte da mm.5 dim. mm. 25x25 lungh. cm. 75	12,36
EU60B5100	Tubo quadro con 2 alette contrapposte da mm.5 dim. mm. 25x25 lungh. cm. 100	16,48
EU60B5150	Tubo quadro con 2 alette contrapposte da mm.5 dim. mm. 25x25 lungh. cm. 150	24,72
EU60B5200	Tubo quadro con 2 alette contrapposte da mm.5 dim. mm. 25x25 lungh. cm. 200	32,96
EU60B5300	Tubo quadro con 2 alette contrapposte da mm.5 dim. mm. 25x25 lungh. cm. 300	49,44

## SCHEDA TECNICA PROFILO QUADRO CON 2 ALETTE 5 MM. TAGLIO 45°

Codice art.	Descrizione	L.P.
EU60B550U	Tubo quadro con 2 alette contrapposte da mm.5 dim. mm. 25x25 lungh. cm. 50 taglio a 45°	11,24
EU60B575U	Tubo quadro con 2 alette contrapposte da mm.5 dim. mm. 25x25 lungh. cm. 75 taglio a 45°	15,36
EU60B5100U	Tubo quadro con 2 alette contrapposte da mm.5 dim. mm. 25x25 lungh. cm. 100 taglio a 45°	19,48
EU60B5150U	Tubo quadro con 2 alette contrapposte da mm.5 dim. mm. 25x25 lungh. cm. 150 taglio a 45°	27,72
EU60B5200U	Tubo quadro con 2 alette contrapposte da mm.5 dim. mm. 25x25 lungh. cm. 200 taglio a 45°	35,96
EU60B5300U	Tubo quadro con 2 alette contrapposte da mm.5 dim. mm. 25x25 lungh. cm. 300 taglio a 45°	52,44

## SCHEDA TECNICA PROFILO QUADRO CON 3 ALETTE 5 MM.

Codice art.	Descrizione	L.P.
EU60D550	Tubo quadro con 3 alette a "T" da mm.5 dim. mm. 25x25 lungh. cm. 50	9,50
EU60D575	Tubo quadro con 3 alette a "T" da mm.5 dim. mm. 25x25 lungh. cm. 75	14,25
EU60D5100	Tubo quadro con 3 alette a "T" da mm.5 dim. mm. 25x25 lungh. cm. 100	19,00
EU60D5150	Tubo quadro con 3 alette a "T" da mm.5 dim. mm. 25x25 lungh. cm. 150	28,50
EU60D5200	Tubo quadro con 3 alette a "T" da mm.5 dim. mm. 25x25 lungh. cm. 200	38,00
EU60D5300	Tubo quadro con 3 alette a "T" da mm.5 dim. mm. 25x25 lungh. cm. 300°	57,00

## SCHEDA TECNICA PROFILO QUADRO CON 3 ALETTE 5 MM. TAGLIO 45°

Codice art.	Descrizione	L.P.
EU60D550U	Tubo quadro con 3 alette a "T" da mm.5 dim. mm. 25x25 lungh. cm. 50 taglio a 45°	14,00
EU60D575U	Tubo quadro con 3 alette a "T" da mm.5 dim. mm. 25x25 lungh. cm. 75 taglio a 45°	18,75
EU60D5100U	Tubo quadro con 3 alette a "T" da mm.5 dim. mm. 25x25 lungh. cm. 100 taglio a 45°	23,50
EU60D5150U	Tubo quadro con 3 alette a "T" da mm.5 dim. mm. 25x25 lungh. cm. 150 taglio a 45°	33,00
EU60D5200U	Tubo quadro con 3 alette a "T" da mm.5 dim. mm. 25x25 lungh. cm. 200 taglio a 45°	42,50
EU60D5300U	Tubo quadro con 3 alette a "T" da mm.5 dim. mm. 25x25 lungh. cm. 300 taglio a 45°	61,50

## SCHEDA TECNICA PROFILO QUADRO CON ALETTA 5 MM.

Codice art.	Descrizione	L.P.
EU60L550	Tubo quadro con 1 aletta laterale da mm.5 lungh. cm.50	6,25
EU60L575	Tubo quadro con 1 aletta laterale da mm.5 lungh. cm.75	9,38
EU60L5100	Tubo quadro con 1 aletta laterale da mm.5 lungh. cm.100	12,50
EU60L5150	Tubo quadro con 1 aletta laterale da mm.5 lungh. cm.150	18,75
EU60L5200	Tubo quadro con 1 aletta laterale da mm.5 lungh. cm.200	25,00
EU60L5300	Tubo quadro con 1 aletta laterale da mm.5 lungh. cm.300	37,50

## SCHEDA TECNICA PROFILO QUADRO CON ALETTA 5 MM. TAGLIO 45°

Codice art.	Descrizione	L.P.
EU60L550U	Tubo quadro con 1 aletta laterale da mm.5 lungh. cm.50 angolo 45°	7,75
EU60L575U	Tubo quadro con 1 aletta laterale da mm.5 lungh. cm.75 angolo 45°	10,88
EU60L5100U	Tubo quadro con 1 aletta laterale da mm.5 lungh. cm.100 angolo 45°	14,00
EU60L5150U	Tubo quadro con 1 aletta laterale da mm.5 lungh. cm.150 angolo 45°	20,25
EU60L5200U	Tubo quadro con 1 aletta laterale da mm.5 lungh. cm.200 angolo 45°	26,50
EU60L5300U	Tubo quadro con 1 aletta laterale da mm.5 lungh. cm.300 angolo 45°	39,00

## SCHEDA TECNICA PROFILO QUADRO CON 2 ALETTE 5 MM.

Codice art.	Descrizione	L.P.
EU602L550	Tubo quadro con 2 alette laterali da mm.5 lungh. cm.50	8,24
EU602L575	Tubo quadro con 2 alette laterali da mm.5 lungh. cm.75	12,36
EU602L5100	Tubo quadro con 2 alette laterali da mm.5 lungh. cm.100	16,48
EU602L5150	Tubo quadro con 2 alette laterali da mm.5 lungh. cm.150	24,72
EU602L5200	Tubo quadro con 2 alette laterali da mm.5 lungh. cm.200	32,96
EU602L5300	Tubo quadro con 2 alette laterali da mm.5 lungh. cm.300	49,44

## SCHEDA TECNICA PROFILO QUADRO CON 2 ALETTE 5 MM. TAGLIO 45°

Codice art.	Descrizione	L.P.
EU602L550U	Tubo quadro con 2 alette laterali da mm.5 lungh. cm.50 angolo 45°	11,24
EU602L575U	Tubo quadro con 2 alette laterali da mm.5 lungh. cm.75 angolo 45°	15,36
EU602L5100U	Tubo quadro con 2 alette laterali da mm.5 lungh. cm.100 angolo 45°	19,58
EU602L5150U	Tubo quadro con 2 alette laterali da mm.5 lungh. cm.150 angolo 45°	27,72
EU602L5200U	Tubo quadro con 2 alette laterali da mm.5 lungh. cm.200 angolo 45°	35,96
EU602L5300U	Tubo quadro con 2 alette laterali da mm.5 lungh. cm.300 angolo 45°	52,44

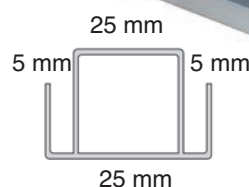
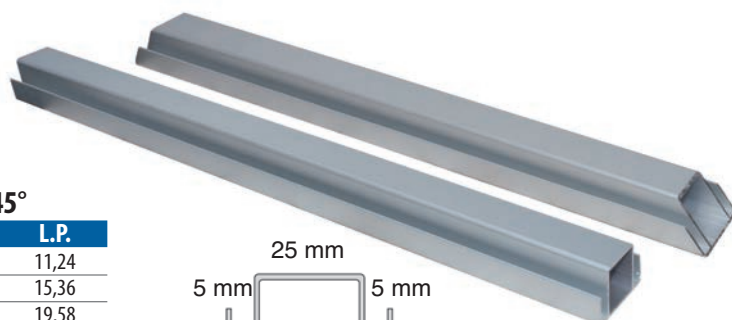
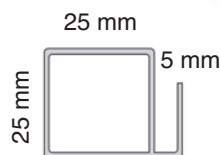
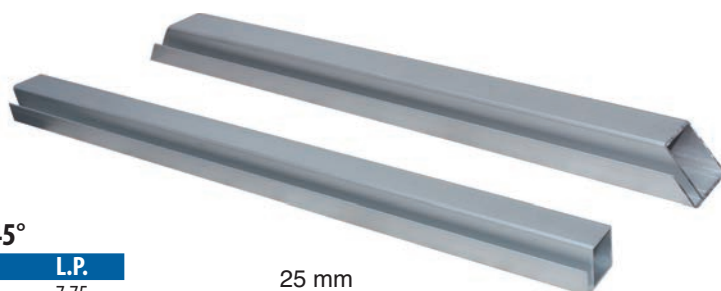
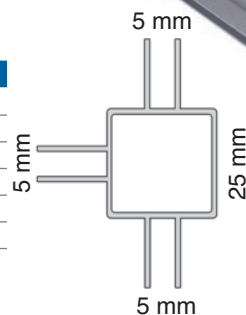
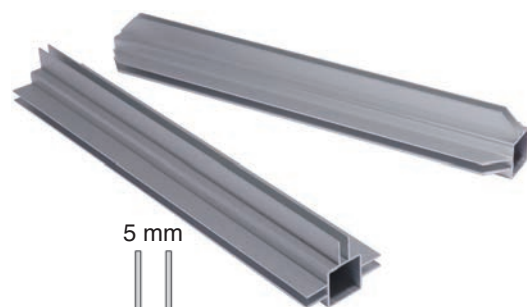
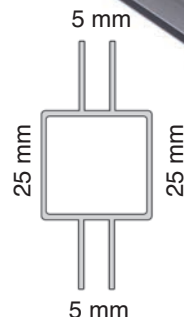
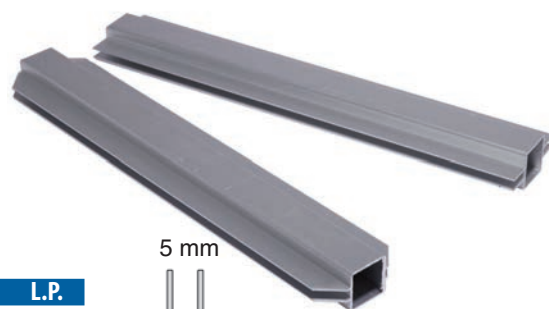



AMAM1125



AMAMR1125  
(angolotondo)



AMAM12025 (120°)



AMAM13525 (135°)



AMAM15025 (150°)



AMAM7725



AMAM2225



AMAM4125



AMAMR4125  
(angolotondo)



AMAM3325



AMAM5225



AMAM6325



AMAM6625



AMAMBASE



AMAM125



AMAM90



AMAM88-1



AMAM90-2



AMAMARAB



SNAM11PL



SNAM22PL



SNAM41PL



SNAM52PL

## SCHEDA TECNICA GIUNTI IN METALLO

Codice art.	Descrizione	L.P.
AMAM1125	Giunto in metallo a 2 vie angolo 90°	7,68
AMAMR1125	Giunto in metallo a 2 vie angolo tondo	8,80
AMAM12025	Giunto in metallo a 2 vie angolo 120°	12,66
AMAM13525	Giunto in metallo a 2 vie angolo 135°	12,66
AMAM15025	Giunto in metallo a 2 vie angolo 150°	12,66
AMAM7725	Giunto in metallo a 2 vie in linea	14,00
AMAM2225	Giunto in metallo a 3 vie a "T"	8,52
AMAM3325	Giunto in metallo a 4 vie a croce	10,92
AMAM4125	Giunto in metallo a 3 vie ad angolo	9,80
AMAMR4125	Giunto in metallo a 3 vie angolo tondo	12
AMAM5225	Giunto in metallo a 4 vie	10,48
AMAM6325	Giunto in metallo a 5 vie	11,88
AMAM6625	Giunto in metallo a 6 vie	16,12
AMAMBASE	Base in metallo con innesto per tubi	32,00

## SCHEDA TECNICA GIUNTI IN PLASTICA

Codice art.	Descrizione	L.P.
AMAMARAB	Giunto in plastica regolabile	7,60
SNAM11PL	Giunto in plastica a 2 vie angolo 90°	3,84
SNAM22PL	Giunto in plastica a 3 vie a "T"	4,26
SNAM41PL	Giunto in plastica a 3 vie ad angolo	4,90
SNAM52PL	Giunto in plastica a 4 vie	5,24
AMAM125	Cestello in plastica per innesto giunti	0,42
AMAM90	Tappo in plastica per profilo	1,00
AMAM88-1	Tappo in plastica per profilo con filettatura	1,00
AMAM90-2	Tappo-piede in plastica per profilo	1,00

# QUADROTRATTO

Pannello in Kapa Tex effetto tela, tagliato e inciso sul posteriore per essere piegato e fissato con biadesivo per formare una cornice; stampabile con UV Curabile, disponibile in varie misure standard.

Panel in Kapa Tex canvas effect, cut and engraved on the back to be folded and secured with double sided tape to form a frame; printable with UV Curable, available in various standard sizes.

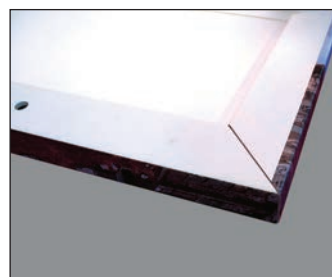
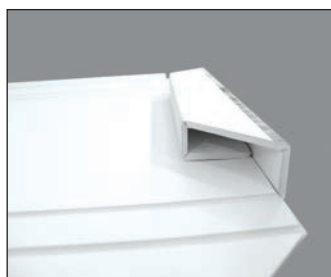
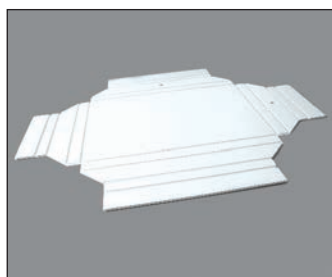
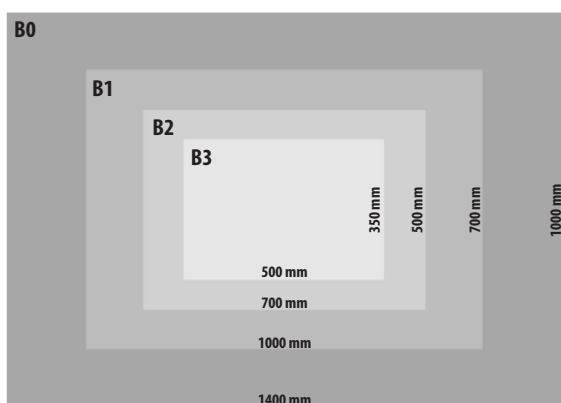
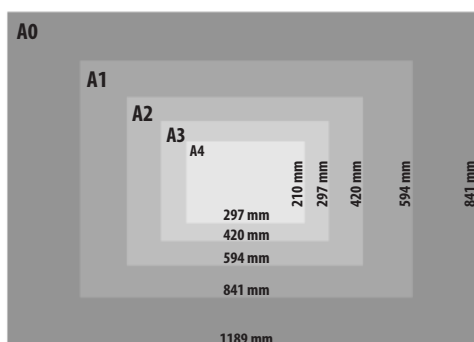

## SCHEDA TECNICA

Codice art.	Misure cm.	Grafica cm.	L.P.
EUQTRAA4	A4	29,7x21	13
EUQTRAA3	A3	42x29,7	22
EUQTRAA2	A2	59,4x42	40
EUQTRAA1	A1	84,1x59,4	65
EUQTRAA0	A0	1189x841	120
EUQTRAB3	B3	50x35	33
EUQTRAB2	B2	70x50	55
EUQTRAB1	B1	100x70	70
EUQTRAB0	B0	140x100	150

# CASSONETTI LUMINOSI MONOFACCIALI



**REALIZZAMO SU RICHIESTA CASSONETTI MONOFACCIALI SU MISURA:** È NECESSARIO CHE CI COMUNICHiate SOLTANTO LA QUANTITÀ DESIDERATA ED IL FORMATO, DOPODI CHÉ IN MENO DI 24 ORE IL VOSTRO PREVENTIVO PERSONALIZZATO SARÀ PRONTO. È POSSIBILE SCEGLIERE IL PROFILO SIA NELLA VARIANTE ARGENTO SILVER CHE IN QUELLA NERA OPACA, DISPONIBILI ENTRAMBE IN 3 DIVERSE LARGHEZZE: MM 80, MM 120 E MM 150. LE DIMENSIONI STANDARD VANNO DA UN MINIMO DI CM 50 AD UN MASSIMO DI CM 600 PER LA LUNGHEZZA, E DA UN MINIMO DI CM 50 AD UN MASSIMO DI CM 200 PER L'ALTEZZA.

## COMPONENTISTICA DI MONTAGGIO

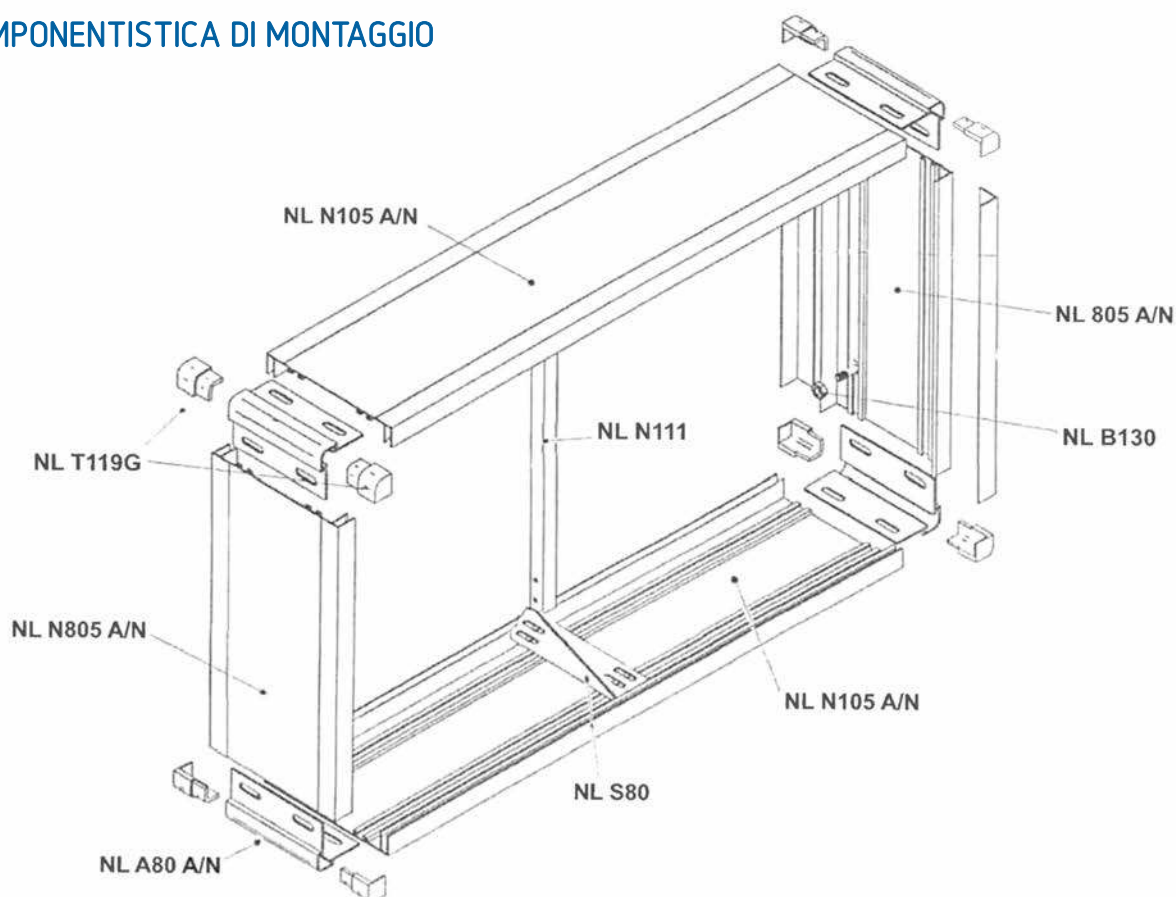

## SI CONSIGLIA UTILIZZO DEI SEGUENTI MODULI LED

### SCHEDA TECNICA HM1 POWER ALUX

Codice art.	Colore Led	CCT / $\lambda d$	Flusso Luminoso	Efficienza	Pz. Conf.
M1P70	bianco freddo - cool white	5500/7000 K	125 lumens	83.3 Lm/w	2x30

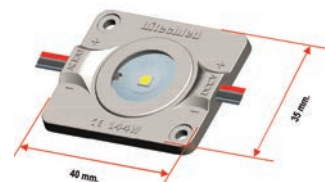

# ISTRUZIONI DI MONTAGGIO



Taglio profilo

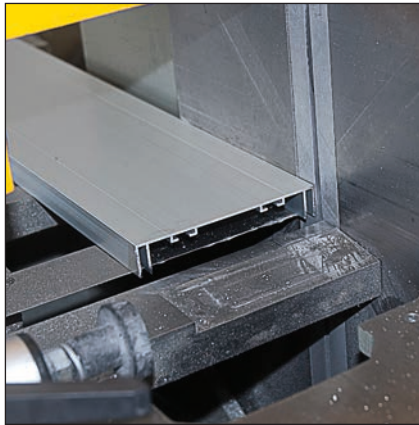

Sezione profilo



Fissaggio fazzoletti



Taglio tubo portalampada



Fissaggio portalampada a fazzoletti



Scheletro cassonetto

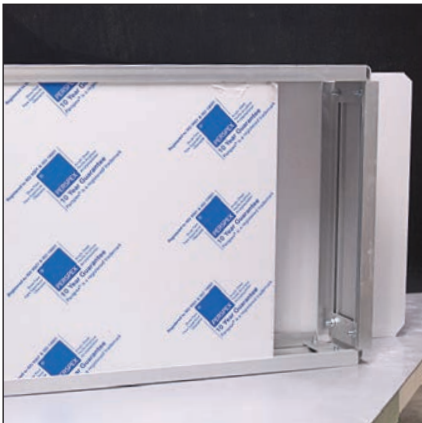

Inserimento pannello in plexiglass



Fissaggio cornice angolare



Fissaggio tappi in plastica

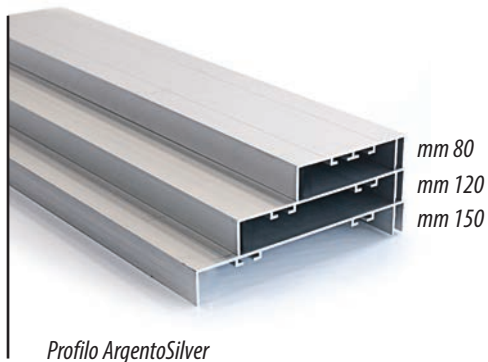

Profilo ArgentoSilver



Profilo Nero Opaco

# CASSONETTI LUMINOSI BIFACCIALI



**REALIZZAMO SU RICHIESTA CASSONETTI BIFACCIALI SU MISURA:** È NECESSARIO CHE CI COMUNICHiate SOLTANTO LA QUANTITÀ DESIDERATA ED IL FORMATO, DOPODI CHÉ IN MENO DI 24 ORE IL VOSTRO PREVENTIVO PERSONALIZZATO SARÀ PRONTO. È POSSIBILE SCEGLIERE IL PROFILO SIA NELLA VARIANTE ARGENTO SILVER CHE IN QUELLA NERA OPACA, DISPONIBILI ENTRAMBE IN 3 DIVERSE LARGHEZZE: MM 80, MM 120 E MM 150. LE DIMENSIONI STANDARD VANNO DA UN MINIMO DI CM 40 AD UN MASSIMO DI CM 120 PER LA LUNGHEZZA, E DA UN MINIMO DI CM 40 AD UN MASSIMO DI CM 200 PER L'ALTEZZA.

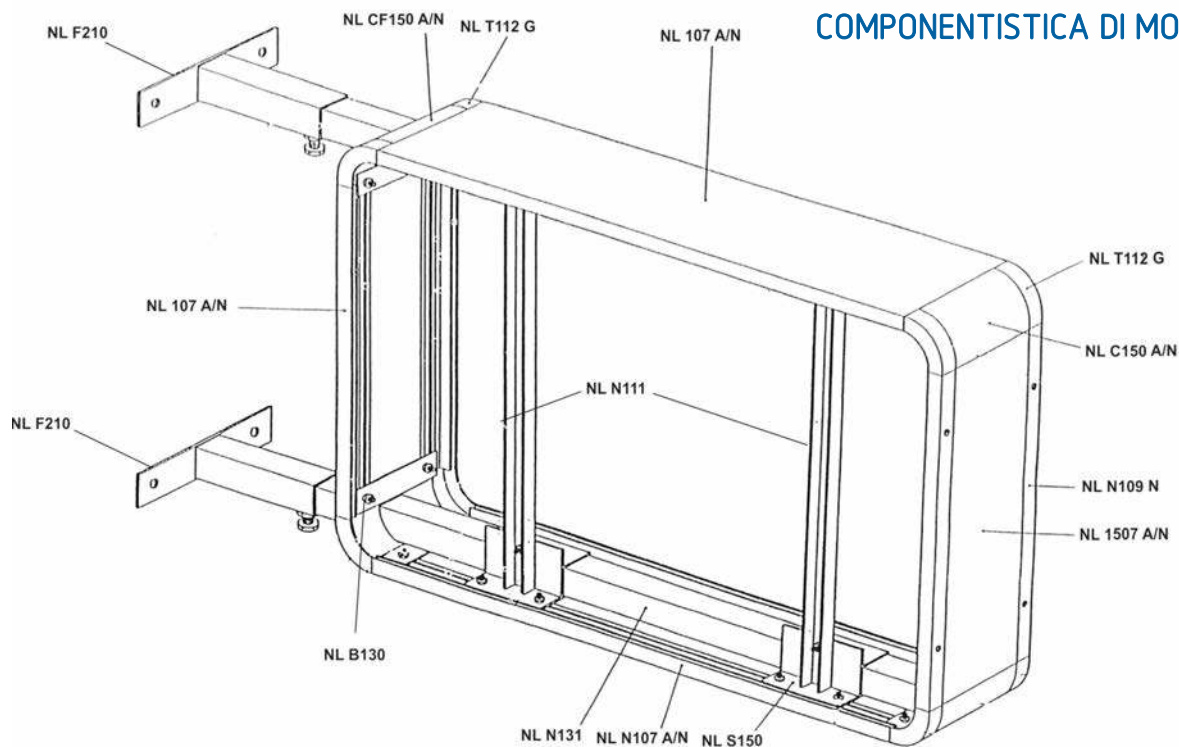

## COMPONENTISTICA DI MONTAGGIO

### SI CONSIGLIA UTILIZZO DEI SEGUENTI MODULI LED

#### SCHEDA TECNICA HM1LD POWER ALUX PER INSEGNE BIFACCIALI

Codice art.	Colore Led	CCT / λd	Flusso Luminoso	Efficienza	Pz. Conf.
HM1LD65	bianco freddo - cool white	6500/7000 K	129 Lumens	86 Lm/w	60

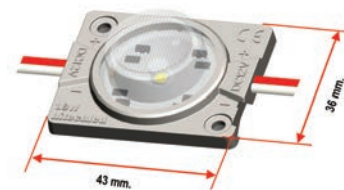

#### SCHEDA TECNICA HM1LDP POWER PER INSEGNE BIFACCIALI

Codice art.	Colore	CCT / λd	Flusso Luminoso	Efficienza	Pz. Conf.
HM1LDP65	bianco freddo - cool white	6500/7000 K	244 Lumens	87 Lm/w	20



# ISTRUZIONI DI MONTAGGIO



Taglio profilo



Fissaggio fazzoletti

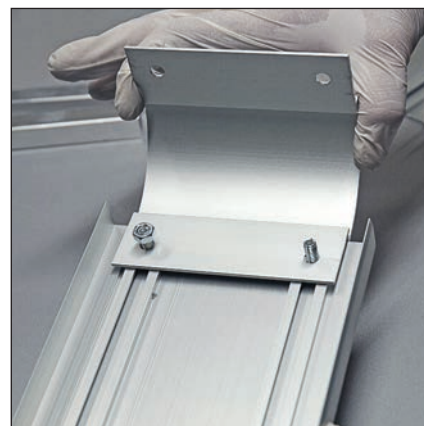

Fissaggio angolare anteriore

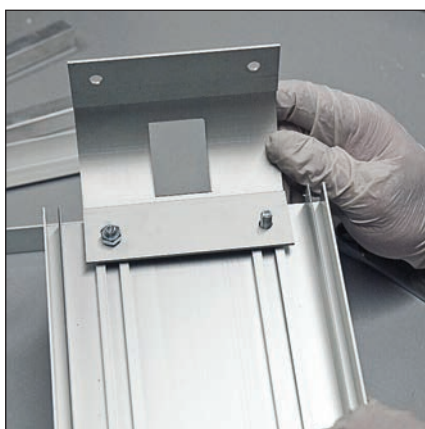

Fissaggio angolare per staffa



Fissaggio tubo quadri 30x30 per staffa

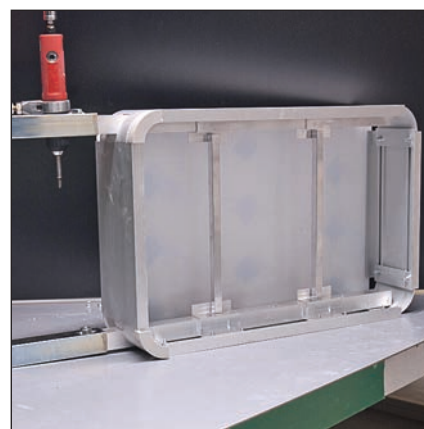

Scheletro cassonetto



Taglio tubo portalamпада

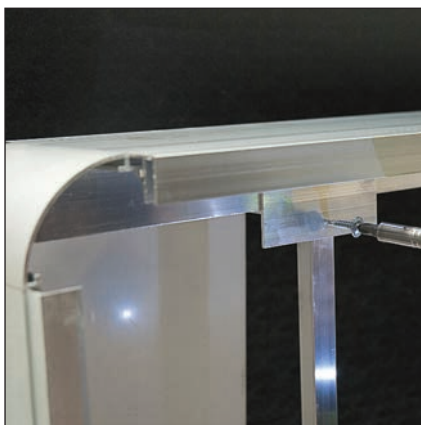

Fissaggio tubo portalamпада

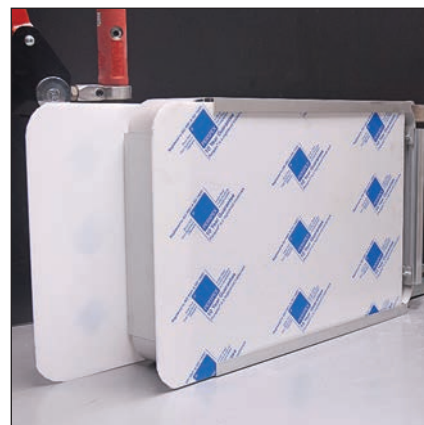

Inserimento pannelli in plexiglass



Profilo ArgentoSilver

mm 80  
mm 120  
mm 150

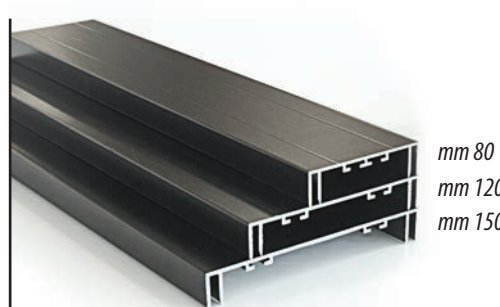

Profilo Nero Opaco

mm 80  
mm 120  
mm 150



Serie di punte di ricambio per macchinari CNC, a seconda della tipologia è possibile tagliare o incidere diversi materiali come pvc espanso, acrilico, alluminio composito e non, kapatex, pannelli sandwich, kartoon, ecc. Per ogni tipologia sono disponibili diverse misure.

Replacement sharps for CNC machinery, depending on the kind it is possible cutting several materials such as pvc foam, acrylic, composite and pure aluminum, kapatex, sandwich sheets, kartoon, etc. For each one are available different sizes.



## SCHEDA TECNICA PUNTE PER PER INCISIONI SU DIBOND (ALLUMINIO COMPOSITO)

Codice art.	V	d	D	L	X	L.P.
NGACM1064590	90°	10,0	6	45	1,8	163
NGB2ACM15659120	120°	15	6	50	1,8	224
NGB2ACM155650135	135°	15,5	6	50	1,8	249

## SCHEDA TECNICA PUNTE PER PVC ESPANSO (FOREX)

Codice art.	d	D	I	L	L.P.
NGS126650MP	2,0	6	6	50	60
NGS136650MP	3,0	6	6	50	55
NGS146650MP	4,0	6	6	50	55
NGS1442250MP	4,0	4	22	50	47,50
NGS1661250MP	6,0	6	12	50	55
NGS1663264MP	6,0	6	32	64	66

## SCHEDA TECNICA PUNTE PER ACRILICO PERSPEX

Codice art.	d	D	I	L	L.P.
NGS126650A	2,0	6	6	50	62
NGS136650A	3,0	6	6	50	62
NGS146850A	4,0	6	6	50	65
NGS1661250A	6,0	6	12	50	61

## SCHEDA TECNICA PUNTE PER DIBOND E LAMINA DI ALLUMINIO \*

Codice art.	d	D	I	L	L.P.
NGS1331138MPDLC	3,0	3	11	38	46
NGS126650MPDLC	2,0	6	6	50	89
NGS136650MPDLC	3,0	6	6	50	89
NGS146650MPDLC	4,0	6	6	50	89
NGS1441250MPDLC	4,0	4	12	50	51,50
NGS1661250MPDLC	6,0	6	12	50	89
NGS1662260MPDLC	6,0	6	22	60	68,50

\*ANCHE PER ALLUMINIO SENZA RAFFREDDARE

## SCHEDA TECNICA PUNTE SUPERIOR (TUTTI I MATERIALI)

Codice art.	d	D	I	L	L.P.
NGS126650MPSUP	2,0	6	6	50	130
NGS136650MPSUP	3,0	6	6	50	130
NGS146650MPSUP	4,0	6	6	50	130
NGS1661250MPSUP	6,0	6	12	50	130
NGS1883264MPSUP	8,0	8	32	64	105
NGS10103276MPSUP	10,0	10	32	76	122

## SCHEDA TECNICA PUNTE SPINGENTI PER PVC ESPANSO (FOREX) E DIBOND

Codice art.	d	D	I	L	L.P.
NGS1331138MPDC	3,0	3	11	38	46
NGS1441250MPDC	4,0	4	12	50	51,60
NGS1662260MPDC	6,0	6	22	60	68,60

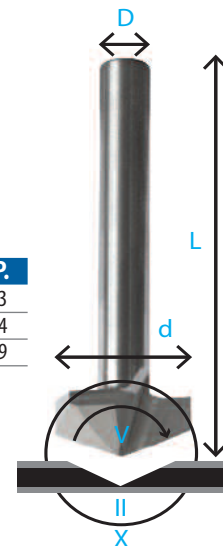



# LETTERE A SPECCHIO

Lettere realizzate in Perspex nero o trasparente, intagliate al laser, perimetro a filo lucido, con superficie rivestita con film adesivo a specchio. Disponibile nello spessore di mm. 10, di dimensioni standard come da tabella riportata di seguito.

*Black or transparent Perspex letters, laser cut with gloss perimeter and surface covered with mirror adhesive. Available with mm. 10 thickness, standard size as shown in the following table.*



## SCHEDA TECNICA

Cod. art.	Descrizione	Spess. mm.	L.P.
EULEPX2020TS	Lettere in Perspex trasparente+film specchio mod. "A" cm. 20x20	10	38
EULEPX2525TS	Lettere in Perspex trasparente+film specchio mod. "B" cm. 25x25	10	55
EULEPX3030TS	Lettere in Perspex trasparente+film specchio mod. "C" cm. 30x30	10	87
EULEPX3535TS	Lettere in Perspex trasparente+film specchio mod. "D" cm. 35x35	10	116
EULEPX4040TS	Lettere in Perspex trasparente+film specchio mod. "E" cm. 40x40	10	154
EULEPX5050TS	Lettere in Perspex trasparente+film specchio mod. "F" cm. 50x50	10	190
EULEPX2020NS	Lettere in Perspex nero+film specchio mod. "A" cm. 20x20	10	42
EULEPX2525NS	Lettere in Perspex nero+film specchio mod. "B" cm. 25x25	10	65
EULEPX3030NS	Lettere in Perspex nero+film specchio mod. "C" cm. 30x30	10	96
EULEPX3535NS	Lettere in Perspex nero +film specchio mod. "D" cm. 35x35	10	128
EULEPX4040NS	Lettere in Perspex nero +film specchio mod. "E" cm. 40x40	10	170
EULEPX5050NS	Lettere in Perspex nero +film specchio mod. "F" cm. 50x50	10	210

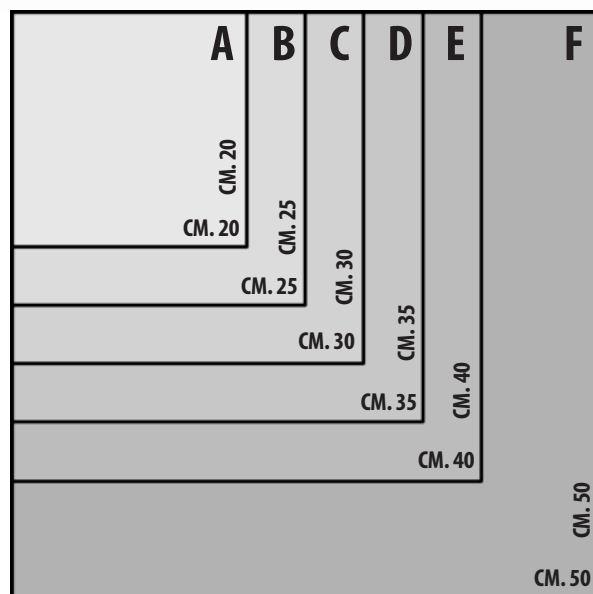

# PANNELLI RASTERIZZATI

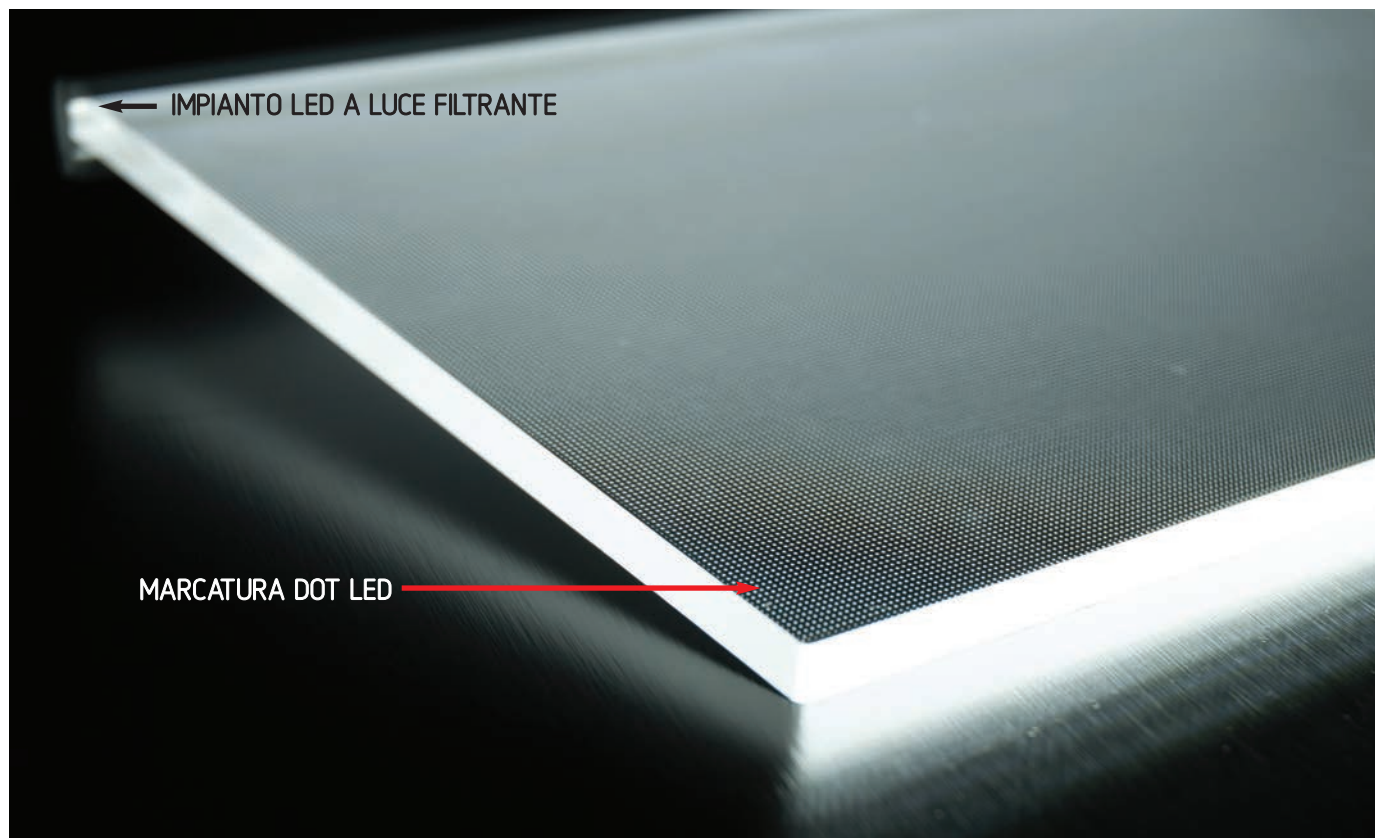

Le nuove tecnologie a disposizione di Eurmoma, consentono di realizzare pannelli in Perspex trasparente incisi con tecnica dot; nello specifico, il raggio laser incide dei minuscoli punti distribuendoli sulla superficie secondo un sofisticato algoritmo, formando lettere o loghi. Questi punti, opportunamente illuminati sul perimetro del pannello, danno vita a sagome o pannelli luminosi, lasciando integra la trasparenza del materiale. Disponibili in formati standard, come da schema, ed in altre dimensioni a richiesta.

*New technologies are available for Eurmoma, which allow to realize clear Perspex panels incised through dot technique; in particular, laser ray incises tiny dots distributing on the surface with a sophisticated algorithm, molding letters or logos. These dots, opportunely illuminated in the panel perimeter, give life to shapes or bright panels, leaving whole the material transparency. Available in standard sizes, as shown in the scheme, and in other sizes upon request.*

## SCHEMA TECNICA

Cod. art.	Descrizione	Spess. mm.	L.P.
EUPX82020R	Pannello rasterizzato in Perspex trasparente mod. "A" cm. 20x20	8	10
EUPX82525R	Pannello rasterizzato in Perspex trasparente mod. "B" cm. 25x25	8	13
EUPX83030R	Pannello rasterizzato in Perspex trasparente mod. "C" cm. 30x30	8	23
EUPX83535R	Pannello rasterizzato in Perspex trasparente mod. "D" cm. 35x35	8	32
EUPX84040R	Pannello rasterizzato in Perspex trasparente mod. "E" cm. 40x40	8	36
EUPX85050R	Pannello rasterizzato in Perspex trasparente mod. "F" cm. 50x50	8	51

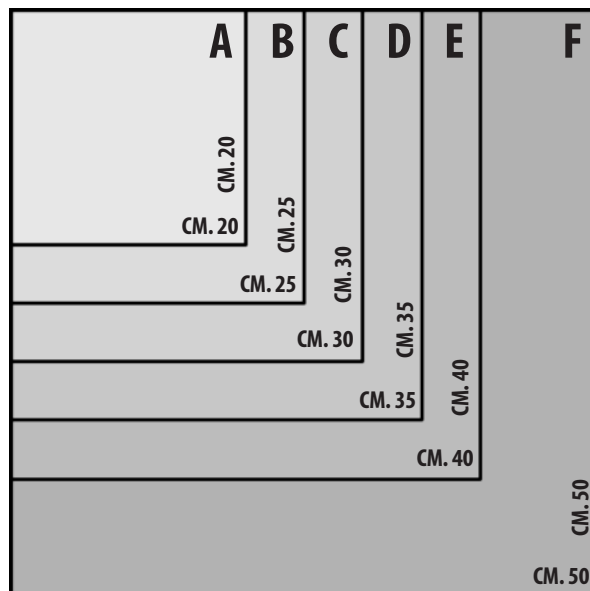

Grazie alle macchine da taglio a controllo numerico, realizziamo un servizio esclusivo dedicato agli operatori del settore. Con il PVC espanso bianco SIMONA, negli spessori da mm. 10, mm.15, mm.19 e mm.30, realizziamo lettere per la costruzione di insegne; l'alta qualità del PVC espanso SIMONA garantisce un'ottima resistenza nel tempo ed è verniciabile con tinte acriliche, facilmente reperibili in commercio. Le lettere potranno essere di qualsiasi carattere da Voi scelto, mentre le dimensioni della singola lettera dovranno essere incluse all'interno dei formati standard, come riportato nella tabella di seguito.

*Thanks to CNC machinery, we realize an exclusive service for the sector operators. With white PVC foam SIMONA, available with the thickness of mm. 10, mm. 19 and mm. 30, we realize letters for the building of signboard; the high quality PVC foam SIMONA ensure an excellent resistance in time and it is paintable with achrylic paints easily available in the market. The letters can be of whatever colour you choose, while the sizes of the singular letter must be included in the standard ones, as shown in the following list.*

<b>A</b>	<b>B</b>	<b>C</b>	<b>D</b>	<b>E</b>	<b>F</b>
CM. 20	CM. 25	CM. 30	CM. 35	CM. 40	CM. 50
CM. 20	CM. 25	CM. 30	CM. 35	CM. 40	CM. 50
CM. 25	CM. 30	CM. 35	CM. 40	CM. 50	CM. 50
CM. 30	CM. 35	CM. 40	CM. 50	CM. 50	CM. 50
CM. 35	CM. 40	CM. 50	CM. 50	CM. 50	CM. 50
CM. 40	CM. 50	CM. 50	CM. 50	CM. 50	CM. 50
CM. 50	CM. 50	CM. 50	CM. 50	CM. 50	CM. 50



## LETTERE IN PVC ESPANSO

Cod. art.	Descrizione	Spessore mm.	L.P.
EULEPV102020	Lettera in PVC mod. "A" dim. cm. 20x20	10	25
EULEPV152020	Lettera in PVC mod. "A" dim. cm. 20x20	15	32
EULEPV192020	Lettera in PVC mod. "A" dim. cm. 20x20	19	35
EULEPV302020	Lettera in PVC mod. "A" dim. cm. 20x20	30	64
EULEPV102525	Lettera in PVC mod. "B" dim. cm. 25x25	10	27
EULEPV152525	Lettera in PVC mod. "B" dim. cm. 25x25	15	35
EULEPV192525	Lettera in PVC mod. "B" dim. cm. 25x25	19	38
EULEPV302525	Lettera in PVC mod. "B" dim. cm. 25x25	30	70
EULEPV103030	Lettera in PVC mod. "C" dim. cm. 30x30	10	30
EULEPV153030	Lettera in PVC mod. "C" dim. cm. 30x30	15	39
EULEPV193030	Lettera in PVC mod. "C" dim. cm. 30x30	19	42
EULEPV303030	Lettera in PVC mod. "C" dim. cm. 30x30	30	78
EULEPV103535	Lettera in PVC mod. "D" dim. cm. 35x35	10	35
EULEPV153535	Lettera in PVC mod. "D" dim. cm. 35x35	15	45
EULEPV193535	Lettera in PVC mod. "D" dim. cm. 35x35	19	49
EULEPV303535	Lettera in PVC mod. "D" dim. cm. 35x35	30	90
EULEPV104040	Lettera in PVC mod. "E" dim. cm. 40x40	10	40
EULEPV154040	Lettera in PVC mod. "E" dim. cm. 40x40	15	52
EULEPV194040	Lettera in PVC mod. "E" dim. cm. 40x40	19	56
EULEPV304040	Lettera in PVC mod. "E" dim. cm. 40x40	30	104
EULEPV105050	Lettera in PVC mod. "F" dim. cm. 50x50	10	45
EULEPV155050	Lettera in PVC mod. "F" dim. cm. 50x50	15	58
EULEPV195050	Lettera in PVC mod. "F" dim. cm. 50x50	19	62
EULEPV305050	Lettera in PVC mod. "F" dim. cm. 50x50	30	117

# LETTERE PER RETROILLUMINAZIONE

## IN PVC ESPANSO **SIMONA**

Kit realizzato con PVC espanso bianco SIMONA composto da lettera frontale, realizzata negli spessori da mm.19 o mm.30, lettera di fondo in PVC espanso bianco da mm.10 e distanziatori in PVC bianco. La lettera frontale, di spessore mm.19 o mm.30, sarà scavata nel suo retro (spazio opportuno per l'alloggiamento dei led), lasciando inalterato lo spessore nel perimetro; saranno realizzate delle aree dedicate al fissaggio del fondo, mediante distanziali. La lettera di fondo, di spessore mm.10, sarà maggiorata di mm.20 dall'outline della lettera frontale, e presenterà anche dei fori corrispondenti alle aree di fissaggio per l'assemblaggio a quest'ultima. Il kit si completa con i distanziali in PVC che garantiscono, mediante vite (non fornita), l'assemblaggio del tutto. L'alta qualità del PVC espanso SIMONA, garantisce un'ottima resistenza nel tempo ed è verniciabile con tinte acriliche, facilmente reperibili in commercio. Le lettere potranno essere di qualsiasi carattere da Voi scelto, mentre le dimensioni della singola lettera dovranno essere incluse all'interno dei formati standard, come riportato nella tabella di seguito.

*Kit realized with white SIMONA PVC foam composed of front letter thickness mm. 19 or mm. 30, back letter in white PVC foam thickness mm. 10 and white PVC spacers. The front letter, thickness mm. 10 or mm. 30, is digged on the back (to make possible the LED mounting), leaving the perimeter thickness unchanged; its back will be fixed in special areas with spacers. The back letter, thickness mm. 10, will be increased of mm. 20 from the front letter outline, and will have fixing*

*holes. The kit provides PVC spacers too, which ensure the assembly of the all kit through screws (not included). The high quality PVC foam SIMONA ensure an excellent resistance in time and it is paintable with achrylic paints easily available in the market.*

*The letters can be of whatever colour you choose, while the sizes of the singular letter must be included in the standard ones, as shown in the following list.*

A	B	C	D	E	F
CM. 20	CM. 25	CM. 30	CM. 35	CM. 40	CM. 50
CM. 20	CM. 25	CM. 30	CM. 35	CM. 40	CM. 50
CM. 20	CM. 25	CM. 30	CM. 35	CM. 40	CM. 50
CM. 20	CM. 25	CM. 30	CM. 35	CM. 40	CM. 50
CM. 20	CM. 25	CM. 30	CM. 35	CM. 40	CM. 50
CM. 20	CM. 25	CM. 30	CM. 35	CM. 40	CM. 50
CM. 20	CM. 25	CM. 30	CM. 35	CM. 40	CM. 50
CM. 20	CM. 25	CM. 30	CM. 35	CM. 40	CM. 50
CM. 20	CM. 25	CM. 30	CM. 35	CM. 40	CM. 50
CM. 20	CM. 25	CM. 30	CM. 35	CM. 40	CM. 50



### LETTERE IN PVC ESPANSO SPESSORI MM.19, MM.30

Cod. art.	Descrizione	Spessore Frontale mm	Spessore Fondo mm.	L.P.
EULRPV192020	Lettera in PVC mod. "A" dim. cm. 20x20 + Lettera di fondo + distanziali	19	10	75
EULRPV302020	Lettera in PVC mod. "A" dim. cm. 20x20 + Lettera di fondo + distanziali	30	10	109
EULRPV192525	Lettera in PVC mod. "B" dim. cm. 25x25 + Lettera di fondo + distanziali	19	10	82
EULRPV302525	Lettera in PVC mod. "B" dim. cm. 25x25 + Lettera di fondo + distanziali	30	10	120
EULRPV193030	Lettera in PVC mod. "C" dim. cm. 30x30 + Lettera di fondo + distanziali	19	10	92
EULRPV303030	Lettera in PVC mod. "C" dim. cm. 30x30 + Lettera di fondo + distanziali	30	10	135
EULRPV193535	Lettera in PVC mod. "D" dim. cm. 35x35 + Lettera di fondo + distanziali	19	10	107
EULRPV303535	Lettera in PVC mod. "D" dim. cm. 35x35 + Lettera di fondo + distanziali	30	10	156
EULRPV194040	Lettera in PVC mod. "E" dim. cm. 40x40+ Lettera di fondo + distanziali	19	10	122
EULRPV304040	Lettera in PVC mod. "E" dim. cm. 40x40 + Lettera di fondo + distanziali	30	10	179
EULRPV195050	Lettera in PVC mod. "F" dim. cm. 50x50 + Lettera di fondo + distanziali	19	10	135
EULRPV305050	Lettera in PVC mod. "F" dim. cm. 50x50 + Lettera di fondo + distanziali	30	10	200

### ESEMPIO INSTALLAZIONE

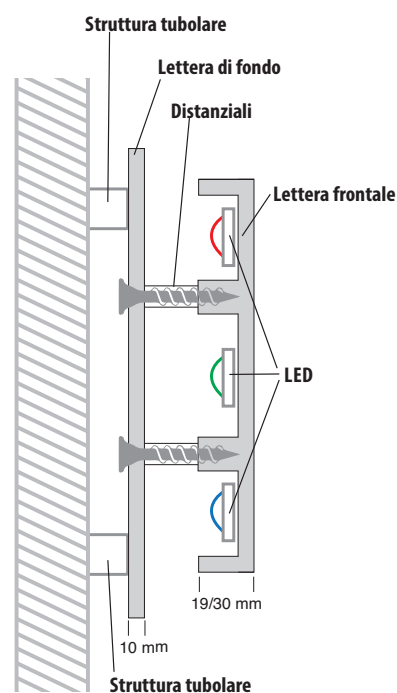



# FONDALI E PARETI

CROWN  
POP-UP TEXTILE  
POP-UP POLIONDA  
FISARMONICA CLASSIC E SEPARÈ  
THE WALL  
POP-UP QUICK FIX  
RICAMBI E ACCESSORI POP-UP  
SUPPORTI POP-UP



# CROWN

Soluzione leggera dedicata all'allestimento di stand in molteplici composizioni diverse; realizzato in alluminio con componenti in acciaio, è facile da montare, smontare e trasportare. Le pareti possono essere allestite con banner leggeri.

*Lightweight solution dedicated to the preparation stand in many different compositions; made of aluminum with steel components, it is easy to assemble, disassemble and carry. The walls can be set up with banners light.*



## Progetta il tuo allestimento

Consulta il sito [www.eurmoma.it](http://www.eurmoma.it) e tramite un software, potrai comporre il tuo stand personalizzato



## COMPONENTI STRUTTURA

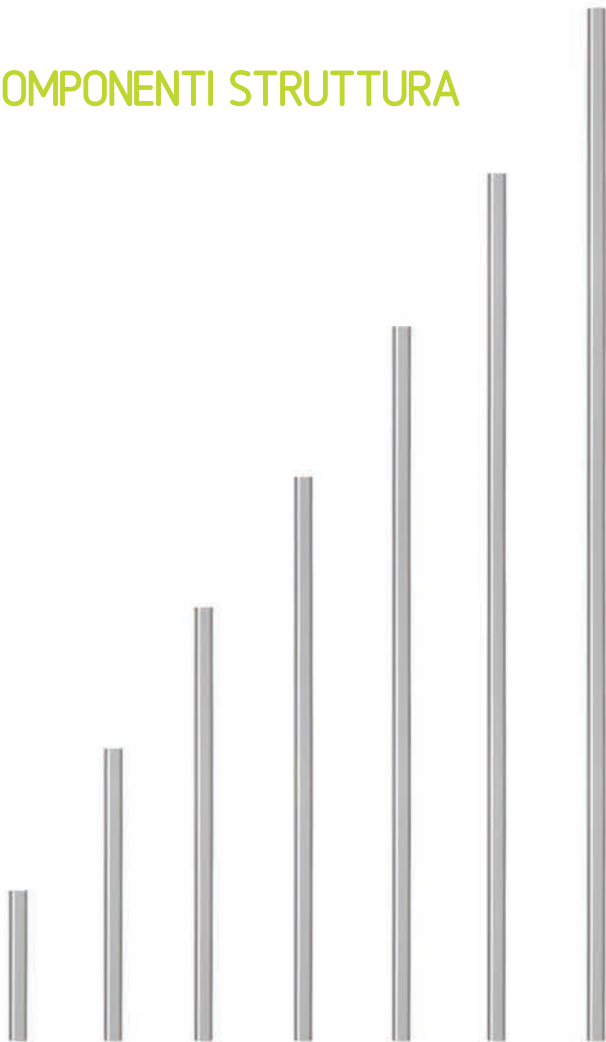

### SCHEDA TECNICA

Codice art.	Descrizione	L.P
MTCRPR30	Crown profilo alluminio per banner lunghezza cm.30	2
MTCRPR60	Crown profilo alluminio per banner lunghezza cm.60	4
MTCRPR90	Crown profilo alluminio per banner lunghezza cm.90	6
MTCRPR120	Crown profilo alluminio per banner lunghezza cm.120	9
MTCRPR150	Crown profilo alluminio per banner lunghezza cm.150	10
MTCRPR180	Crown profilo alluminio per banner lunghezza cm.180	12
MTCRPR210	Crown profilo alluminio per banner lunghezza cm.210	14

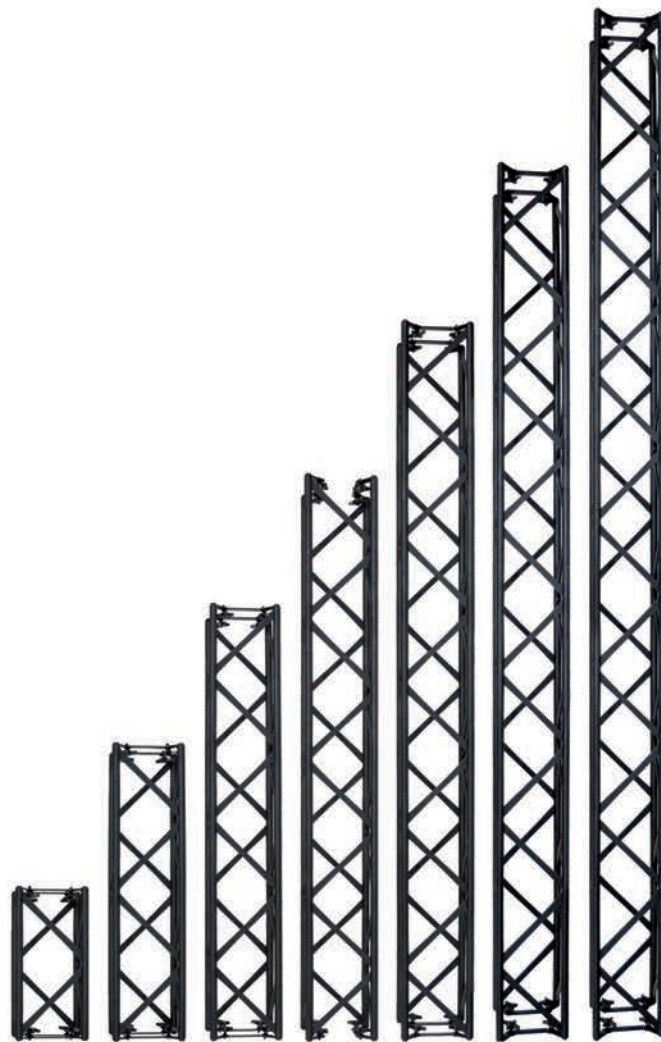

### SCHEDA TECNICA

Codice art.	Descrizione	L.P
MTCRTR30	Crown sezione traliccio dim cm. 15x15 lunghezza cm.30	60
MTCRTR60	Crown sezione traliccio dim cm. 15x15 lunghezza cm.60	84
MTCRTR90	Crown sezione traliccio dim cm. 15x15 lunghezza cm.90	105
MTCRTR120	Crown sezione traliccio dim cm. 15x15 lunghezza cm.120	128
MTCRTR150	Crown sezione traliccio dim cm. 15x15 lunghezza cm.150	143
MTCRTR180	Crown sezione traliccio dim cm. 15x15 lunghezza cm.180	167
MTCRTR210	Crown sezione traliccio dim cm. 15x15 lunghezza cm.210	183

### SCHEDA TECNICA

Cod. art.	Descrizione	L.P
MTCRBASE	Crown base semplice	18
MTCRBAME	Crown base media	24
MTCRBAGR	Crown base grande	32



### SCHEDA TECNICA

Cod. art.	Descrizione	L.P
MTCRCOCU	Crown connettore cubo 15x15x15	41
MTCRCOCR	Crown connettore crociera 15x15	10



### SCHEDA TECNICA

Cod. art.	Descrizione	L.P
MTCRAGSE	Crown aggancio profilo alla struttura (conf.100 pz)	78
MTCRAGEL	Crown aggancio elastico profilo alla struttura (conf.100 pz)	144



## SCHEMA TECNICA

Cod. art.	Descrizione	L.P.
MTCRFA	Crown faretto alogeno 150 watt	86
MTCRCLBR	Crown clip per fissaggio tasche portabrochure	3
MTW110	Tasca portabrochure da parete f.to 1/3 A4 cm.10x21	3
MTW160	Tasca portabrochure da parete f.to A5 cm.15x21	4
MTW230	Tasca portabrochure da parete f.to A4cm.21x30	7

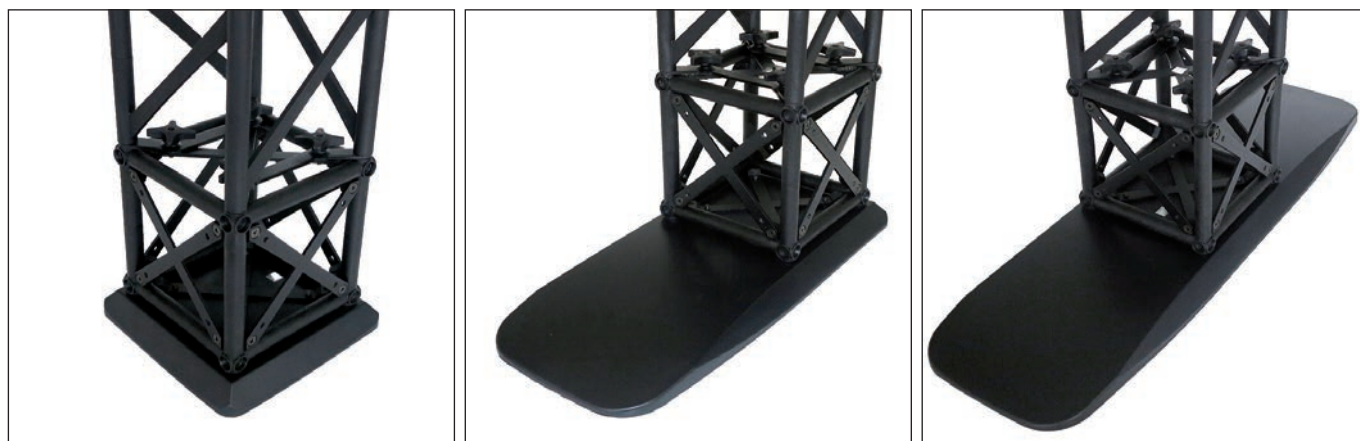
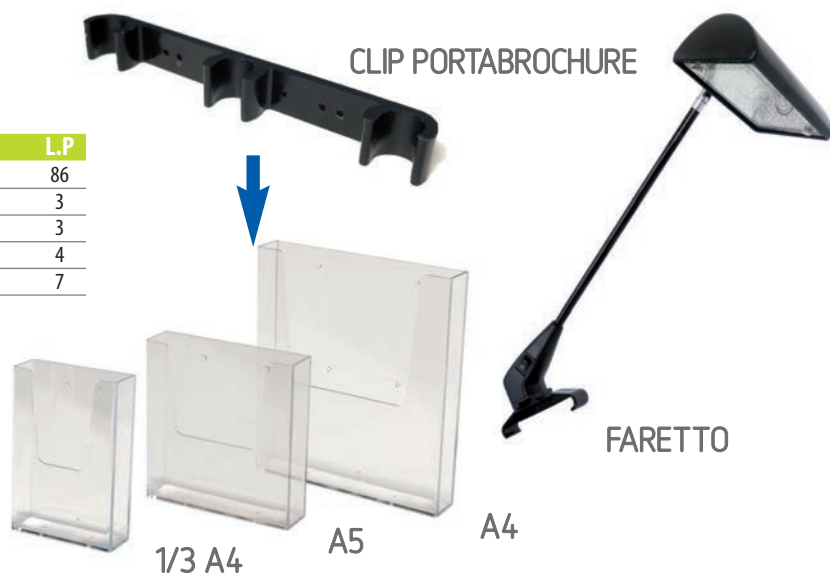

## ISTRUZIONI DI MONTAGGIO





# POP UP TEXTILE

**new  
PRODUCT**

Struttura a ragno richiudibile, realizzata in alluminio, per il tensionamento di grafiche stampate in tessuto. Molto versatile, questa struttura si apre con estrema facilità; un semplice movimento sino all'aggancio delle sicure interne. Il posizionamento del telo avviene mediante velcro. Disponibile nelle versioni dritte, celle 3x3 e 4x3, con dimensioni grafiche di cm. 221x221 (3x3) e cm. 221x293 (4x3). Borsa di trasporto, compresa nel prezzo.

*Resealable spider structure, realized with aluminum, to stretch fabric printed graphics. Very versatile, this structure can be opened really easily, through a fast movement until the internal safety catch hooking. The sheet positioning is possible through velcro. Available in the straight version with 3x3 and 4x3 cells, graphics size cm. 221x221 (3x3) and cm. 221x293 (4x3). Transport bag included with the price.*

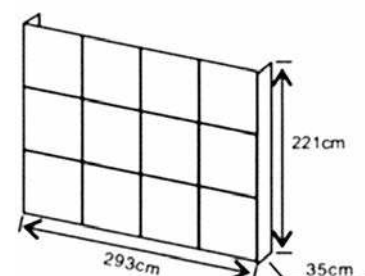
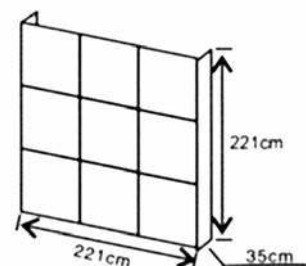

## SCHEMA TECNICA

Cod. art.	Descrizione	Nr. celle	Dim. grafiche cm.	L.P.
DWPOPTXT3X3	Pop-up Textile 3x3	3x3	221x221	450
DWPOPTXT4X3	Pop-up Textile 4x3	4x3	221x293	530

# POP UP POLIONDA

Struttura autoportante realizzata in polionda bianco, con preincisioni per facilitare l'apertura e la chiusura; il pannello centrale è disponibile in due formati, ed il biadesivo in dotazione ne semplifica l'assemblaggio.

*Self-supporting white corrugated material, with pre-in-cision to facilitate the opening and the closing; The central panel is available in two sizes, and the double-sided adhesive supplied simplifies the assembly.*

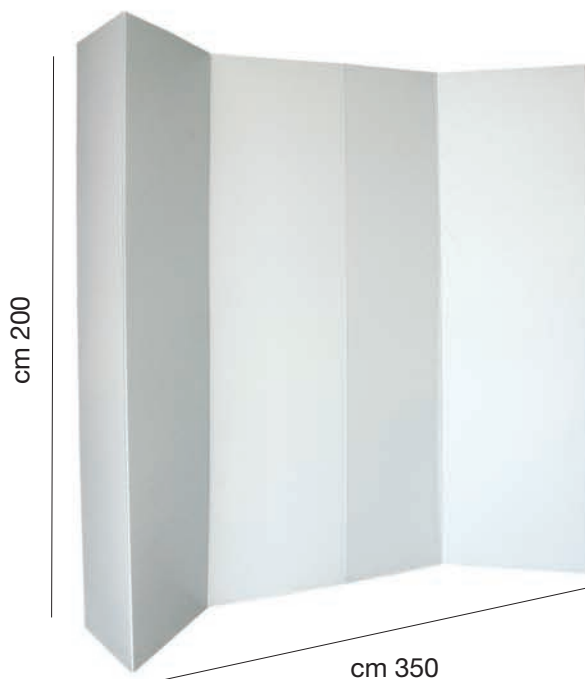
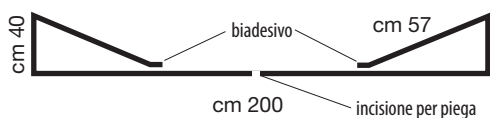
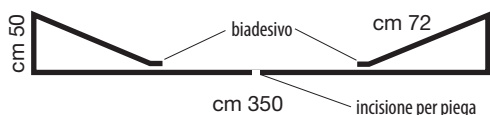

## SCHEMA TECNICA

Cod. art.	Descrizione	L.P.
EUPOPUPPO2020	Pop-Up in polionda bianco f.to cm.200x200	150
EUPOPUPPO2035	Pop-Up in polionda bianco f.to cm.350x200	230

# FISARMONICA CLASSIC & SEPARÈ

Struttura autoportante in polipropilene alveolare bianco, spessore mm. 8, con pre-incisioni ambo i lati per una facile apertura e chiusura. Interamente decorabile, è disponibile in due diverse tipologie.

*Standing structure in white honeycomb polypropylene, thickness mm 8, with pre-incisions on both sides for an easy opening and closing. It can be decorated entirely, it is available in two different types.*



FISARMONICA CLASSIC

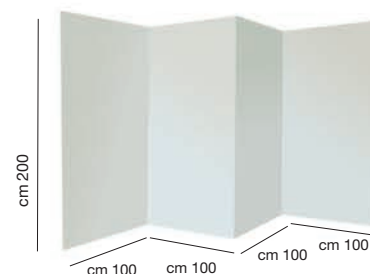
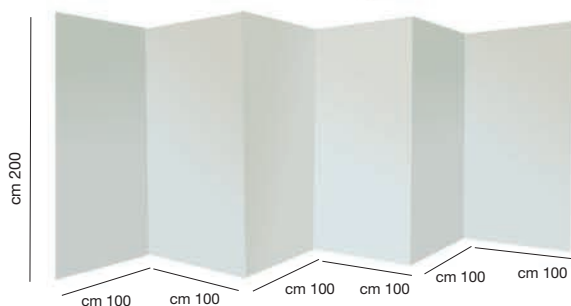

SEPARÈ



cm 75

cm 75

cm 75

cm 75

cm 179

cm 199

## SCHEMA TECNICA

Cod. art.	Descrizione	Dim. imballo	L.P.
EUFISACLA41020	Fisarmonica classic a 4 lati dim. cm. 100x200	100x200x4	220
EUFISACLA61020	Fisarmonica classic a 6 lati dim. cm. 100x200	100x200x6	334
EUFISACLA61024	Fisarmonica Gigante 6 lati dim. cm. 100x245	100x245x6	400
EUSEPA47520	Separè 4 lati dim. cm. 75x200	200x300x6	200

# THE WALL

Serie di telai autoportanti in alluminio anodizzato argento, completi di piedini in gomma silconica antiscivolo e cerniere scomponibili posizionate sui lati; consente di frazionare grandi spazi tipo separè con molta facilità grazie al facile sgancio delle cerniere. Disponibile in diverse dimensioni, è possibile corredarlo con diversi tipi di pannelli pubblicitari, dal PVC al Polionda, dal policarbonato alveolare antiurto al Perspex trasparente, ecc..

*Series of freestanding frames in silver anodized aluminum, complete with silicone feet and separable hinges positioned on the sides; It allows you to divide large spaces like private rooms with ease thanks to easy release hinges. Available in different sizes, it is possible provide it with different types of billboards, from PVC to corrugated material, the polycarbonate shockproof to transparent Perspex, etc ..*



## SCHEDA TECNICA THE WALL PVC

Cod. art.	Descrizione	L.P.
<b>EUWAPVE502</b>	Wall in PVC mm. 5 bianco f.to cm. 50x200	184
<b>EUWAPVE752</b>	Wall in PVC mm. 5 bianco f.to cm. 75x200	208
<b>EUWAPVE102</b>	Wall in PVC mm. 5 bianco f.to cm. 100x200	230

## SCHEDA TECNICA THE WALL POLIONDA

Cod. art.	Descrizione	L.P.
<b>EUWAP0502</b>	Wall in PP mm. 5 bianco f.to cm. 50x200	172
<b>EUWAP0752</b>	Wall in PP mm. 5 bianco f.to cm. 75x200	184
<b>EUWAP0102</b>	Wall in PP mm. 5 bianco f.to cm. 100x200	196

# POP UP QUICK FIX

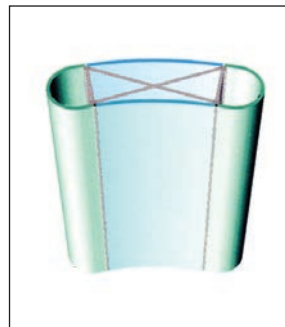
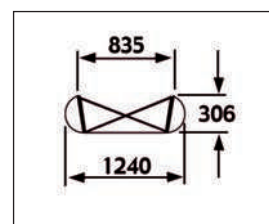
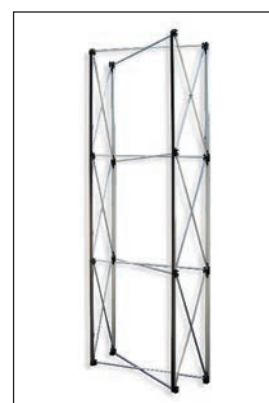
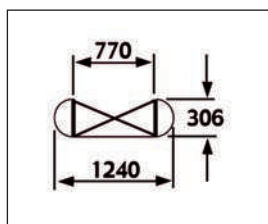

## SCHEDA TECNICA POP-UP QUICK FIX 1X3 DRITTO

Cod. art.	Descrizione	L.P.
BMQUICK1DR	Kit contenente baule porta tutto con struttura a ragno e 12 barre alluminio verticale ed un set di barre in PVC con ganci per le stampe digitali.	400

## SCHEDA TECNICA POP-UP QUICK FIX 1X3 CURVO

Cod. art.	Descrizione	L.P.
BMQUICK1CU	Kit contenente baule porta tutto con struttura a ragno e 12 barre alluminio verticale ed un set di barre in PVC con ganci per le stampe digitali.	400

## DIMENSIONI GRAFICHE

Frontali mm.	Posteriori mm.	Curve finali mm.
h 2225 x b 733	h 2225 x b 733	h 2225 x b 673

## DIMENSIONI GRAFICHE

Frontali mm.	Posteriori mm.	Curve finali mm.
h 2225 x b 673	h 2225 x b 807	h 2225 x b 673

# POP UP QUICK FIX

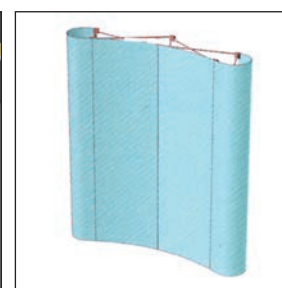
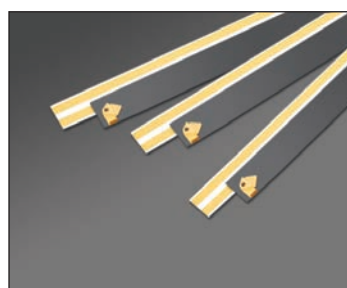
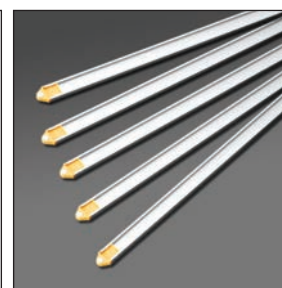
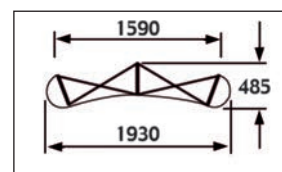
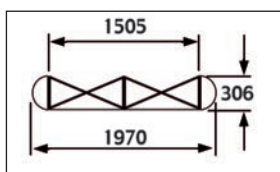
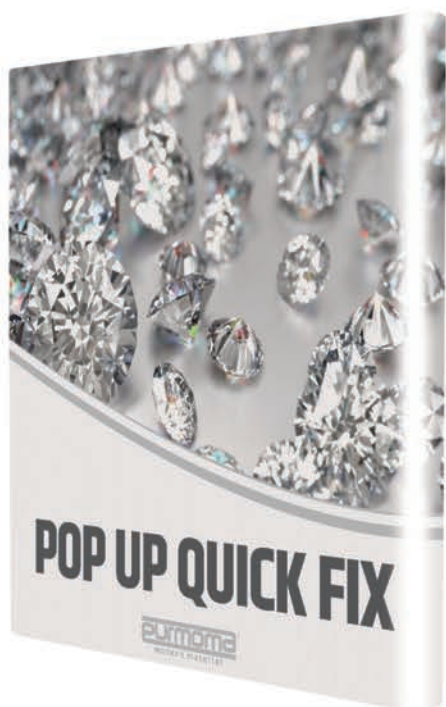

## SCHEDA TECNICA POP-UP QUICK FIX 2X3 DRITTO

Cod. art.	Descrizione	L.P.
<b>BMQUICK2DR</b>	Kit contenente baule porta tutto con struttura a ragno e 15 barre alluminio verticale ed un set di barre in PVC con ganci per le stampe digitali.	550

## SCHEDA TECNICA POP-UP QUICK FIX 2X3 CURVO

Cod. art.	Descrizione	L.P.
<b>BMQUICK2CU</b>	Kit contenente baule porta tutto con struttura a ragno e 15 barre alluminio verticale ed un set di barre in PVC con ganci per le stampe digitali.	550

## DIMENSIONI GRAFICHE

Frontali mm.	Posteriori mm.	Curve finali mm.
h 2225 x b 733	h 2225 x b 733	h 2225 x b 673

## DIMENSIONI GRAFICHE

Frontali mm.	Posteriori mm.	Curve finali mm.
h 2225 x b 673	h 2225 x b 807	h 2225 x b 673

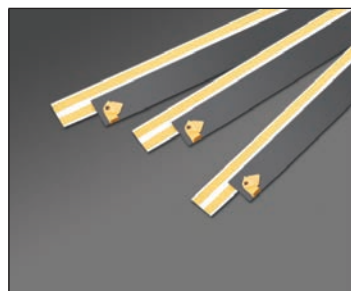
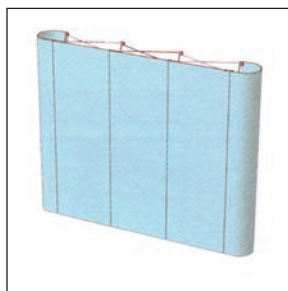
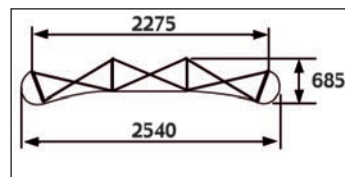
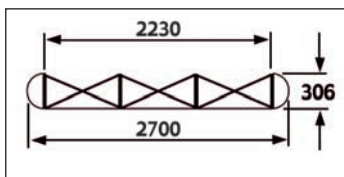

### SCHEDA TECNICA POP-UP QUICK FIX 3X3 DRITTO

Cod. art.	Descrizione	L.P.
<b>BMQUICK3DR</b>	Kit contenente baule porta tutto con struttura a ragno e 18 barre alluminio verticale ed un set di barre in PVC con ganci per le stampe digitali.	680

### SCHEDA TECNICA POP-UP QUICK FIX 3X3 CURVO

Cod. art.	Descrizione	L.P.
<b>BMQUICK3CU</b>	Kit contenente baule porta tutto con struttura a ragno e 18 barre alluminio verticale ed un set di barre in PVC con ganci per le stampe digitali.	680

### DIMENSIONI GRAFICHE

Frontali mm.	Posteriori mm.	Curve finali mm.
h 2225 x b 733	h 2225 x b 733	h 2225 x b 673

### DIMENSIONI GRAFICHE

Frontali mm.	Posteriori mm.	Curve finali mm.
h 2225 x b 673	h 2225 x b 807	h 2225 x b 673

# POP UP QUICK FIX

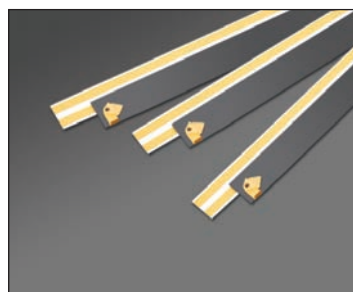
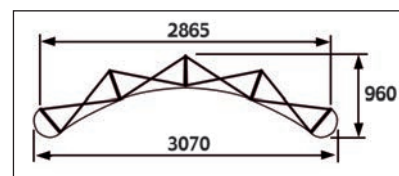
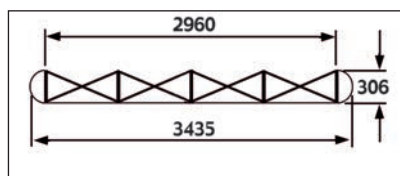
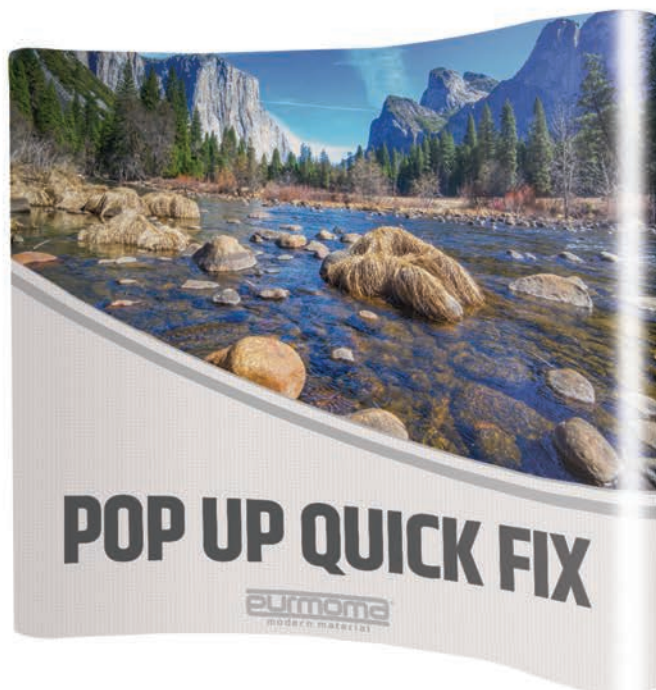
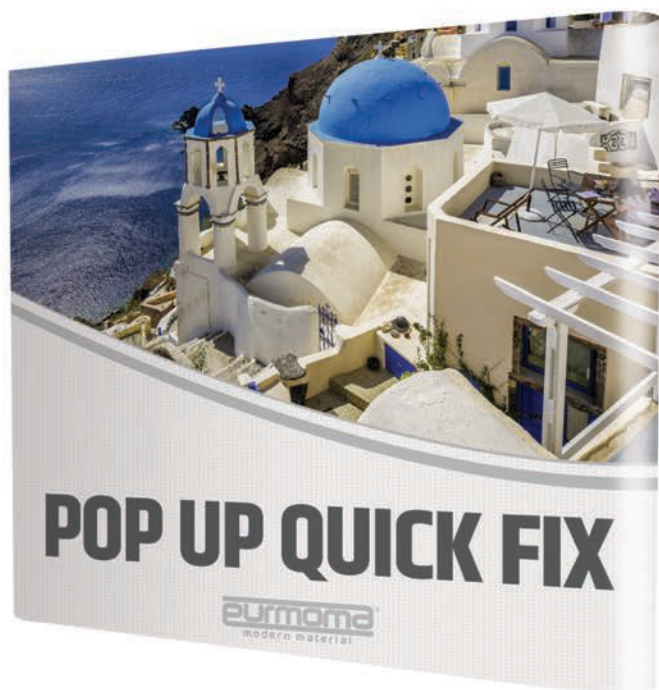

## SCHEDA TECNICA POP-UP QUICK FIX 4X3 DRITTO

Cod. art.	Descrizione	L.P.
<b>BMQUICK4DR</b>	Kit contenente baule porta tutto con struttura a ragno e 21 barre alluminio verticale ed un set di barre in PVC con ganci per le stampe digitali.	800

## DIMENSIONI GRAFICHE

Frontali mm.	Posteriori mm.	Curve finali mm.
h 2225 x b 733	h 2225 x b 733	h 2225 x b 673

## SCHEDA TECNICA POP-UP QUICK FIX 4X3 CURVO

Cod. art.	Descrizione	L.P.
<b>BMQUICK4CU</b>	Kit contenente baule porta tutto con struttura a ragno e 21 barre alluminio verticale ed un set di barre in PVC con ganci per le stampe digitali.	800

## DIMENSIONI GRAFICHE

Frontali mm.	Posteriori mm.	Curve finali mm.
h 2225 x b 673	h 2225 x b 807	h 2225 x b 673



# RICAMBI E ACCESSORI



Cod. art.	Descrizione	L.P.
<b>BMQFBAR</b>	Set 3 pezzi Barre magnetiche	23



Cod. art.	Descrizione	L.P.
<b>QLMAG12</b>	Rtl. magnet. adesivo mm. 12x30 m.	56



Cod. art.	Descrizione	L.P.
<b>BMQFPLAST673</b>	Fascia ades.per aggancio grafica cm 67,3	7
<b>BMQFPLAST733</b>	Fascia ades. per aggancio grafica cm 73,3	8
<b>BMQFPLAST807</b>	Fascia ades. per aggancio grafica cm 80,7	9



Cod. art.	Descrizione	L.P.
<b>BMQFFAR</b>	Coppia fari a Led	90



Cod. art.	Descrizione	L.P.
<b>BMQFSIC</b>	Barra magnetica interna	8



Cod. art.	Descrizione	L.P.
<b>BMQFBAU</b>	Baule da trasporto + top tavolo	465

# SUPPORTI PER POP UP

## POLIESTERE FILM STOP-LIGHT PER POP-UP

Film in poliestere dedicato all'allestimento di pop-up e di tutti gli altri display ove necessita un supporto più rigido. Lato stampa bianco, finitura lucida o opaca, retro grigio antistatico stop-light. Compatibile con inchiostri solvente ed eco-solvente. Perfettamente stabile, non si deforma.

## POLYESTER FILM STOP-LIGHT FOR POP-UP

*Polyester film dedicated to the preparation of pop-up and all other displays where is necessary a stiffer support. Print side white, glossy or matte finish, antistatic grey back stop-light.*

*Compatible with solvent and eco-solvent inks. Perfectly stable, it does not warp.*

### SCHEDA TECNICA

Cod. art.	Colore	Finitura	Spess. My	Dimensioni rotolo		L.P.
				Hcm	Lmt	
<b>KCPOPSLMA9130</b>	bianco	opaca	290	91.4	30	506
<b>KCPOPSLMA1230</b>	bianco	opaca	290	127	30	772



## POLIESTERE COMPOSTO RETRO GRIGIO PER POP-UP My 500

Nuovo supporto economico per roller da 500 my, finitura leggermente gofrata, non necessita di laminazione, superficie antistatica. *New economic support for roller 500 my thickness, slightly embossed finishing, no need of lamination, anti-static surface.*

### SCHEDA TECNICA

Codice art.	Colore	Finitura	Spess.My	Dimensioni H cm	Rotolo L mt	L.P.
<b>KCSU5009130</b>	bianco	goffrata	500	91.4	30	422

## FILM DI LAMINAZIONE

Film in PVC incolore, superficie gofrata; ideale per proteggere le grafiche dai raggi UV e da graffi accidentali. Le alte prestazioni del collante in poliaccrilico a solvente, garantisce un'ottima adesione su ogni superficie.

*PVC film colorless, embossed surface; ideal to protect graphics from UV rays and accidental scratches. The high performance of the adhesive in a solvent polyacrylate, excellent adhesion to any surface.*

### SCHEDA TECNICA

Cod. art.	Finitura	Collante	Spess. My	Dimensioni rotolo		L.P.
				Hcm	Lmt	
<b>OF210S095</b>	goffrata	solvente	70	95	50	269,50
<b>OF210S0105</b>	goffrata	solvente	70	105	50	297,50
<b>OF210S0130</b>	goffrata	solvente	70	130	50	368,50



# ORAFOL

## AUTOADESIVI

### SPECIALI



### STAMPA DIGITALE



### STAMPA SERIGRAFICA E OFFSET



# ORAFOL

### INTAGLIO PLOTTER



### DECORAZIONE VEICOLI E CARAVAN



## BIADESIVI INDUSTRIALI



## FILM DI PROTEZIONE



## DECORATIVI PER VETRI



## DESIGN DECORATION



## TRASLUCENT PER INSEGNE



## RIFRANGENTI E FLUORESCENTI



# CONDIZIONI GENERALI DI VENDITA

1) I prezzi del presente listino sono stati fissati in base ai costi attuali delle Materie Prime, del danaro e del lavoro: pertanto potranno subire variazioni anche senza preventiva comunicazione.

2) Pagamenti: i pagamenti devono essere effettuati alla Eurmoma s.r.l. alle condizioni indicate.  
Ogni ritardo nel pagamento darà luogo alla decorrenza degli interessi di mora.

3) Consegna: il venditore declina ogni responsabilità per ritardata o mancata consegna dovuta a forza maggiore, sciopero, serratte, incendio, mancanza di materia prima, manodopera insufficiente, provvedimenti di autorità locali o governative, messa fuori uso dell'attrezzatura produttiva per qualsiasi motivo al di fuori del proprio controllo.  
In tutti i casi di cambiamento della situazione del cliente (incapacità o fallimenti, sospensione di pagamenti, scioglimenti o modificazioni di

società, ecc.) ci riteniamo esonerati dall'impegno di effettuare le consegne.

4) Trasporto: la merce, anche se spedita in porto franco, viaggia sempre a rischio e pericolo del committente. Eventuali resi autorizzati dalla Casa debbono essere ritornati in porto franco.

5) Controllo: appena ritirata la merce si prega di esaminarla e di verificarne il peso, i pezzi e le confezioni perchè non si accettano reclami trascorsi otto giorni dall'avvenuta consegna.

6) Il contraente dà atto che in caso di mancato o ritardato pagamento sarà dovuto alla Eurmoma s.r.l. l'interesse a tasso ultra legale.

7) Controversie: per ogni controversia è competente il foro di Roma.



**eurmoma**<sup>®</sup>  
modern material

**Ufficio Ordini e Magazzino:** Ciampino (Roma) • Via Salvatore Carnevale 10A • Tel. 06 7230087 • Fax 06 7234367

**Stabilimento Produzione:** Roma • Via del Casale Paoloni, 15 • Tel. 06 7230087

**EURMOMA NORD:** Turate (COMO) • Via Isonzo, 6/b (Sironi Maurizio) • Mob. 349 8272000

Website: [www.eurmoma.it](http://www.eurmoma.it) • E-mail: [info@eurmoma.it](mailto:info@eurmoma.it)

**[www.imieigioielli.com](http://www.imieigioielli.com)**